

BN12 Specifications

Inside Rotor
Brushless Motors

BN12 SPECIFICATIONS - Continuous Stall Torque 2.4 - 8.6 oz-in (0.0170 - 0.0607 Nm) Peak Torque 13 - 77 oz-in (0.0918 - 0.5437 Nm)

Part Number*	BN12-13AF- <input type="checkbox"/> <input type="checkbox"/> <input type="checkbox"/> <input type="checkbox"/> <input type="checkbox"/>			BN12-18AF- <input type="checkbox"/> <input type="checkbox"/> <input type="checkbox"/> <input type="checkbox"/> <input type="checkbox"/>			BN12-23AF- <input type="checkbox"/> <input type="checkbox"/> <input type="checkbox"/> <input type="checkbox"/> <input type="checkbox"/>			BN12-28AF- <input type="checkbox"/> <input type="checkbox"/> <input type="checkbox"/> <input type="checkbox"/> <input type="checkbox"/>			
	01	02	03	01	02	03	01	02	03	01	02	03	
Winding Code**													
	L = Length	inches 1.30			1.80			2.30			2.80		
	millimeters 33.02			45.72			58.42			71.12			
Terminal Voltage	volts DC	12.0	24.0	36.0	12.0	24.0	36.0	12.0	24.0	36.0	12.0	24.0	36.0
Peak Torque	oz-in	13.0	13.0	14.0	37.0	37.0	39.0	58.0	58.0	61.0	77.0	77.0	72.0
	Nm	0.0918	0.0918	0.0989	0.2613	0.2613	0.2754	0.4096	0.4096	0.4308	0.5437	0.5437	0.5084
Continuous Stall Torque	oz-in	2.4	2.4	2.4	4.9	5.0	5.0	6.9	6.9	6.9	8.3	8.6	8.6
	Nm	0.0169	0.0169	0.0169	0.0346	0.0353	0.0353	0.0487	0.0487	0.0487	0.0586	0.0607	0.0607
Rated Speed	RPM	13027.0	12736.0	13753.0	11928.0	11448.0	12320.0	10604.0	10601.0	11489.0	11036.0	10253.0	9529.0
	rad/sec	1364	1334	1440	1249	1199	1290	1110	1110	1203	1156	1074	998
Rated Torque	oz-in	1.8	1.8	1.8	3.5	3.6	3.5	5.0	5.0	4.7	5.4	5.9	6.2
	Nm	0.0127	0.0127	0.0127	0.0247	0.0254	0.0247	0.0353	0.0353	0.0332	0.0381	0.0417	0.0438
Rated Current	Amps	2.26	1.13	0.77	3.49	1.76	1.20	4.32	2.16	1.46	4.81	2.46	1.61
Rated Power	watts	17.3	17.0	18.3	30.9	30.5	31.9	39.2	39.2	39.9	44.1	44.7	43.7
Torque Sensitivity	oz-in/amp	1.02	2.06	2.95	1.24	2.56	3.64	1.42	2.84	4.01	1.41	2.99	4.75
	Nm/amp	0.0072	0.0145	0.0208	0.0088	0.0181	0.0257	0.0100	0.0201	0.0283	0.0100	0.0211	0.0335
Back EMF	volts/KRPM	0.75	1.53	2.18	0.92	1.89	2.69	1.05	2.10	2.96	1.04	2.21	3.51
	volts/rad/sec	0.0072	0.0145	0.0208	0.0088	0.0181	0.0257	0.0100	0.0201	0.0283	0.0100	0.0211	0.0335
Terminal Resistance	ohms	0.953	3.89	7.85	0.403	1.67	3.36	0.294	1.18	2.36	0.219	0.934	2.36
Terminal Inductance	mH	0.254	1.100	2.210	0.181	0.742	1.460	0.172	0.692	1.374	0.128	0.447	1.220
Motor Constant	oz-in/sq.rt.watt	1.04	1.04	1.05	1.95	1.98	1.99	2.62	2.61	2.61	3.01	3.09	3.09
	Nm/sq.rt.watt	0.00738	0.00738	0.00744	0.01379	0.01399	0.01402	0.01849	0.01846	0.01843	0.02128	0.02185	0.02183
Rotor Inertia	oz-in-sec ² x10 ⁻³	0.040	0.040	0.040	0.080	0.080	0.080	0.120	0.120	0.120	0.16	0.16	0.16
	g-cm ²	2.82	2.82	2.82	5.65	5.65	5.65	8.47	8.47	8.47	11.3	11.3	11.3
Weight	oz	3.6	3.6	3.6	5.5	5.5	5.5	7.3	7.3	7.3	9.1	9.2	9.2
	g	102.2	102.2	102.2	156.2	156.2	156.2	207.3	207.3	207.3	258.4	261.3	261.3
# of Poles		8.0	8.0	8.0	8.0	8.0	8.0	8.0	8.0	8.0	8.0	8.0	8.0
Timing		120°	120°	120°	120°	120°	120°	120°	120°	120°	120°	120°	120°
Mech. Time Constant	ms	5.2	5.2	5.1	3.0	2.9	2.9	2.5	2.5	2.5	2.5	2.4	2.4
Electrical Time Constant	ms	0.14	0.14	0.14	0.24	0.25	0.25	0.29	0.29	0.29	0.29	0.31	0.31
Thermal Resistivity	deg. C/watt	10.7	10.3	11.2	9.5	8.9	9.3	8.3	8.3	8.3	7.7	7.3	7.4
Speed/Torque Gradient	rpm/oz-in	1245.8	1234.2	1220.6	353.3	345.2	343.2	197.2	197.9	198.8	149.3	141.3	141.6

- Notes:
- Motor mounted to a 4 x 4 x 1/4 inches aluminum plate, still air.
 - Maximum winding temperature of 155°C.
 - Typical electrical specifications at 25°C.
 - Motor Terminal Voltages are representative only; motors may be operated at voltages other than those listed in the table. For assistance please contact our applications engineer.
 - For MS (military style) connector, please specify connector housing and terminal.
 - Data for informational purposes only. Should not be considered a binding performance agreement. For specific applications, please contact the factory.

*Many other custom mechanical options are available – consult factory.
**Many other winding options are available – consult factory.

Select your options below and place their code in its corresponding block as shown on page 5.

- | | | |
|--------------------------------------|---|--|
| <input type="checkbox"/> TERMINATION | <input type="checkbox"/> FEEDBACK OPTIONS | <input type="checkbox"/> OTHER OPTIONS |
| L – Leads (std) | H – Hall Effect (std) | E – Encoder |
| C – Connector | R – Resolver | G – Gearhead |
| M – MS connector | S – Sensorless | |

BN12 Typical Outline

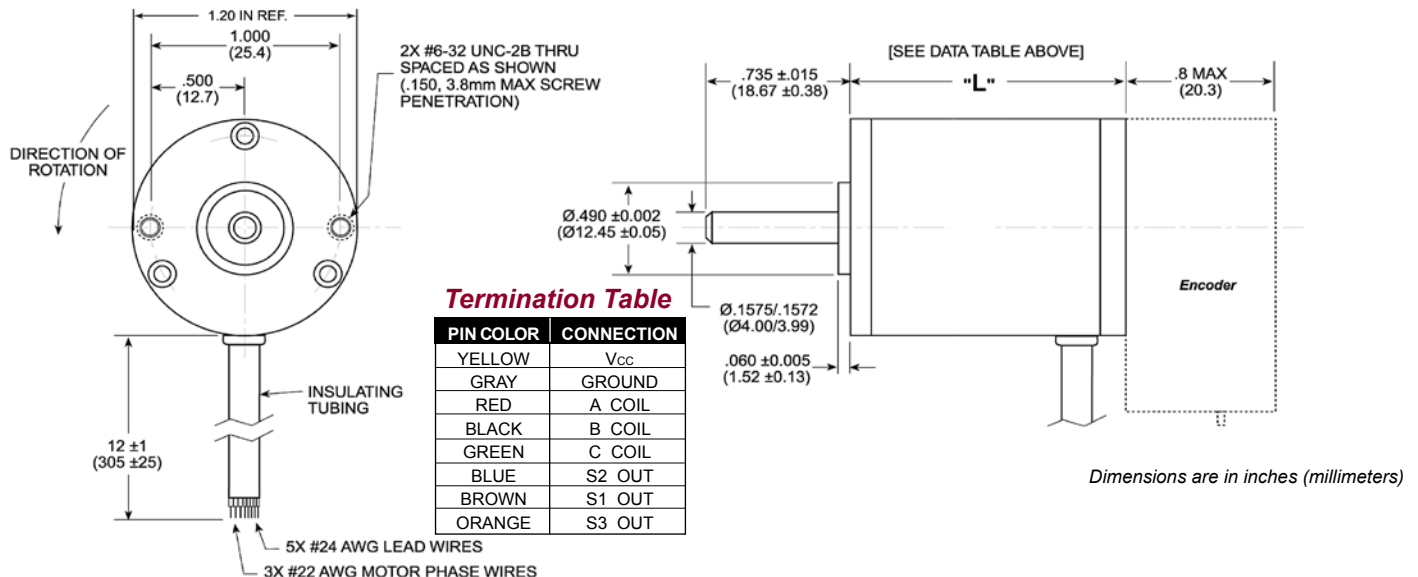

REVISED 05/19

BN12 Performance Curves

BN12 Performance Curves

BN12-13AF-01: Continuous & Intermittent Operation at 12 Volt DC

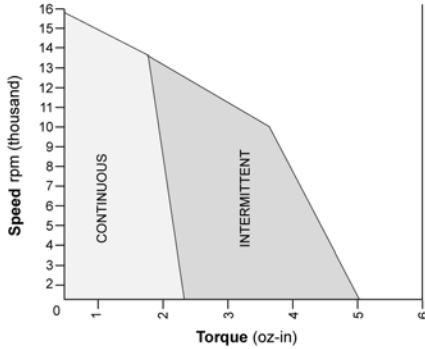

BN12-13AF-02: Continuous & Intermittent Operation at 24 Volt DC

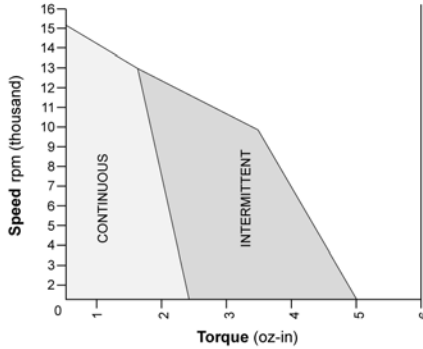

BN12-13AF-03: Continuous & Intermittent Operation at 36 Volt DC

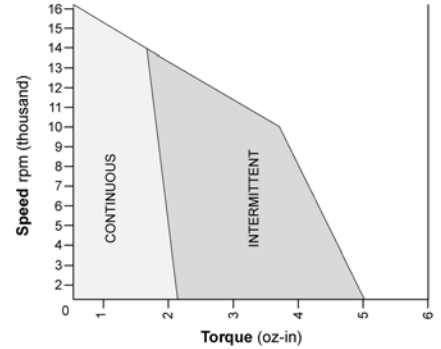

BN12-18AF-01: Continuous & Intermittent Operation at 12 Volt DC

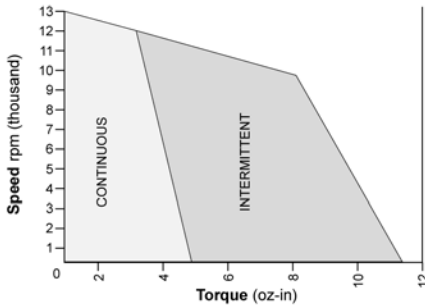

BN12-18AF-02: Continuous & Intermittent Operation at 24 Volt DC

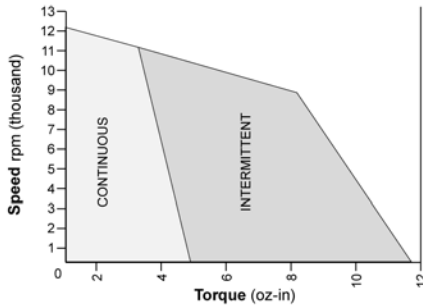

BN12-18AF-03: Continuous & Intermittent Operation at 36 Volt DC

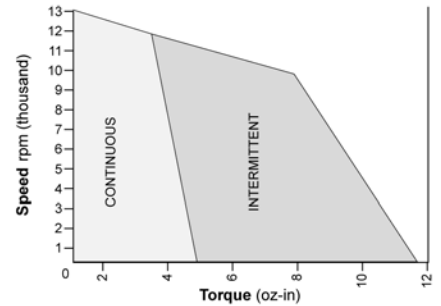

BN12-23AF-01: Continuous & Intermittent Operation at 12 Volt DC

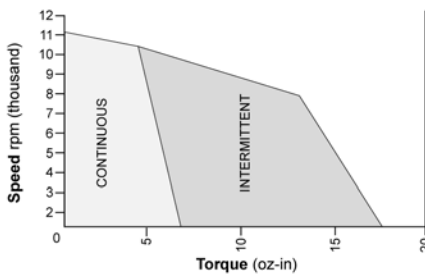

BN12-23AF-02: Continuous & Intermittent Operation at 24 Volt DC

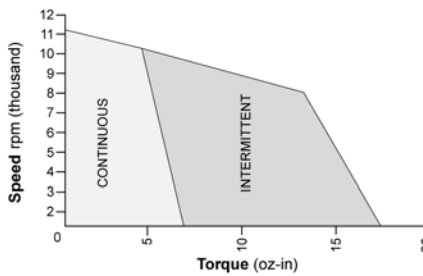

BN12-23AF-03: Continuous & Intermittent Operation at 36 Volt DC

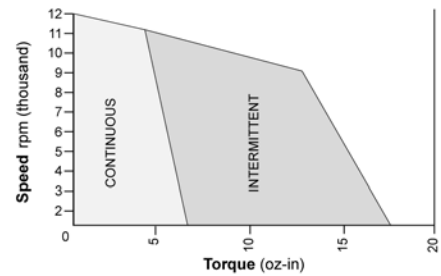

BN12-28AF-01: Continuous & Intermittent Operation at 12 Volt DC

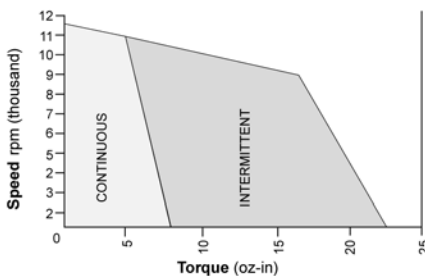

BN12-28AF-02: Continuous & Intermittent Operation at 24 Volt DC

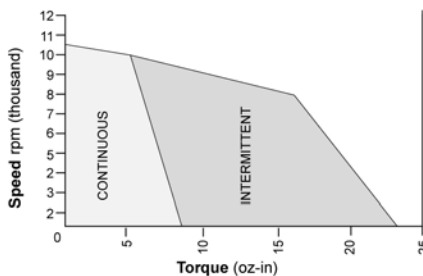

BN12-28AF-03: Continuous & Intermittent Operation at 36 Volt DC

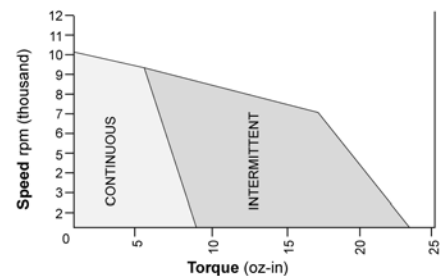

Note: Intermittent operation is based on a 20% duty cycle of one minute on, four minutes off.
Please contact the factory regarding the duty cycle of your application.

BN12 EU Specifications

Inside Rotor
Brushless Motors

BN12 EU SPECIFICATIONS -

Continuous Stall Torque 2.4 - 8.6 oz-in (0.0170 - 0.0587 Nm)
Peak Torque 13 - 77 oz-in (0.0918 - 0.544 Nm)

Part Number*		BN12-13EU- <input type="checkbox"/> <input type="checkbox"/> <input type="checkbox"/> <input type="checkbox"/>			BN12-18EU- <input type="checkbox"/> <input type="checkbox"/> <input type="checkbox"/> <input type="checkbox"/>			BN12-23EU- <input type="checkbox"/> <input type="checkbox"/> <input type="checkbox"/> <input type="checkbox"/>			BN12-28EU- <input type="checkbox"/> <input type="checkbox"/> <input type="checkbox"/> <input type="checkbox"/>		
Winding Code**		01	02	03	01	02	03	01	02	03	01	02	03
L = Length	inches	1.30			1.80			2.30			2.80		
	millimeters	33.02			45.72			58.42			71.12		
Terminal Voltage	volts DC	12	24	36	12	24	36	12	24	36	12	24	36
Peak Torque	oz-in	13	13	14	37	37	39	58	58	61	77	77	72
	Nm	0.0918	0.0918	0.0989	0.262	0.262	0.276	0.410	0.410	0.431	0.544	0.544	0.509
Continuous Stall Torque	oz-in	2.4	2.4	2.4	4.9	5.0	5.0	6.9	6.9	6.9	8.3	8.6	8.6
	Nm	0.0170	0.0170	0.0170	0.0346	0.0354	0.0354	0.0488	0.0488	0.0488	0.0587	0.0587	0.0587
Rated Speed	RPM	13027	12736	13753	11928	11448	12320	10604	10601	11489	11036	10253	9529
	rad/sec	1364	1333	1440	1249	1198	1290	1110	1110	1203	1155	1073	997
Rated Torque	oz-in	1.80	1.80	1.80	3.50	3.60	3.50	5.00	5.00	4.70	5.40	5.90	6.20
	Nm	0.0127	0.0127	0.0127	0.0248	0.0255	0.0248	0.0354	0.0354	0.0332	0.0382	0.0417	0.0438
Rated Current	Amps	2.26	1.13	0.77	3.49	1.76	1.20	4.32	2.16	1.46	4.81	2.46	1.61
Rated Power	watts	17.3	17.0	18.3	30.9	30.5	31.9	39.2	39.2	39.9	44.1	44.7	43.7
Torque Sensitivity	oz-in/amp	1.02	2.06	2.95	1.24	2.56	3.64	1.42	2.84	4.01	1.41	2.99	4.75
	Nm/amp	0.0072	0.0146	0.0209	0.0088	0.0180	0.0257	0.0101	0.0201	0.0284	0.0100	0.0212	0.0336
Back EMF	volts/KRPM	0.75	1.53	2.18	0.92	1.89	2.69	1.05	2.10	2.96	1.04	2.21	3.51
	volts/rad/sec	0.0072	0.0146	0.0209	0.0088	0.0180	0.0257	0.0101	0.0201	0.0284	0.0100	0.0212	0.0336
Terminal Resistance	ohms	0.953	3.89	7.85	0.403	1.67	3.36	0.294	1.18	2.36	0.219	0.934	2.36
Terminal Inductance	mH	0.254	1.100	2.210	0.181	0.742	1.460	0.172	0.692	1.374	0.128	0.447	1.220
Motor Constant	oz-in/sq.rt.watt	1.0	1.1	1.1	2.0	2.0	2.0	2.6	2.6	2.6	3.0	3.1	3.1
	Nm/sq.rt.watt	0.0071	0.0078	0.0078	0.0142	0.0142	0.0142	0.0184	0.0184	0.0184	0.0212	0.0219	0.0219
Rotor Inertia	oz-in-sec ²	4.0E-05	4.0E-05	4.0E-05	8.0E-05	8.0E-05	8.0E-05	1.2E-04	1.2E-04	1.2E-04	1.6E-04	1.6E-04	1.6E-04
	g-cm ²	2.83	2.83	2.83	5.65	5.65	5.65	8.48	8.48	8.48	11.3	11.3	11.3
Weight	oz	3.6	3.6	3.6	5.5	5.5	5.5	7.3	7.3	7.3	9.1	9.2	9.2
	g	102	102	102	156	156	156	207	207	207	258	261	261

Notes:

- Motor mounted to a 4 x 4 x 1/4 inches aluminum plate, still air.
- Maximum winding temperature of 155°C.
- Typical electrical specifications at 25°C.
- Motor Terminal Voltages are representative only; motors may be operated at voltages other than those listed in the table. For assistance please contact our applications engineer.
- For MS (military style) connector, please specify connector housing and terminal.
- Data for informational purposes only. Should not be considered a binding performance agreement. For specific applications, please contact the factory.

*Many other custom mechanical options are available – consult factory.

**Many other winding options are available – consult factory.

Select your options below and place their code in its corresponding block as shown on page 5.

- | | | |
|---|--|---|
| <input type="checkbox"/> TERMINATION | <input type="checkbox"/> FEEDBACK OPTIONS | <input type="checkbox"/> OTHER OPTIONS |
| L – Leads (std) | H – Hall Effect (std) | E – Encoder |
| C – Connector | R – Resolver | G – Gearhead |
| M – MS connector | S – Sensorless | |

BN12 EU Typical Outline

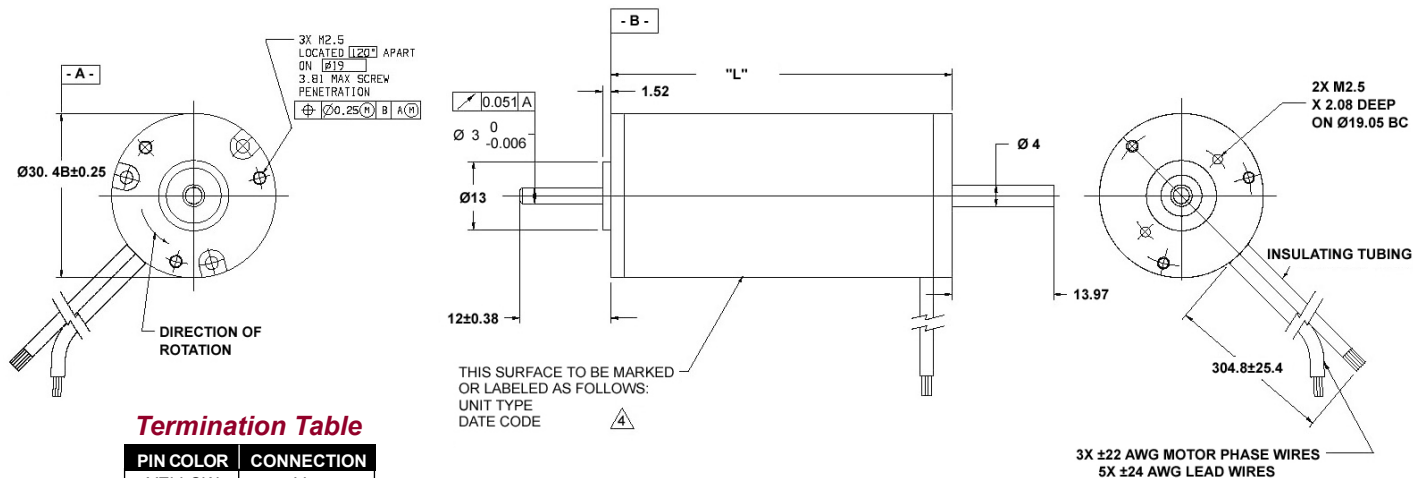

Termination Table

PIN COLOR	CONNECTION
YELLOW	V _{CC}
GRAY	GROUND
RED	A COIL
BLACK	B COIL
GREEN	C COIL
BLUE	S2 OUT
BROWN	S1 OUT
ORANGE	S3 OUT

Dimensions are in millimeters

BN12 EU Performance Curves

BN12 EU Performance Curves

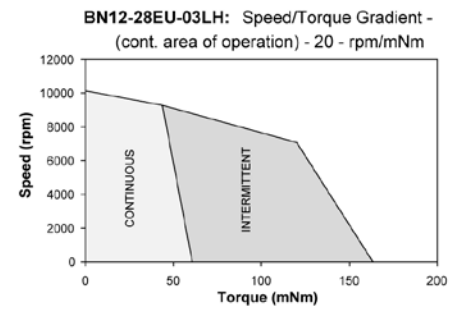
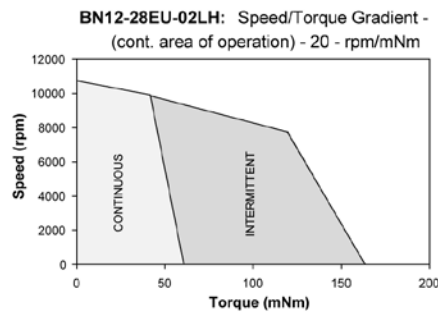
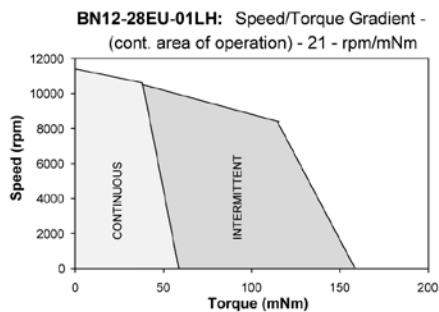
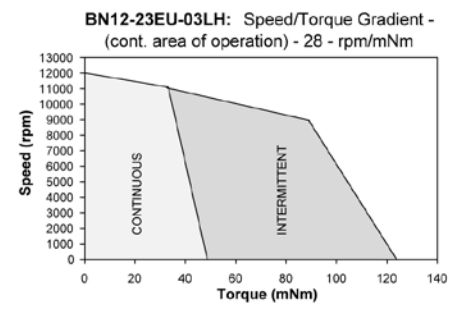
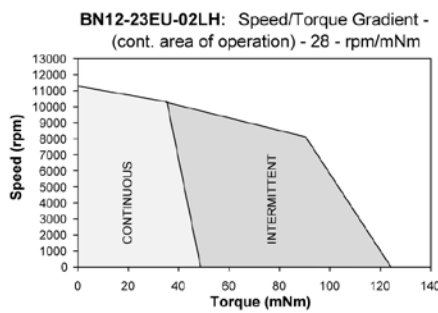
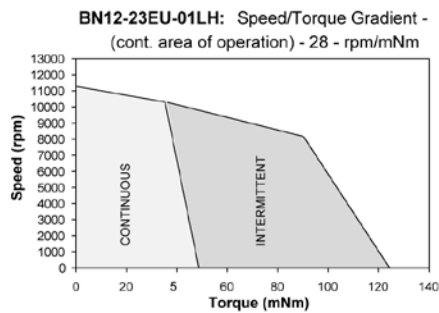
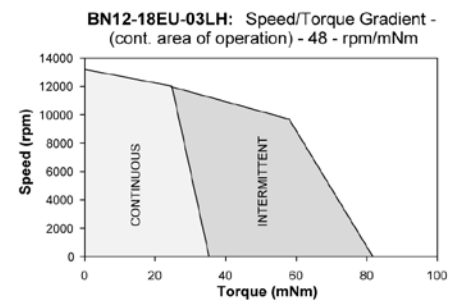
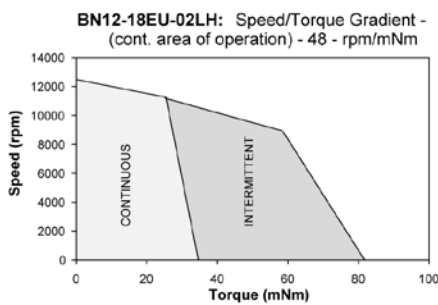
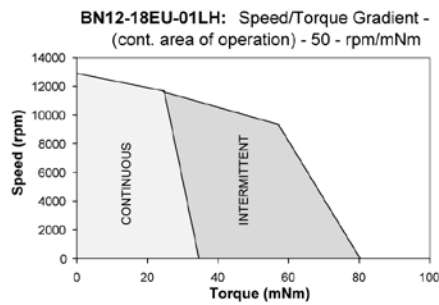
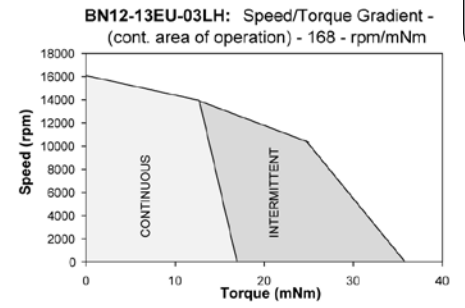
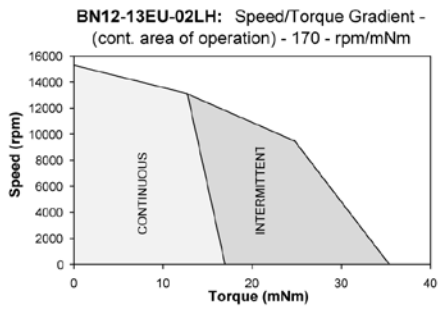
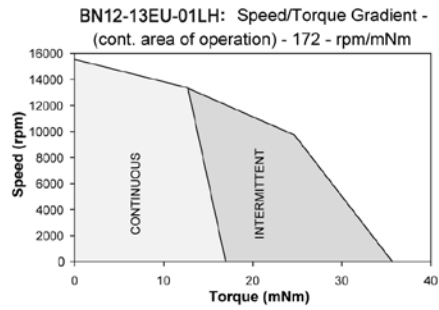

Note: Intermittent operation is based on a 20% duty cycle of one minute on, four minutes off.
Please contact the factory regarding the duty cycle of your application.

BN12 IP65 Specifications

Inside Rotor
Brushless Motors

BN12 IP65 SPECIFICATIONS - Continuous Stall Torque 2.4 - 8.6 oz-in (0.0170 - 0.0607 Nm)
Peak Torque 13 - 77 oz-in (0.0918 - 0.5437 Nm)

Part Number*		BN12-13IP- <input type="checkbox"/> <input type="checkbox"/> <input checked="" type="checkbox"/> <input checked="" type="checkbox"/> <input checked="" type="checkbox"/>			BN12-18IP- <input type="checkbox"/> <input type="checkbox"/> <input checked="" type="checkbox"/> <input checked="" type="checkbox"/> <input checked="" type="checkbox"/>			BN12-23IP- <input type="checkbox"/> <input type="checkbox"/> <input checked="" type="checkbox"/> <input checked="" type="checkbox"/> <input checked="" type="checkbox"/>			BN12-28IP- <input type="checkbox"/> <input type="checkbox"/> <input checked="" type="checkbox"/> <input checked="" type="checkbox"/> <input type="checkbox"/>		
Winding Code**		01	02	03	01	02	03	01	02	03	01	02	03
L = Length	inches	1.82			2.32			2.82			3.32		
	millimeters	46.2			58.9			71.6			84.3		
Terminal Voltage	volts DC	12.0	24.0	36.0	12.0	24.0	36.0	12.0	24.0	36.0	12.0	24.0	36.0
Peak Torque	oz-in	13.0	13.0	14.0	37.0	37.0	39.0	58.0	58.0	61.0	77.0	77.0	72.0
	Nm	0.0918	0.0918	0.0989	0.2613	0.2613	0.2754	0.4096	0.4096	0.4308	0.5437	0.5437	0.5084
Continuous Stall Torque	oz-in	2.4	2.4	2.4	4.9	5.0	5.0	6.9	6.9	6.9	8.3	8.6	8.6
	Nm	0.0169	0.0169	0.0169	0.0346	0.0353	0.0353	0.0487	0.0487	0.0487	0.0586	0.0607	0.0607
Rated Speed	RPM	13027.0	12736.0	13753.0	11928.0	11448.0	12320.0	10604.0	10601.0	11489.0	11036.0	10253.0	9529.0
	rad/sec	1364	1334	1440	1249	1199	1290	1110	1110	1203	1156	1074	998
Rated Torque	oz-in	1.8	1.8	1.8	3.5	3.6	3.5	5.0	5.0	4.7	5.4	5.9	6.2
	Nm	0.0127	0.0127	0.0127	0.0247	0.0254	0.0247	0.0353	0.0353	0.0332	0.0381	0.0417	0.0438
Rated Current	Amps	2.26	1.13	0.77	3.49	1.76	1.20	4.32	2.16	1.46	4.81	2.46	1.61
Rated Power	watts	17.3	17.0	18.3	30.9	30.5	31.9	39.2	39.2	39.9	44.1	44.7	43.7
Torque Sensitivity	oz-in/amp	1.02	2.06	2.95	1.24	2.56	3.64	1.42	2.84	4.01	1.41	2.99	4.75
	Nm/amp	0.0072	0.0145	0.0208	0.0088	0.0181	0.0257	0.0100	0.0201	0.0283	0.0100	0.0211	0.0335
Back EMF	volts/KRPM	0.75	1.53	2.18	0.92	1.89	2.69	1.05	2.10	2.96	1.04	2.21	3.51
	volts/rad/sec	0.0072	0.0145	0.0208	0.0088	0.0181	0.0257	0.0100	0.0201	0.0283	0.0100	0.0211	0.0335
Terminal Resistance	ohms	0.953	3.89	7.85	0.403	1.67	3.36	0.294	1.18	2.36	0.219	0.934	2.36
Terminal Inductance	mH	0.254	1.100	2.210	0.181	0.742	1.460	0.172	0.692	1.374	0.128	0.447	1.220
Motor Constant	oz-in/sq.rt.watt	1.04	1.04	1.05	1.95	1.98	1.99	2.62	2.61	2.61	3.01	3.09	3.09
	Nm/sq.rt.watt	0.00738	0.00738	0.00744	0.01379	0.01399	0.01402	0.01849	0.01846	0.01843	0.02128	0.02185	0.02183
Rotor Inertia	oz-in-sec ² x10 ⁻³	0.040	0.040	0.040	0.080	0.080	0.080	0.120	0.120	0.120	0.16	0.16	0.16
	g-cm ²	2.82	2.82	2.82	5.65	5.65	5.65	8.47	8.47	8.47	11.3	11.3	11.3
Weight	oz	3.6	3.6	3.6	5.5	5.5	5.5	7.3	7.3	7.3	9.1	9.2	9.2
	g	102.2	102.2	102.2	156.2	156.2	156.2	207.3	207.3	207.3	258.4	261.3	261.3
# of Poles		8.0	8.0	8.0	8.0	8.0	8.0	8.0	8.0	8.0	8.0	8.0	8.0
Timing		120°	120°	120°	120°	120°	120°	120°	120°	120°	120°	120°	120°
Mech. Time Constant	ms	5.2	5.2	5.1	3.0	2.9	2.9	2.5	2.5	2.5	2.5	2.4	2.4
Electrical Time Constant	ms	0.14	0.14	0.14	0.24	0.25	0.25	0.29	0.29	0.29	0.29	0.31	0.31
Thermal Resistivity	deg. C/watt	10.7	10.3	11.2	9.5	8.9	9.3	8.3	8.3	8.3	7.7	7.3	7.4
Speed/Torque Gradient	rpm/oz-in	1245.8	1234.2	1220.6	353.3	345.2	343.2	197.2	197.9	198.8	149.3	141.3	141.6

- Notes:
- Motor mounted to a 4 x 4 x 1/4 inches aluminum plate, still air.
 - Maximum winding temperature of 155°C.
 - Typical electrical specifications at 25°C.
 - Motor Terminal Voltages are representative only; motors may be operated at voltages other than those listed in the table. For assistance please contact our applications engineer.
 - Calculated (theoretical) speed/torque gradient.
 - For MS (military style) connector, please specify connector housing and terminal.
 - Data for informational purposes only. Should not be considered a binding performance agreement. For specific applications, please contact the factory.

*Many other custom mechanical options are available – consult factory.
 **Many other winding options are available – consult factory.

Select your options below and place their code in its corresponding block as shown on page 5.

T TERMINATION **F** FEEDBACK OPTIONS **O** OTHER OPTIONS
 L – Leads (std) H – Hall Effect (std) G – Gearhead
 C – Connector
 M – MS connector

BN12 IP65 Typical Outline

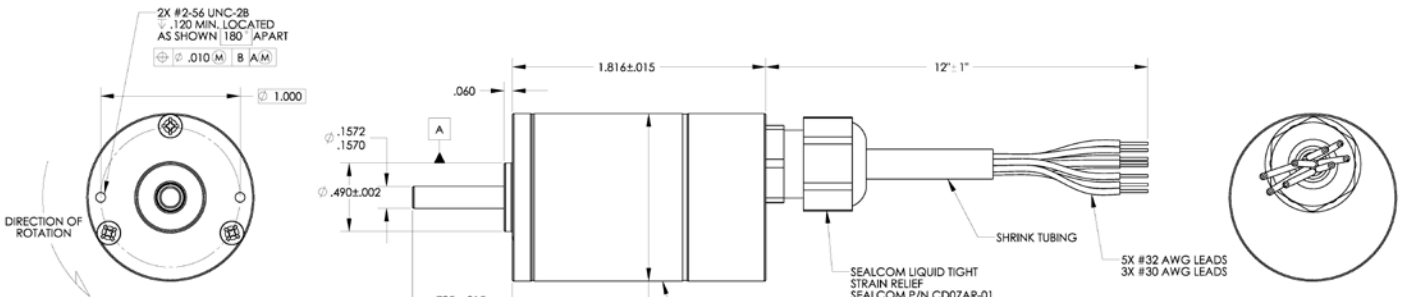

Termination Table

PIN COLOR	CONNECTION
YELLOW	V _{CC}
GRAY	GROUND
RED	A COIL
BLACK	B COIL
GREEN	C COIL
BLUE	S2 OUT
BROWN	S1 OUT
ORANGE	S3 OUT

Dimensions are in inches

BN12 IP65 Performance Curves

BN12 IP65 Performance Curves

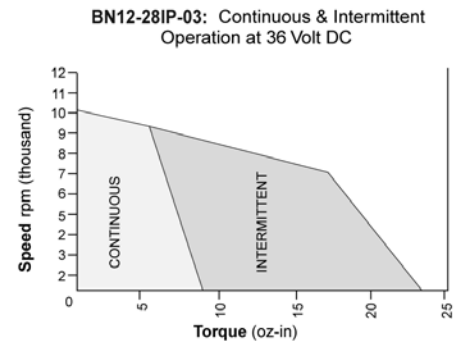
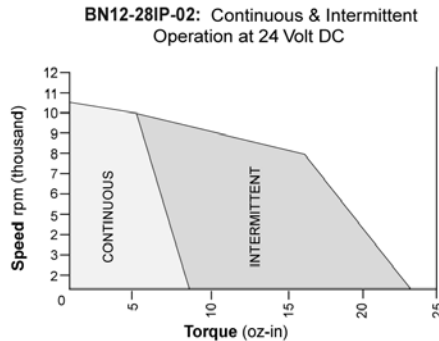
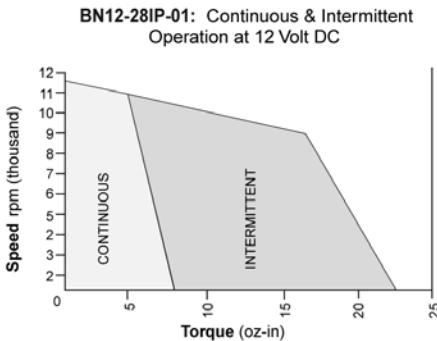
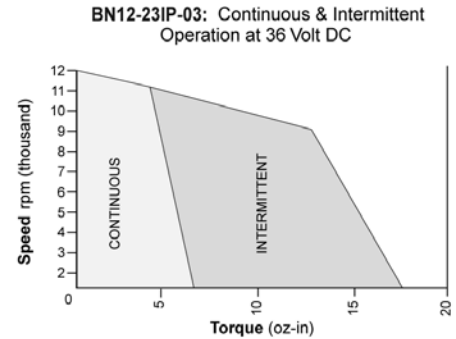
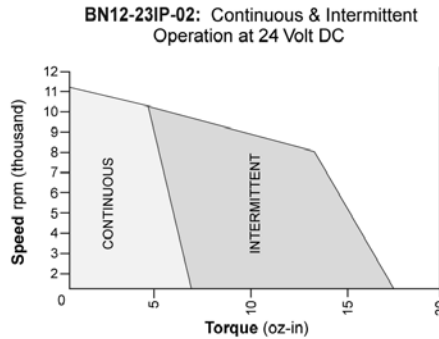
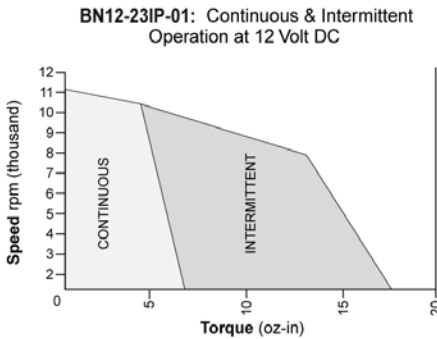
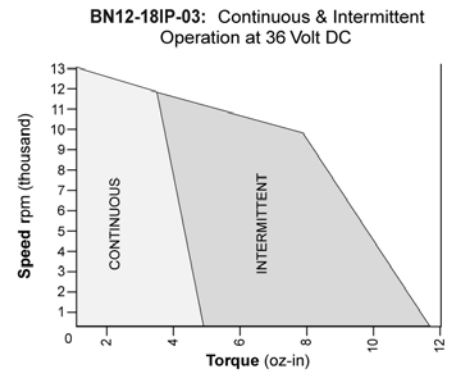
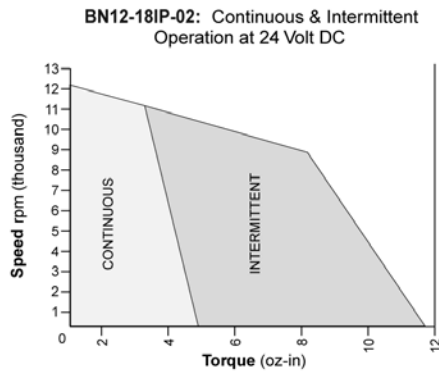
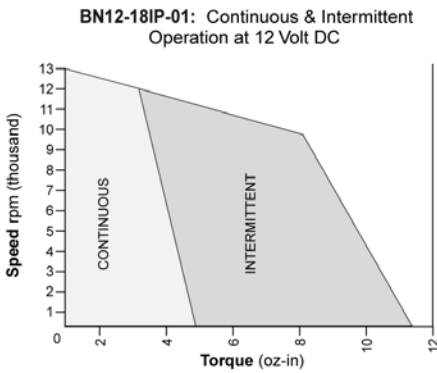
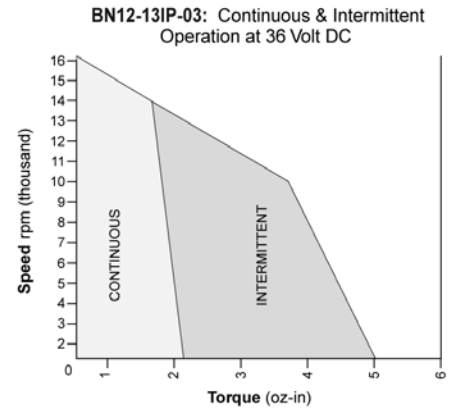
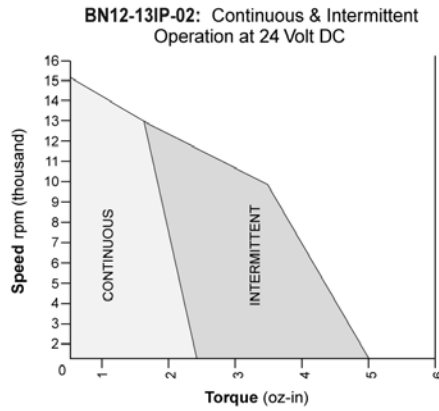
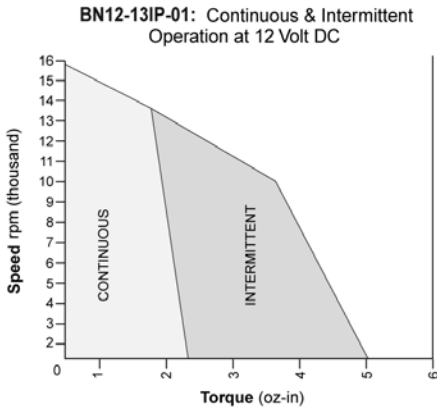

Note: Intermittent operation is based on a 20% duty cycle of one minute on, four minutes off.
Please contact the factory regarding the duty cycle of your application.