

TYPICAL APPLICATIONS

- Medical equipment - pumps, blowers and centrifuges
- Scanners
- Packaging equipment and printing products
- HVAC equipment (air handling)

FEATURES

- Inside rotor construction for quick acceleration
- 4 pole motors for high speed applications
- Compact size
- Continuous torque to 78.0 oz-in
- High energy neodymium magnets
- Safe, arcless operation
- High speed capability – up to 35,000 rpm
- High torque per dollar ratio

BENEFITS

- Operation at any single speed - not limited to AC frequency
- Motor life is not limited to brush or commutator life
- An essentially linear speed / torque curve
- Efficient operation without losses associated with brushes and commutation or armature induction
- Precise, variable speed control
- Extremely quiet operation
- Long-life operation

ENCODERS

High resolution, high reliability, and state-of-the-art technology in a small package:

- Bidirectional incremental code
- Up to 1024 cycles standard
- Up to 3 channels: A, B, and index
- TTL / CMOS compatible
- Hewlett Packard HEDS-5500 encoder standard, other configurations and resolutions available

SILENCER BRUSHLESS MOTOR DRIVES

Optimized for use with Silencer Brushless DC motors, these drives provide:

- Multiple operating modes - commutation, velocity, torque, 2 and 4 quadrant
- Feedback using Hall effect sensor or encoder
- Efficient PWM speed control
- CE approved for European applications
- Low cost
- Operating temperatures from -10° to 45°C

Note: This catalog contains basic marketing information and general part descriptions of Moog Components Group product lines. With respect to the U.S. export regulations, the products described herein are controlled by the U.S. Commerce Department or the U.S. State Department. Contact Moog Components Group for additional detail on the export controls that are applicable to your part.

Silencer® Series Brushless DC Motors

BN12, 23 and 34 High Speed



High Speed Brushless Motors

BN high speed brushless motors offer relatively high speeds in the same BN package size. Ideal for applications involving higher speeds at higher power levels, such as medical centrifuge, pumps and blowers. Utilizing high energy rare earth magnets, these motors provide excellent value in a high speed, high power motor.

Reliable, Low-Cost Operation

The compact BN motors are well-suited for applications demanding low audible noise and long life. An aluminum housing protects the unit in rugged applications and environments. Typical options include electronic drives, encoders and gearheads, as well as Hall effect, resolver and sensorless feedback.

For more information about how this product can be tailored to fit your specific application, contact our applications engineers.

BN12 High Speed Specifications

SPECIFICATION AND NUMBERING SYSTEM

Part Numbering System Guide

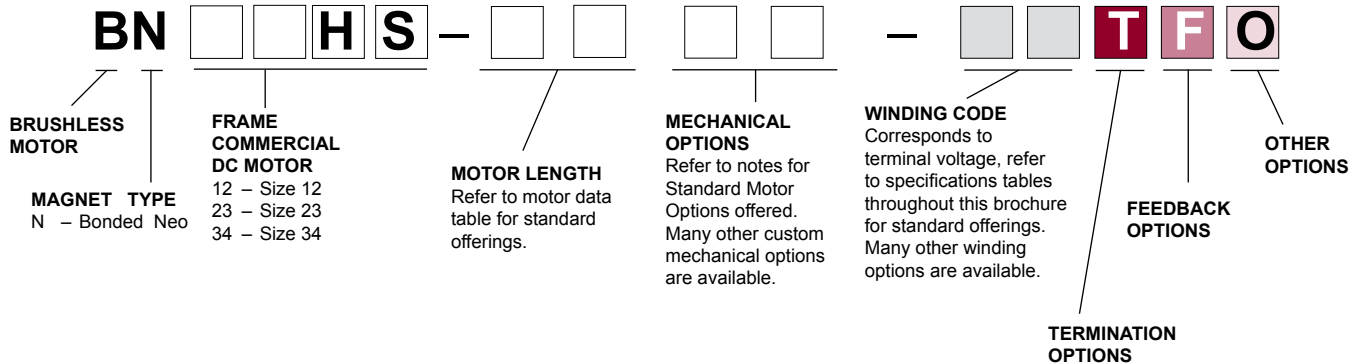

Inside Rotor
Brushless Motors

BN12HS SPECIFICATIONS - *Continuous Stall Torque 1.2 - 4.5 oz-in (0.0088 - 0.0318 Nm) Peak Torque 5 - 27 oz-in (0.0353 - 0.1907 Nm)*

Part Number*		BN12HS-13AF- <input type="checkbox"/> <input type="checkbox"/> <input type="checkbox"/> T F O			BN12HS-18AF- <input type="checkbox"/> <input type="checkbox"/> <input type="checkbox"/> T F O			BN12HS-23AF- <input type="checkbox"/> <input type="checkbox"/> <input type="checkbox"/> T F O			BN12HS-28AF- <input type="checkbox"/> <input type="checkbox"/> <input type="checkbox"/> T F O		
Winding Code**		01	02	03	01	02	03	01	02	03	01	02	03
L = Length	inches	1.30			1.80			2.30			2.80		
	millimeters	33.0			45.7			58.4			71.1		
Terminal Voltage	volts DC	12.0	24.0	36.0	12.0	24.0	36.0	12.0	24.0	36.0	12.0	24.0	36.0
Peak Torque	oz-in	5.0	5.0	5.0	11.0	11.0	12.0	18.0	20.0	20.0	27.0	27.0	27.0
	Nm	0.0353	0.0353	0.0353	0.0777	0.0777	0.0847	0.1271	0.1412	0.1412	0.1907	0.1907	0.1907
Continuous Stall Torque	oz-in	1.2	1.3	1.3	2.0	2.0	2.0	3.2	3.6	3.6	4.3	4.4	4.5
	Nm	0.0088	0.0092	0.0092	0.0141	0.0141	0.0141	0.0229	0.0254	0.0254	0.0304	0.0311	0.0318
Rated Speed	RPM	26000.00	35670.0	27570.0	23520.0	22800.0	24520.0	19650.0	20500.0	22740.0	20050.0	20270.0	18450.0
	rad/sec	2723	3735	2887	2463	2388	2568	2058	2147	2381	2100	2123	1932
Rated Torque	oz-in	1.2	1.2	1.2	2.0	2.0	2.0	3.0	3.3	3.3	3.9	4.0	4.2
	Nm	0.0085	0.0083	0.0083	0.0138	0.0141	0.0141	0.0212	0.0233	0.0233	0.0275	0.0282	0.0297
Rated Current	Amps	2.50	1.40	1.00	3.90	2.00	1.40	5.00	2.70	2.00	6.30	3.20	2.10
Rated Power	watts	21.00	22.0	24.00	34.0	34.0	37.0	44.0	50.0	55.0	58.0	60.0	57.0
Torque Sensitivity	oz-in/amp	0.44	0.89	1.27	0.51	1.05	1.50	0.62	1.25	1.72	0.64	1.28	2.07
	Nm/amp	0.0031	0.0063	0.0090	0.0036	0.0074	0.0106	0.0044	0.0088	0.0121	0.0045	0.0090	0.0146
Back EMF	volts/KRPM	0.32	0.66	0.94	0.38	0.78	1.11	0.46	0.92	1.27	0.48	0.95	1.53
	volts/rad/sec	0.0031	0.0063	0.0090	0.0036	0.0074	0.0106	0.0044	0.0088	0.0121	0.0045	0.0090	0.0146
Terminal Resistance	ohms	0.92	3.69	7.45	0.56	2.25	4.52	0.42	1.32	2.54	0.28	1.04	2.63
Terminal Inductance	mH	0.27	1.11	2.28	0.17	0.70	1.43	0.14	0.54	1.01	0.10	0.42	1.08
Motor Constant	oz-in/sq.rt.watt	0.46	0.46	0.47	0.68	0.70	0.71	0.96	1.09	1.08	1.21	1.26	1.28
	Nm/sq.rt.watt	0.00324	0.00327	0.00329	0.00481	0.00494	0.00498	0.00676	0.00768	0.00762	0.00854	0.00886	0.00901
Rotor Inertia	oz-in-sec ² x10 ⁻³	0.02	0.02	0.02	0.04	0.04	0.04	0.06	0.06	0.06	0.08	0.08	0.08
	g-cm ²	1.4	1.4	1.4	2.8	2.8	2.8	4.0	4.2	4.2	5.4	5.6	5.6
Weight	oz	5.0	5.0	5.0	6.0	6.0	6.0	7.0	7.0	7.0	9.0	9.0	9.0
	g	142.0	142.0	142.0	170.4	170.4	170.4	198.8	198.8	198.8	255.6	255.6	255.6
# of Poles		4.0	4.0	4.0	4.0	4.0	4.0	4.0	4.0	4.0	4.0	4.0	4.0
Timing		120°	120°	120°	120°	120°	120°	120°	120°	120°	120°	120°	120°
Mech. Time Constant	ms	13.5	13.2	13.1	12.2	11.6	11.4	8.8	7.2	7.3	7.4	7.2	6.9
Electrical Time Constant	ms	0.29	0.30	0.31	0.30	0.31	0.32	0.33	0.41	0.40	0.36	0.40	0.41
Thermal Resistivity	deg. C/watt	15.2	42.5	8.8	8.2	7.4	7.4	6.4	7.1	6.4	5.9	6.2	5.7
Speed/Torque Gradient	rpm/oz-in	6534.1	6281.9	6240.6	2889.6	2747.3	2714.7	1472.7	1147.8	1162.8	911.5	855.3	830.4

Notes:

- Motor mounted to a 4 x 4 x 1/4 inches aluminum plate, still air.
- Maximum winding temperature of 155°C.
- Typical electrical specifications at 25°C.
- Motor Terminal Voltages are representative only; motors may be operated at voltages other than those listed in the table. For assistance please contact an applications engineer.
- For MS (military style) connector, please specify connector housing and terminal.
- Data for informational purposes only. Should not be considered a binding performance agreement. For specific applications, please contact the factory.

*Many other custom mechanical options are available – consult factory.

**Many other winding options are available – consult factory.

Select your options below and place their code in its corresponding block as shown above.

- | | | |
|---|--|---|
| <input type="checkbox"/> TERMINATION | <input type="checkbox"/> FEEDBACK OPTIONS | <input type="checkbox"/> OTHER OPTIONS |
| L – Leads (std) | H – Hall Effect (std) | D – Drive |
| C – Connector | R – Resolver | E – Encoder |
| M – MS Connector | S – Sensorless | G – Gearhead |

BN12 High Speed Performance Curves

BN12 Performance Curves

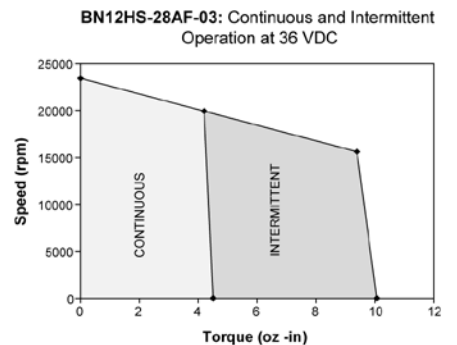
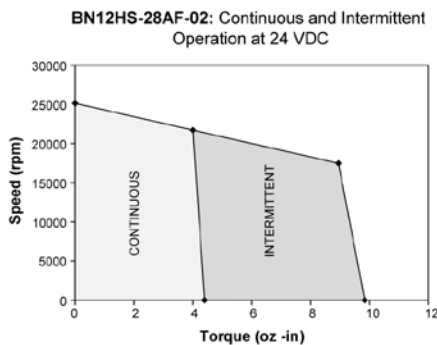
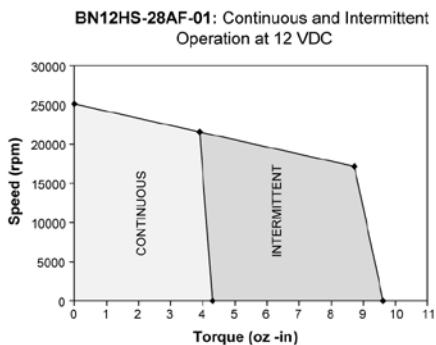
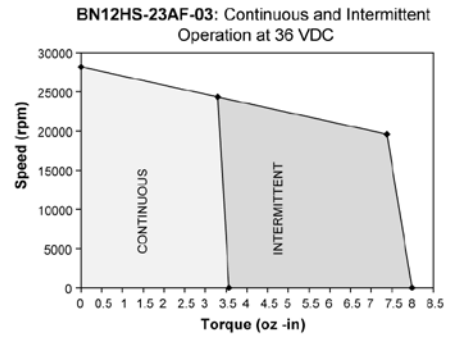
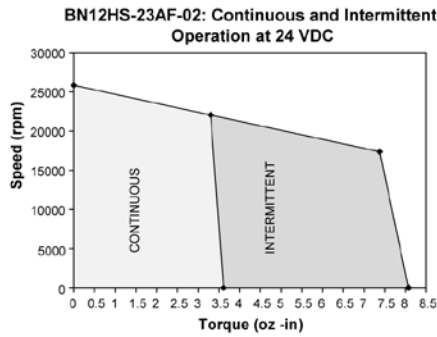
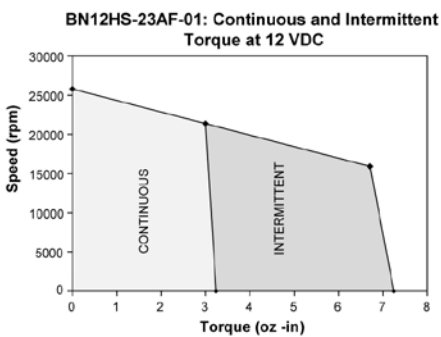
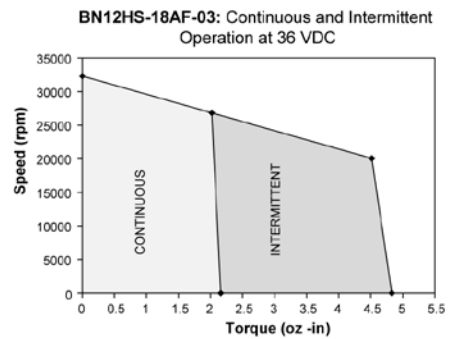
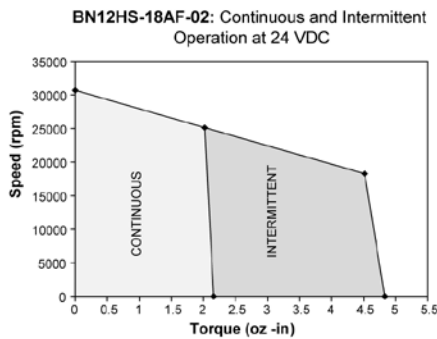
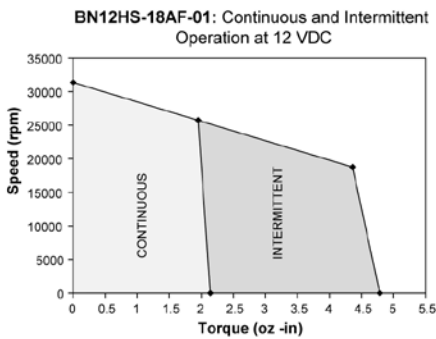
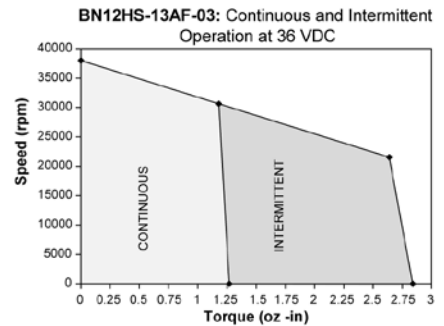
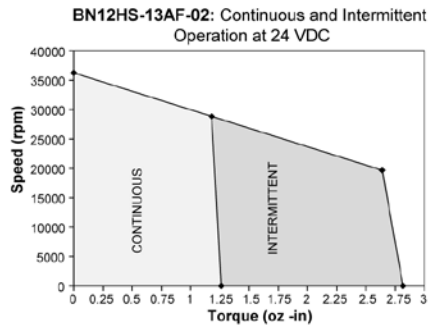
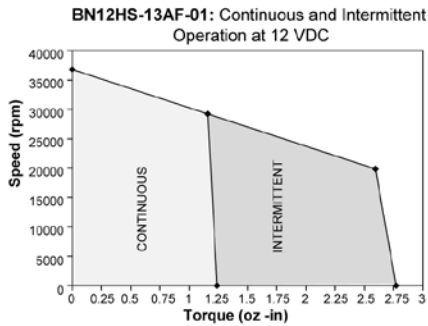

Note: Intermittent operation is based on a 20% duty cycle of one minute on, four minutes off. Please contact the factory regarding the duty cycle of your application.

BN23 High Speed Specifications

Typical Outline Drawing - BN12

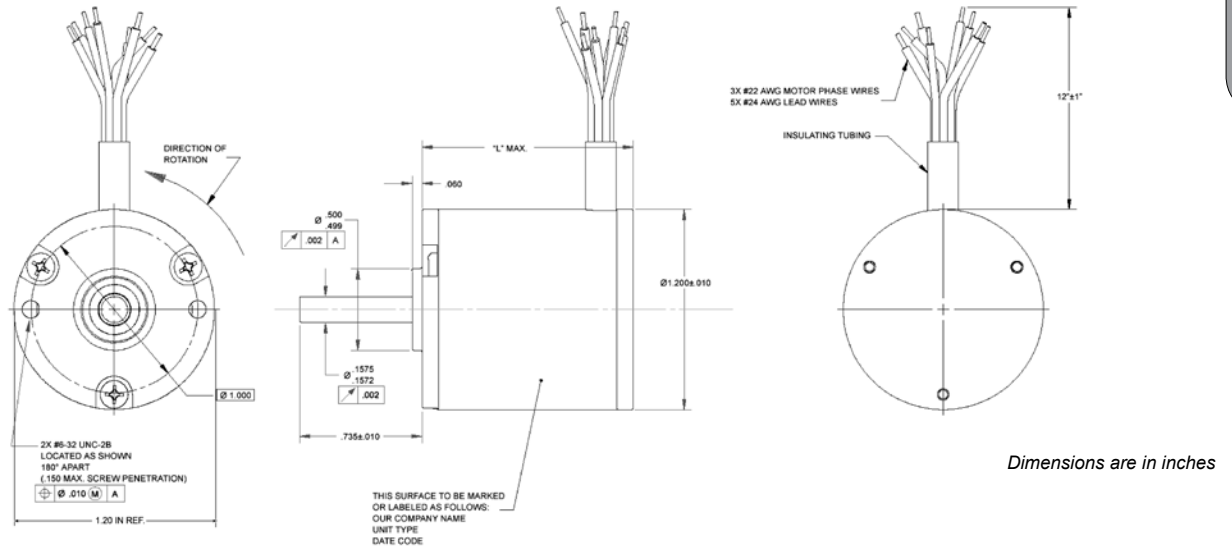

Inside Rotor
Brushless Motors

BN23HS SPECIFICATIONS - Continuous Stall Torque 6 - 32 oz-in (0.042 - 0.226 Nm) Peak Torque 41 - 222 oz-in (0.2895 - 1.5677 Nm)

Part Number*	BN23HS-13HS- <input type="checkbox"/> <input type="checkbox"/> <input type="checkbox"/> T F <input type="checkbox"/>			BN23HS-18HS- <input type="checkbox"/> <input type="checkbox"/> <input type="checkbox"/> T F <input type="checkbox"/>			BN23HS-23HS- <input type="checkbox"/> <input type="checkbox"/> <input type="checkbox"/> T F <input type="checkbox"/>			BN23HS-28HS- <input type="checkbox"/> <input type="checkbox"/> <input type="checkbox"/> T F <input type="checkbox"/>			
	01	02	03	01	02	03	01	02	03	01	02	03	
Winding Code**	01	02	03	01	02	03	01	02	03	01	02	03	
L = Length	inches	1.41			1.91			2.41			2.91		
	millimeters	35.8			48.5			61.2			73.9		
Terminal Voltage	volts DC	24	36	48	24	36	48	24	36	48	24	36	48
Peak Torque	oz-in	41	41	41	101	101	101	162	162	162	222	222	222
	Nm	0.2895	0.2895	0.2895	0.7132	0.7132	0.7132	1.1440	1.1440	1.1440	1.5677	1.5677	1.5677
Continuous Stall Torque	oz-in	6	6	6	16	16	16	23	25	24	27	32	32
	Nm	0.042	0.042	0.042	0.113	0.113	0.113	0.162	0.177	0.169	0.191	0.226	0.226
Rated Speed	RPM	18991	19048	19531	19644	19818	19225	14702	14875	14908	13285	14917	14629
	rad/sec	1989	1995	2045	2057	2075	2013	1540	1558	1561	1391	1562	1532
Rated Torque	oz-in	3.5	3.5	3.5	8.0	8.0	8.0	16.0	16.0	16.0	21.0	21.0	21.0
	Nm	0.025	0.025	0.025	0.056	0.056	0.056	0.113	0.113	0.113	0.148	0.148	0.148
Rated Current	Amps	2.7	1.8	1.4	5.8	3.9	2.9	8.3	5.6	4.2	9.9	7.3	5.3
Rated Power	watts	49	49	51	116	117	114	174	176	176	206	232	227
Torque Sensitivity	oz-in/amp	1.54	2.31	3.03	1.56	2.34	3.13	2.06	3.09	4.12	2.25	3.10	4.22
	Nm/amp	0.0109	0.0163	0.0214	0.0110	0.0165	0.0221	0.0145	0.0218	0.0291	0.0159	0.0219	0.0298
Back EMF	volts/KRPM	1.14	1.71	2.24	1.15	1.73	2.31	1.52	2.28	3.04	1.66	2.29	3.12
	volts/rad/sec	0.011	0.016	0.021	0.011	0.017	0.022	0.015	0.022	0.029	0.016	0.022	0.030
Terminal Resistance	ohms	0.70	1.65	2.72	0.14	0.30	0.50	0.14	0.28	0.51	0.14	0.19	0.35
Terminal Inductance	mH	0.48	1.08	1.86	0.23	0.52	0.93	0.26	0.59	1.04	0.23	0.44	0.81
Motor Constant	oz-in/sq.rt.watt	1.84	1.80	1.84	4.17	4.27	4.43	5.51	5.84	5.77	6.01	7.11	7.13
	Nm/sq.rt.watt	0.13	0.13	0.013	0.029	0.030	0.031	0.039	0.041	0.041	0.042	0.050	0.050
Rotor Inertia	oz-in-sec ² x10 ⁻³	0.51	0.51	0.51	0.99	0.99	0.99	1.50	1.50	1.50	1.90	1.90	1.90
	g-cm ²	36.0	36.0	36.0	69.9	69.9	69.9	105.9	105.9	105.9	134.1	134.1	134.1
Weight	oz	10.0	10.0	10.0	15.0	15.0	15.0	21.0	21.0	21.0	26.0	26.0	26.0
	g	284.0	284.0	284.0	426.0	426.0	426.0	596.4	596.4	596.4	738.4	738.4	738.4
# of Poles		4.0	4.0	4.0	4.0	4.0	4.0	4.0	4.0	4.0	4.0	4.0	4.0
Timing		120°	120°	120°	120°	120°	120°	120°	120°	120°	120°	120°	120°
Mech. Time Constant	ms	21.3	22.3	21.4	8.1	7.7	7.2	7.0	6.2	6.4	7.4	5.3	5.3
Electrical Time Constant	ms	0.69	0.65	0.68	1.64	1.73	1.86	1.86	2.11	2.04	1.64	2.32	2.31
Thermal Resistivity	deg. C/watt	6.7	6.8	6.3	4.6	4.5	4.1	4.2	4.1	4.2	3.4	3.4	3.9
Speed/Torque Gradient	rpm/oz-in	398.7	417.7	400.8	78.0	74.1	69.2	44.7	39.7	40.7	37.5	26.8	26.6

Notes:

- Motor mounted to a 4 x 4 x 1/4 inches aluminum plate, still air.
- Maximum winding temperature of 155°C.
- Typical electrical specifications at 25°C.
- Motor Terminal Voltages are representative only; motors may be operated at voltages other than those listed in the table. For assistance please contact an applications engineer.
- For MS (military style) connector, please specify connector housing and terminal.
- Data for informational purposes only. Should not be considered a binding performance agreement. For specific applications, please contact the factory.

*Many other custom mechanical options are available – consult factory.

**Many other winding options are available – consult factory.

Select your options below and place their code in its corresponding block as shown on page 49.

- | | | |
|---|--|---|
| <input type="checkbox"/> TERMINATION | <input type="checkbox"/> FEEDBACK OPTIONS | <input type="checkbox"/> OTHER OPTIONS |
| L – Leads (std) | H – Hall Effect (std) | D – Drive |
| C – Connector | R – Resolver | E – Encoder |
| M – MS Connector | S – Sensorless | G – Gearhead |

BN23 High Speed Performance Curves

Inside Rotor
Brushless Motors

BN23 Performance Curves

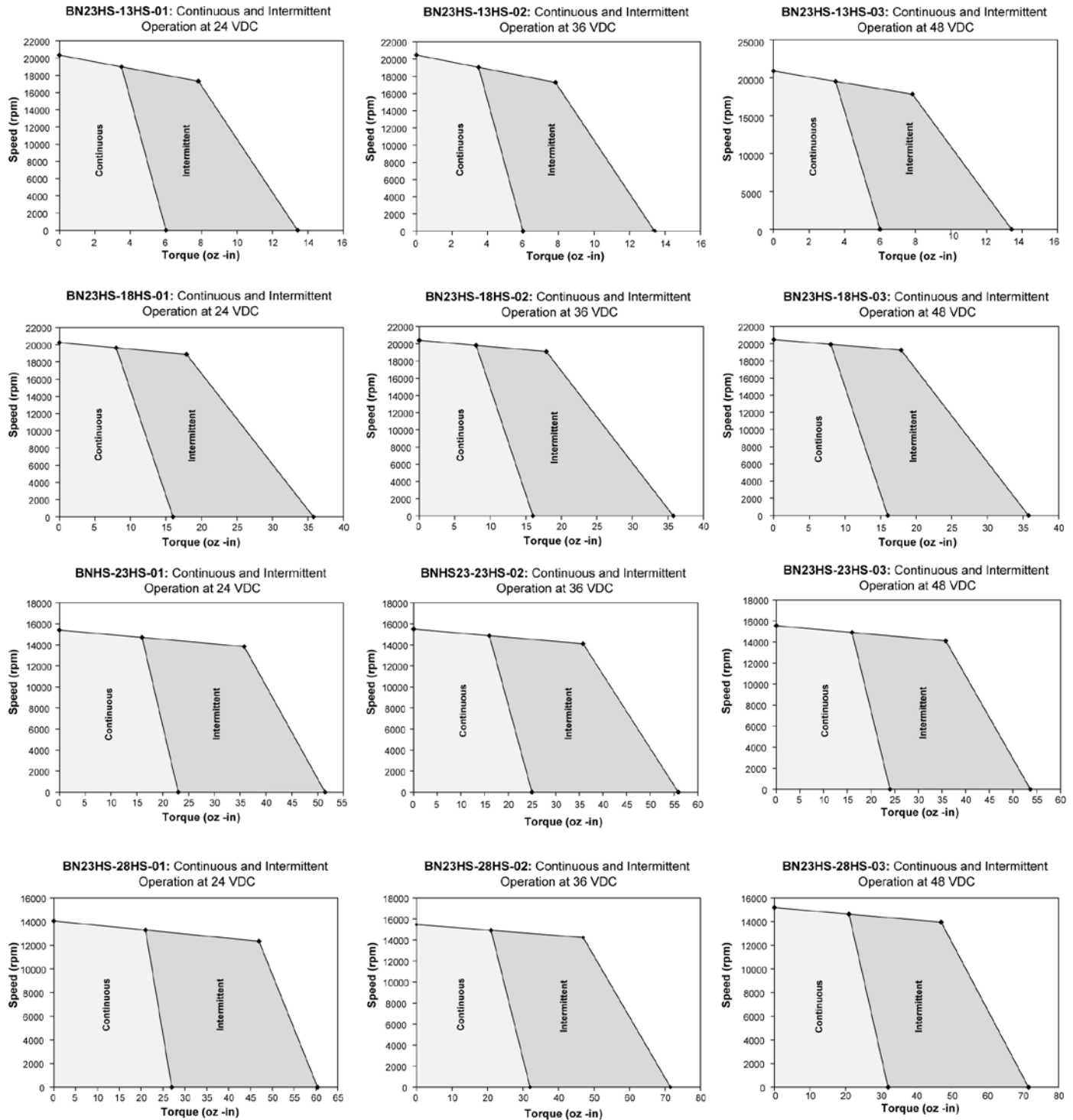

Note: Intermittent region based upon 20% duty cycle - 1 minute on, 4 minutes off.

BN23 High Speed Outline

Typical Outline Drawing - BN23

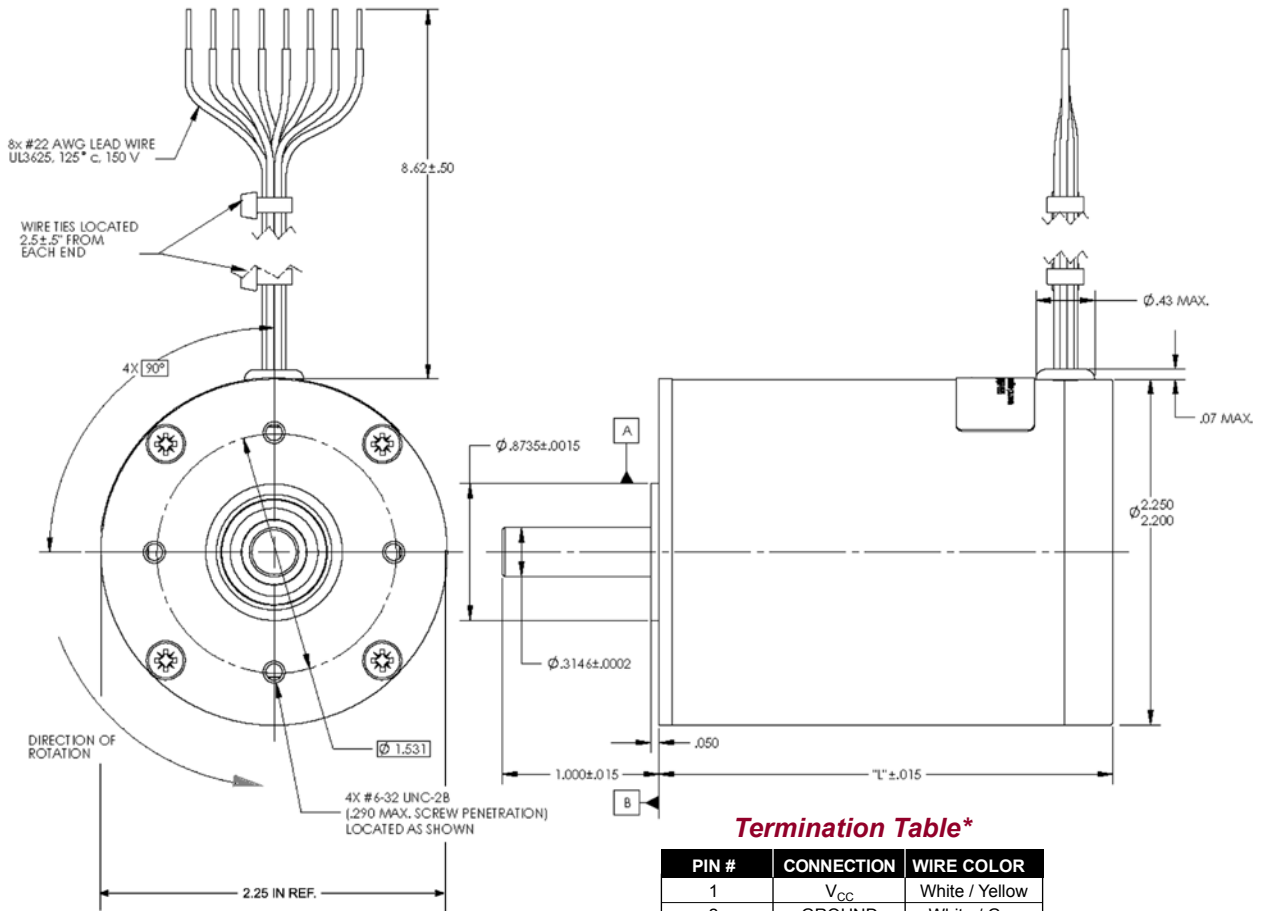

Termination Table*

PIN #	CONNECTION	WIRE COLOR
1	V _{CC}	White / Yellow
2	GROUND	White / Gray
3	A COIL	White / Violet
4	B COIL	White / Black
5	C COIL	Green
6	S2 OUT	White / Blue
7	S1 OUT	White / Brown
8	S3 OUT	White

Dimensions are in inches

*We reserve the right to use solid color wires or white wires with color trace.

Timing Diagram (4 Pole) CCW Rotation

DEGREES	ELEC															
	0	60	120	180	240	300	360	60	120	180	240	300	360			
	MECH															
	0	30	60	90	120	150	180	210	240	270	300	330	360			
S1 OUT																
S2 OUT																
S3 OUT																
A COIL	-	0	+	+	0	-	-	0	+	+	0	-				
B COIL	+	+	0	-	-	0	+	+	0	-	-	0				
C COIL	0	-	-	0	+	+	0	-	-	0	+	+				

BN34 High Speed Specifications

Inside Rotor
Brushless Motors

BN34HS SPECIFICATIONS -

Continuous Stall Torque 48 - 99 oz-in (0.3390 - 0.6991 Nm)
Peak Torque 177 - 363 oz-in (1.2499 - 2.5633 Nm)

Part Number*		BN34HS-25AF- <input type="checkbox"/> <input type="checkbox"/> <input checked="" type="checkbox"/> <input type="checkbox"/> <input type="checkbox"/>			BN34HS-35AF- <input type="checkbox"/> <input type="checkbox"/> <input checked="" type="checkbox"/> <input type="checkbox"/> <input type="checkbox"/>		
Winding Code**		01	02	03	01	02	03
L = Length	inches	2.50			3.50		
	millimeters	63.5			88.9		
Terminal Voltage	volts DC	24.0	50.0	100.0	24.0	50.0	100.0
Peak Torque	oz-in	177.0	177.0	177.0	363.0	363.0	363.0
	Nm	1.2499	1.2499	1.2499	2.5633	2.5633	2.5633
Continuous Stall Torque	oz-in	48.0	49.0	48.0	91.0	98.0	99.0
	Nm	0.3390	0.3460	0.3390	0.6426	0.6920	0.6991
Rated Speed	RPM	14011.0	13900.0	14640.0	7100.0	9340.0	9400.0
	rad/sec	1467	1456	1533	744	978	984
Rated Torque	oz-in	34.0	34.0	34.0	78.0	78.0	78.0
	Nm	0.2401	0.2401	0.2401	0.5508	0.5508	0.5508
Rated Current	Amps	18.60	8.60	4.50	22.40	13.00	6.50
Rated Power	watts	396.0	381.0	397.0	478.0	591.0	591.0
Torque Sensitivity	oz-in/amp	1.94	4.20	8.08	3.59	6.21	12.42
	Nm/amp	0.0137	0.0297	0.0571	0.0254	0.0439	0.0877
Back EMF	volts/KRPM	1.43	3.10	5.97	2.66	4.59	9.18
	volts/rad/sec	0.0137	0.0297	0.0571	0.0254	0.0439	0.0877
Terminal Resistance	ohms	0.054	0.242	0.920	0.063	0.163	0.638
Terminal Inductance	mH	0.18	0.85	3.14	0.33	0.99	3.95
Motor Constant	oz-in/sq.rt.watts	8.35	8.54	8.42	14.30	15.38	15.55
	Nm/sq.rt.watts	0.05895	0.06029	0.05949	0.10100	0.10862	0.10980
Rotor Inertia	oz-in-sec ² x10 ⁻³	7.30	7.30	7.30	14.00	14.00	14.00
	g-cm ²	515.2	515.2	515.2	988.0	988.0	988.0
Weight	oz	38.0	38.0	38.0	65.0	66.0	66.0
	g	1079.2	1079.2	1079.2	1846.0	1874.4	1874.4
# of Poles		4.0	4.0	4.0	4.0	4.0	4.0
Timing		120°	120°	120°	120°	120°	120°
Mech. Time Constant	ms	14.8	14.2	14.6	9.7	8.4	8.2
Electrical Time Constant	ms	3.33	3.51	3.41	5.24	6.07	6.19
Thermal Resistivity	deg. C/watt	1.1	1.3	1.3	0.8	0.9	1.0
Speed/Torque Gradient	rpm/oz-in	58.5	55.8	57.3	19.8	17.1	16.8

Notes:

- Motor mounted to a 4 x 4 x 1/4 inches aluminum plate, still air.
- Maximum winding temperature of 155°C.
- Typical electrical specifications at 25°C.
- Motor Terminal Voltages are representative only; motors may be operated at voltages other than those listed in the table. For assistance please contact an applications engineer.
- For MS (military style) connector, please specify connector housing and terminal.
- Data for informational purposes only. Should not be considered a binding performance agreement. For specific applications, please contact the factory.

*Many other custom mechanical options are available – consult factory.

**Many other winding options are available – consult factory.

Select your options below and place their code in its corresponding block as shown on page 49.

- | | | |
|--|---|---|
| <input checked="" type="checkbox"/> TERMINATION | <input checked="" type="checkbox"/> FEEDBACK OPTIONS | <input type="checkbox"/> OTHER OPTIONS |
| L – Leads (std) | H – Hall Effect (std) | D – Drive |
| C – Connector | R – Resolver | E – Encoder |
| M – MS Connector | S – Sensorless | G – Gearhead |

Timing Diagram (4 Pole) CCW Rotation

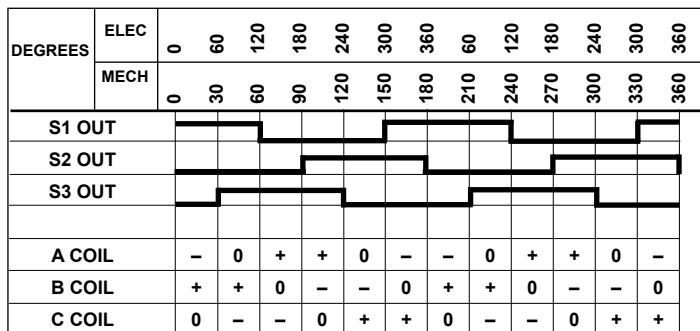

BN34 High Speed Performance Curves

Typical Outline Drawing - BN34

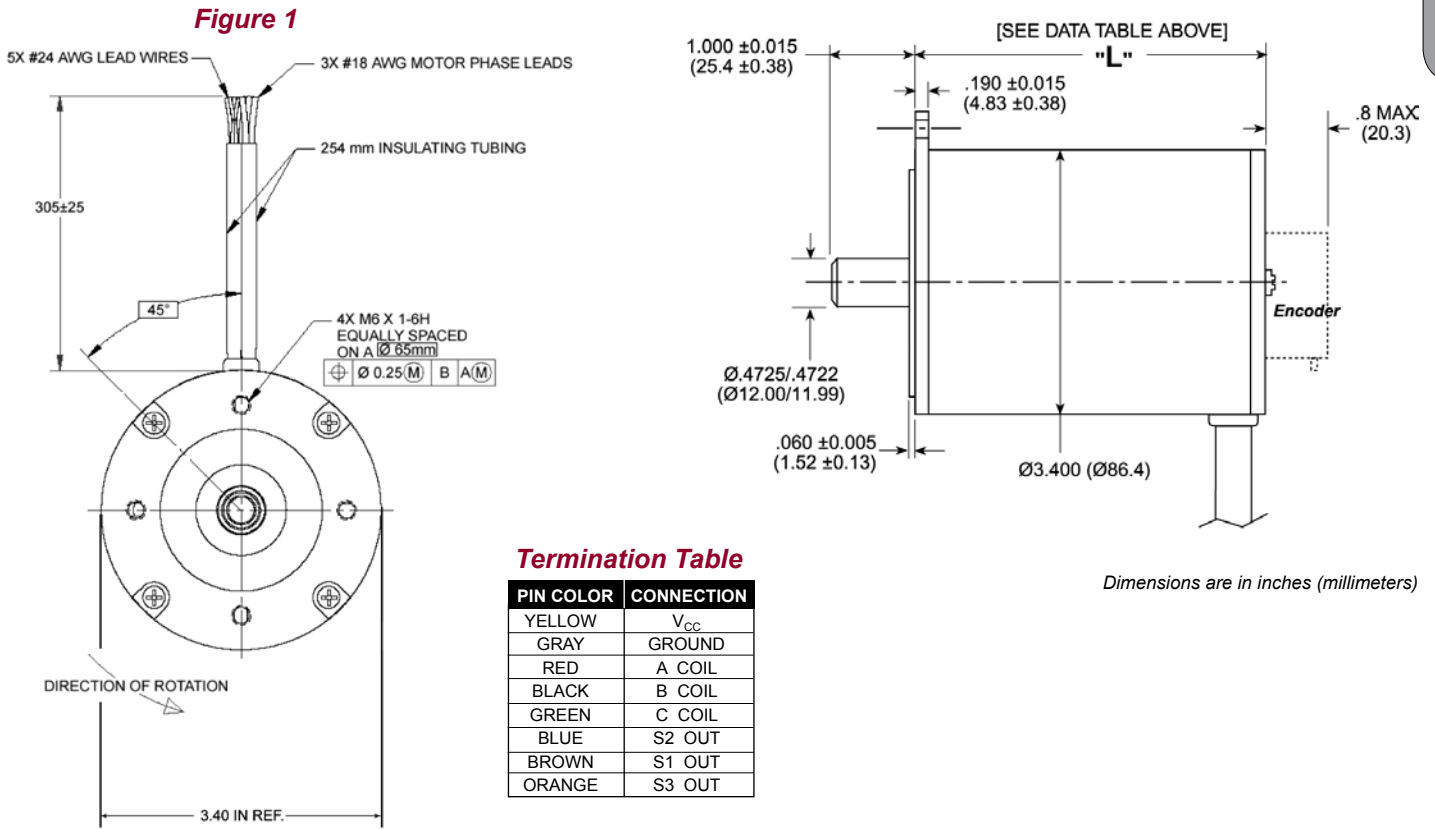

Note: Square or Round Cap Available: AF (standard version) comes standard with square cap, see drawing on page 30. For round cap version, see Figure 1 above.

BN34 Performance Curves

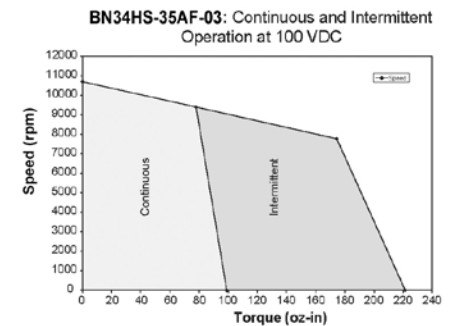
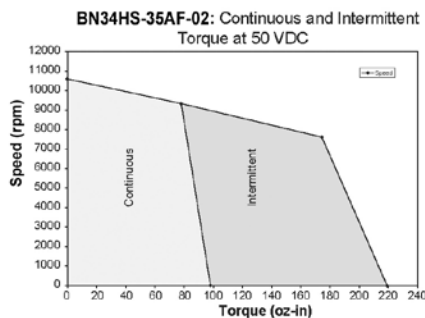
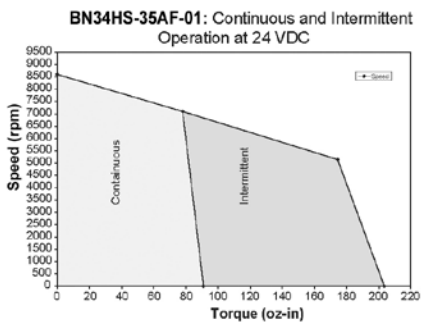
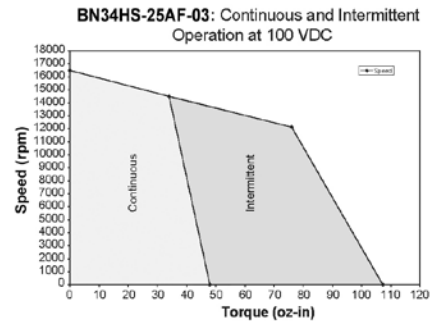
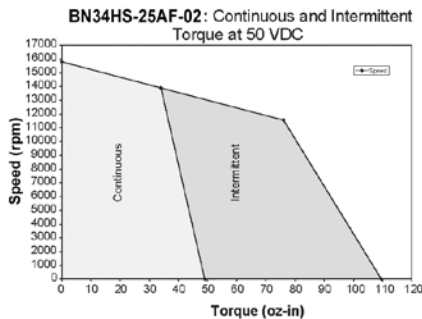
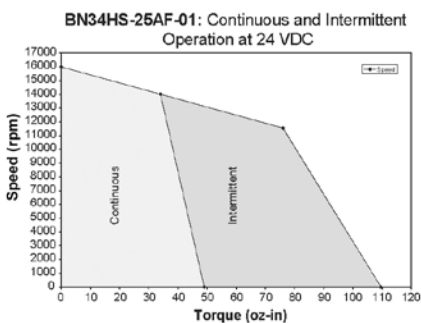

Note: Intermittent region based upon 20% duty cycle - 1 minute on, 4 minutes off.