

MOOG

D631 Series Servo Control Valves ISO 4401 Size 05

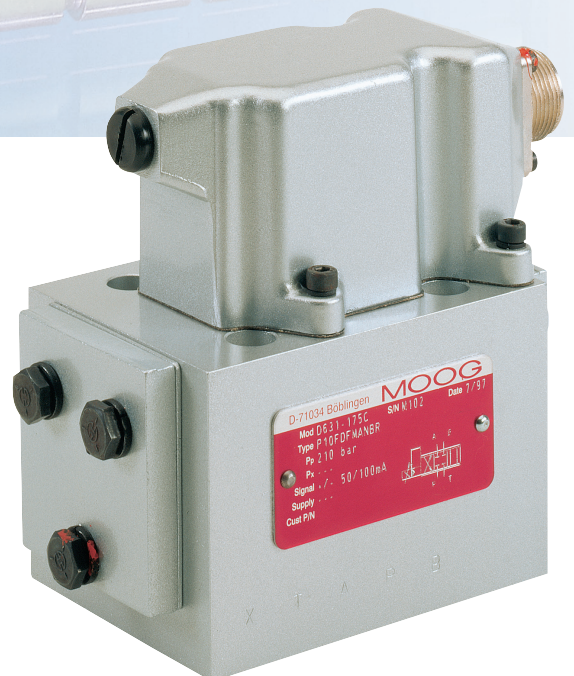
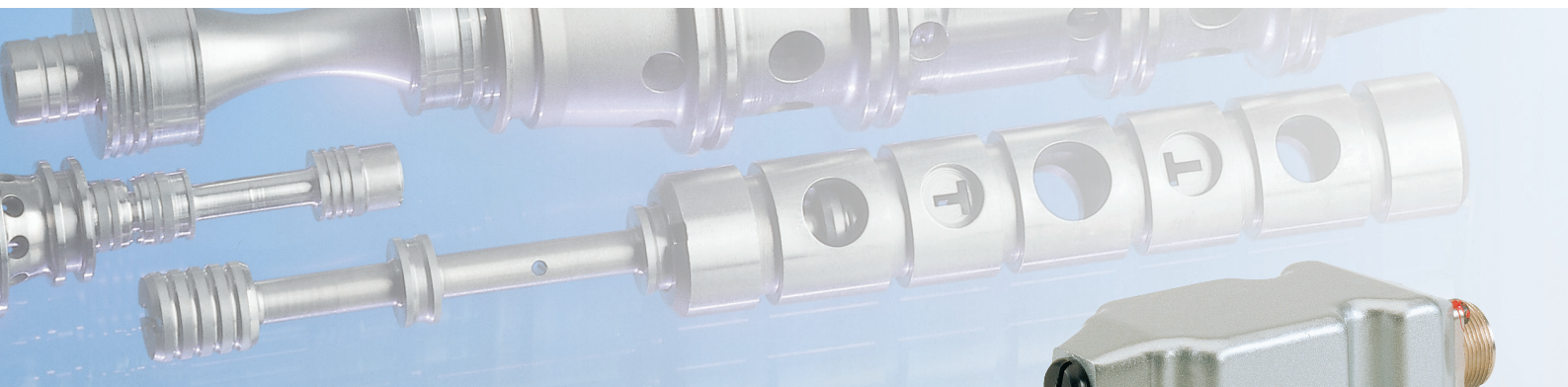

SECTION	PAGE	MOOG SERVO- AND PROPORTIONAL CONTROL VALVES
General	2	<p>For over 50 years Moog has manufactured proportional control valves with integrated electronics. During this time more than 200,000 valves have been delivered. These servo control valves have been proven to provide reliable control including injection and blow molding equipment, die casting machines, presses, heavy industry equipment, paper and lumber processing and other applications.</p> <p>D631 SERIES SERVO VALVE</p> <p>The servo control valves D631 Series are throttle valves for 3- and preferably 4-way applications. According to the requirements of the application, the user can select either the standard version (P) or the high response version (H). The main features of the high response valves are short stroke related improved dynamics and a more precise axis null cut.</p>
Benefits and Function	3	
General technical dates, Symbols	4	
Electrical Connection	5	
Technical Data	7	
Ordering Information	11	

DESCRIPTION

The proportional valves D631 Series consist of an electromechanical transformer (torque motor), a hydraulic amplifier (nozzle/flapper principle), a spool in a bushing and a cantilever feedback spring. The torque motor contains coils, pole pieces, permanent magnets and an armature. The armature is connected to a flexible tube which allows a limited rotation of the armature and at the same time seals the electromagnetic components against the hydraulic fluid.

The hydraulic amplifier is a full bridge arrangement with two upstream fixed orifices and two downstream variable orifices

created by two nozzles and a flapper between them. The flapper is connected at its upper end to the centre of the armature and extends downward through the flexure tube to the nozzles. A deflection of the flapper between the nozzles changes the size of the variable orifices in opposite sense.

The 4-way spool controls fluid flow from pressure port to one of the load ports and also from the other load port to return. Deflection of the feedback spring due to spool displacement produces a torque which is fed back to the torquemotor.



Valves available with intrinsically protection to EN 50.020 class EEx ia IIc T6. Special data sheet on request.

NOTICE

- Before installation of the valve into the system the complete hydraulic system must be flushed.

Our quality management system conforms to DIN EN ISO 9001.

BENEFITS OF SERVO VALVES

Operational features

- 2-stage version with dry torque motor
- Low friction double nozzle pilot stage
- High spool control forces
- Mechanical feedback
- Protection filter easy to replace

SERVO CONTROL VALVE OPERATING PRINCIPLE

An electrical current (command or input signal) is applied to the coils of the torquemotor and produces depending on the current polarity a clockwise or counter clockwise torque to the armature. The thereby deflected nozzle flapper system creates a pressure difference across the drive areas of the spool and effects its movement. The feedback spring connected to the armature engages with its lower end into a bore of the spool and is thus deflected by spool displacement. The motion of the spool stops when feedback torque and electromagnetic torque are in equilibrium. Then the flapper is again in hydraulic centre position (approximately). Thus the position of the spool is proportional to the electrical command signal.

D631 Series
two stage servo control valves

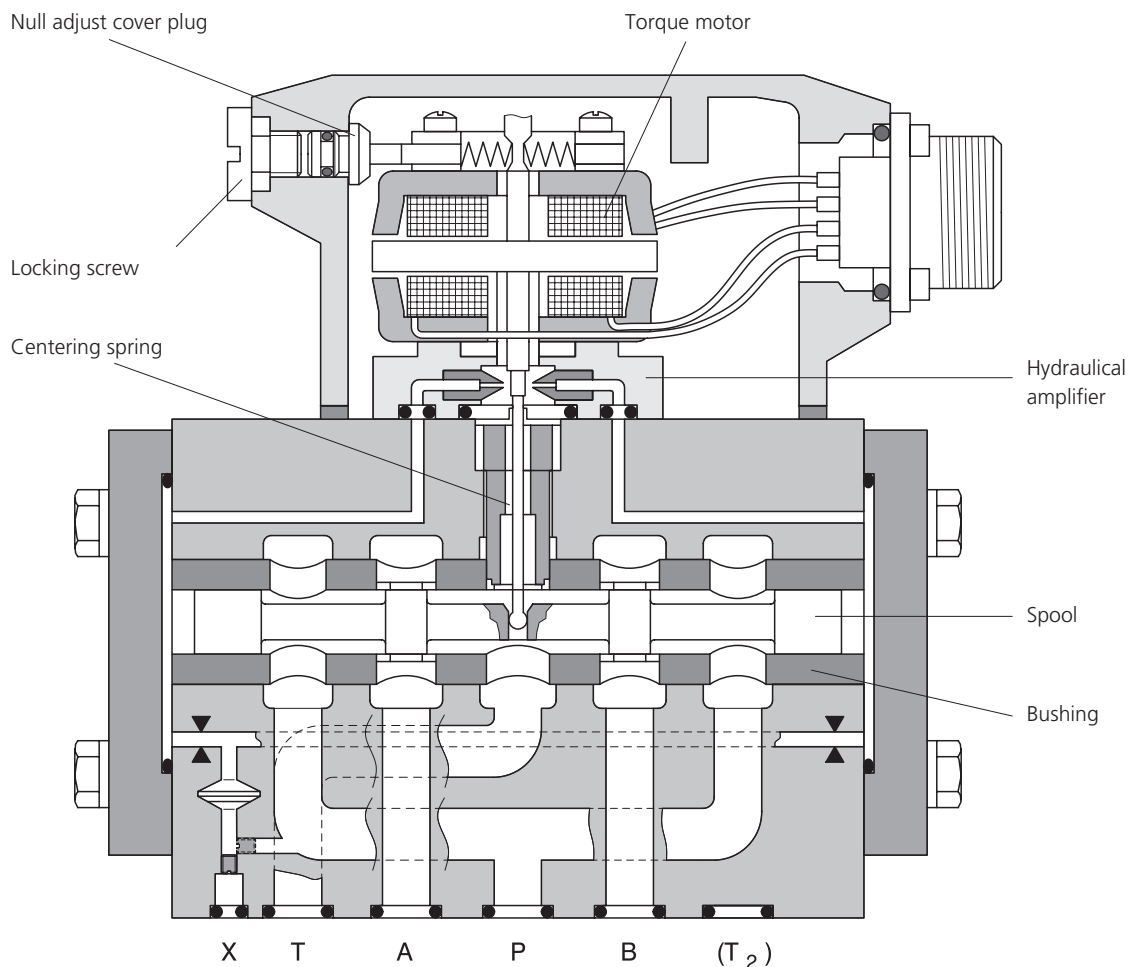
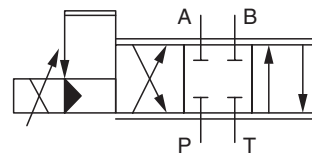

PERFORMANCE SPECIFICATIONS FOR STANDARD MODELS

Operating pressure range

Main stage:
ports P, A and B up to 315 bar (4500 psi)
port T 20% of pilot pressure,
max. 100 bar (1450 psi)

Pilot stage: regular version 15 to 210 bar
(200 to 3000 psi)
with dropping orifice 25 to 315 bar
(350 to 4500 psi)

Temperature range

Ambient -20 °C to +80 °C
(-4 °F to +170 °F)

Fluid -20 °C to +80 °C
(-4 °F to +170 °F)

Seal material NBR, FPM,
others on request

Operating fluid Mineral oil based hydraulic
fluid (DIN 51524, part 1 to
3), other fluids on request

Viscosity, recommended 15 to 100 mm²/s (cSt)

System filtration

High pressure filter (without bypass, but with dirt alarm) mounted in the main flow and if possible directly upstream of the valve.

Class of cleanliness

The cleanliness of the hydraulic fluid greatly effects the performance (spool positioning, high resolution) and wear (metering edges, pressure gain, leakage) of the valve.

Recommended cleanliness class

for normal operation: ISO 4406:1999 < 19/16 /13

for longer life: ISO 4406:1999 < 17/14 /11

Filter rating recommended

for normal operation: $\beta_{15} \geq 75$ (15 μm absolute)

for longer life: $\beta_{10} \geq 75$ (10 μm absolute)

Installation options

any position,
fixed or movable

Vibration 30 g (0.7 lbs), 3 axes

Mass 2.2 kg (4.9 lbs)

Degree of protection EN 60529: class IP 65, with
mating connector mounted

Shipping plate Delivered with an oil sealed
shipping plate

4-WAY FUNCTION

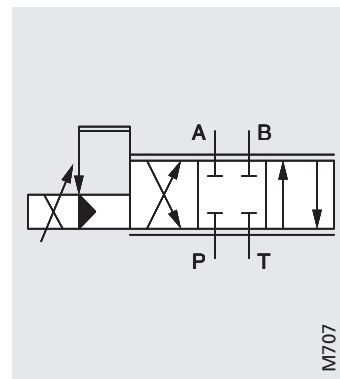

4-way version
optional X external

- Flow control (throttle valve) in port A and port B
- For 3-way function close port A or port B of the manifold
- Spools with exact axis cut, 1.5 to 3% or 10% overlap available

VALVE FLOW CALCULATIONS

The actual flow depends on the electrical command signal and the valve pressure drop, and may be calculated using the square root function for a sharp-edged orifice.

$$Q = Q_N \cdot \sqrt{\frac{\Delta p}{\Delta p_N}}$$

- Q / l/min = calculated flow
- Q_N / l/min = rated flow
- Δp / bar = actual valve pressure drop
- Δp_N / bar = rated valve pressure drop

If large flow rates with high valve pressure drops are required, an appropriate higher pilot pressure has to be chosen to overcome the flow forces. An approximate value can be calculated as follows:

$$p_x \geq 2,5 \cdot 10^{-2} \cdot \frac{Q}{A_K} \cdot \sqrt{\Delta p}$$

- Q / l/min = max. flow
- Δp / bar = valve pressure drop with Q
- A_K / cm² = spool drive area
- p_x / bar = pilot pressure

The pilot pressure p_x has to be at least 15 bar (200 psi), with throttle valve 25 bar (350 psi) above the return pressure of the pilot stage.

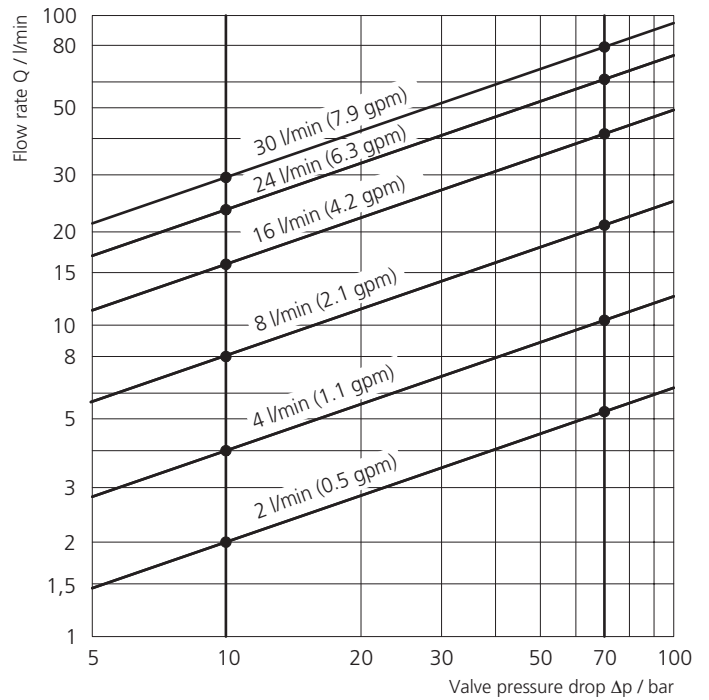

ELECTRICAL CONNECTION WITH 4-POLE CONNECTOR TO MIL C5015/145-2

The torque motor has 2 coils. The leads of the coils are single connected to the pins. For operation in parallel, series or single coil mode the corresponding wiring must be done in the mating connector.

Optional two types of coils are available:

Coil R with 28 Ω per coil

Coil Q with 300 Ω per coil

Connector Mil C5015/145-2	Parallel wiring		Series wiring		Single coils	
Coil type	R	Q	R	Q	R	Q
Input resistance (at 25°C) ¹⁾ / Ω	14	150	56	600	28	300
Rated current / mA	± 100	± 30	± 50	± 15	± 100	± 30
Inductance (at 60 Hz) / H	0.2	1.8	0.8	7.0	0.25	2.0
Electrical power / W	0.14	0.14	0.14	0.14	0.28	0.27
Connections for valve opening P *B, A *T	A and C (+) B and D (-)		A (+), D (-) B and C connected		A (+), B (-) or C (+), D (-)	

ELECTRICAL CONNECTION WITH CONNECTOR TO DIN 43650

The torque motor has 2 coils. The coils are connected in parallel inside the valve.

Two types of coils are available:

Coil R with 28 Ω

Coil Q with 300 Ω

Connector DIN 43650	Parallel wiring	
Coil type	R	Q
Input resistance (at 25°C) ¹⁾ / Ω	14	150
Rated current / mA	± 100	± 30
Inductance (at 60 Hz) / H	0.2	1.8
Electrical power / W	0.14	0.14
Connections for valve opening P *B, A *T	1 (+) and 3 (-)	

¹⁾ 65 °F

PERFORMANCE SPECIFICATIONS FOR STANDARD MODELS

Model ... Type			D631-... P..	D631-... H...
Mounting pattern			ISO 4401-05-05-0-94	
Valve body version			4-way, 2-stage with bushing-spool assembly	
Pilot stage	Nozzle / flapper		Standard	Highresponse
Pilot connection	optional, internal or external		X	X
Rated flow ($\pm 10\%$)	at $\Delta p_N = 5$ bar per land	l/min	2 / 4 / 8 / 16 / 24 / 30	
	at $\Delta p_N = 73$ psi per land	gpm	0.5 / 1.1 / 2.1 / 4.2 / 6.3 / 7.9	
Response time ¹⁾		ms	25	13
Threshold ¹⁾		%	< 1	< 1
Hysteresis ¹⁾	without dither	%	< 5	< 3
Null shift	at $\Delta T = 55$ K	%	< 5	< 4
Null leakage flow ¹⁾	total, max.	l/min (gpm)	< 2.5 to 4.2 (0.7 to 1.1)	< 2.5 to 4.2 (0.7 to 1.1)
Pilot leakage flow ¹⁾	Tare	l/min (gpm)	1.4 (0.4)	1.7 (0.5)
Pilot flow ¹⁾ max.,	for 100% step input	l/min (gpm)	depending on hydraulic bridge 0.5 to 1 (0.1 to 0.3)	
Spool stroke		mm (inch)	± 2.54 (0.1)	± 1.3 (0.05)
Spool drive area		cm ² (inch ²)	0.75 (0.3)	0.75 (0.3)

¹⁾ measured at 210 bar (3045 psi) pilot or operating pressure, respectively, fluid viscosity of 32 mm²/s (0.05 in²/s) and fluid temperature of 40 °C (104 °F)

TYPICAL CHARACTERISTIC CURVES MEASURED WITHOUT DROPPING ORIFICE
 measured at 210 bar (3045 psi) pilot or operating pressure, respectively,
 fluid viscosity of 32 mm²/s (0.05 in²/s) and fluid temperature of 40 °C (104 °F)

Step response standard valve

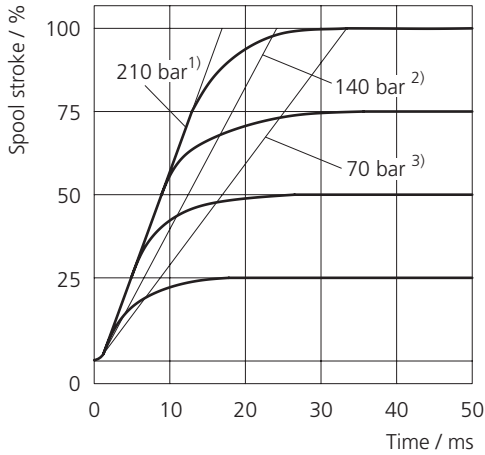

Step response high response valve

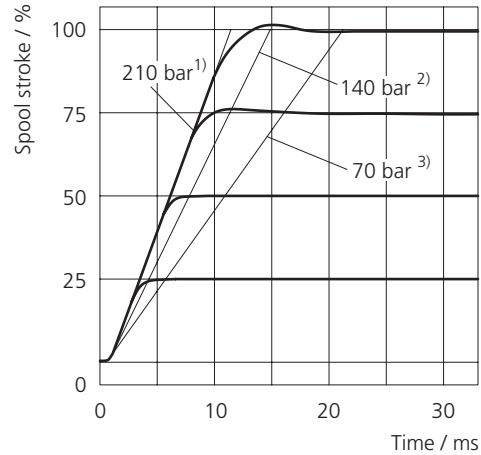

Frequency response standard valve

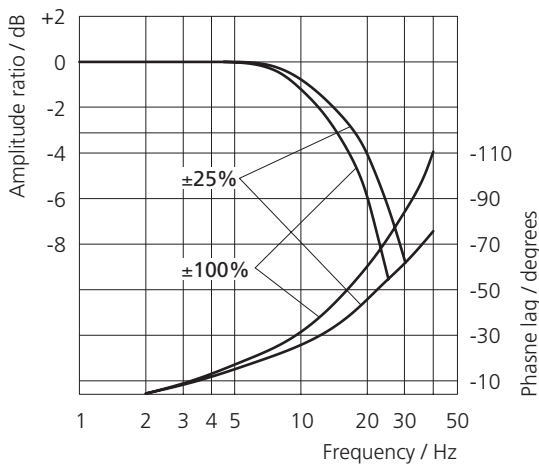

Frequency response high response valve

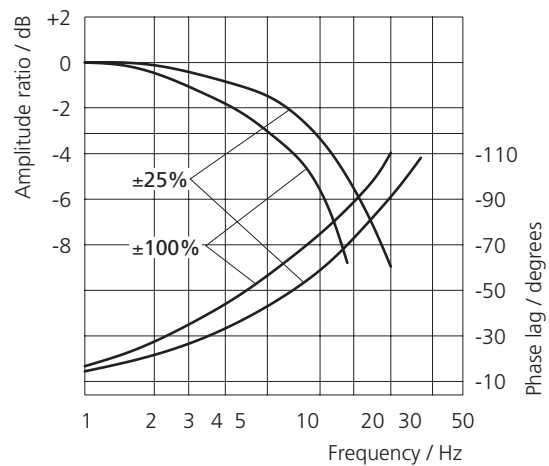

- 1) 210 bar = 3045 psi
- 2) 140 bar = 2030 psi
- 3) 70 bar = 1015 psi

SPARE PARTS AND ACCESSORIES

O-rings (included in delivery) for P, T, T ₂ , A, B	5 pieces	ID 12 x Ø 2 (ID 0.47 x Ø 0.08)	NBR 85 Shore -66117-012-020	FPM 85 Shore A25163-012-020
for X	1 piece	ID 8 x Ø 2 (ID 0.31 x Ø 0.08)	-66117-008-020	A25163-008-020
Mating connector, waterproof IP 65 (not included in delivery) 4-pole Mil C50515/14S-2S		for cable dia min. Ø 6,5 mm, max. Ø 9,5 mm min. Ø 0.25 in, max. Ø 0.37 in		B46744-004
Flushing plate		for P, A, B, T, T ₂ , X, Y B67728-001	for P, T, T ₂ , X, Y B67728-002	for P, T, T ₂ , und X, Y B67728-003
Mounting manifolds	see special data sheet			
Mounting bolts (not included in delivery) M 6 x 70 DIN EN ISO 4762-10.9	4 pieces	required torque 13 Nm (115 lb in)	A03665-060-070	
Replaceable filter		100 µm nominal	A67999 100 ¹⁾	
O-rings for filter replacement for filter	1 piece	ID 13 x Ø 1,5 (ID 0.51 x Ø 0.06)	NBR 85 Shore -66117-013-015	FPM 85 Shore A25163-013-015
for filter cover	1 piece	ID 17 x Ø 2 (ID 0.67 x Ø 0.08)	-66117-017-020	A25163-017-020
Screw plug port X	1 piece	M 4 x 6 DIN EN ISO 4762-8.8	-66098-040-006	
Seal for screw plug	1 piece	ID 4,5 / AD 7 (ID 0.18 / AD 0.28)	A25528-040	

¹⁾ For standard models, others on request

ORDERING INFORMATION

Model number

Type designation

D631

.

Specification status	
-	Series specification
E	Preseries specification
Z	Special specification
K	Intrinsically safe valve

Model designation	
	assigned at the factory

Factory identification	
	assigned at the factory

Valve version	
P	Standard valve
H	High response valve

Rated flow		
	$\Delta p_N = 5$ bar per land ($\Delta p_N = 73$ psi per land)	$Q_N / l/min$ bei $\Delta p_N = 35$ bar (Q_N / gpm at $\Delta p_N = 500$ psi)
05	2 (0.5)	5 (1.3)
10	4 (1.1)	10 (2.6)
20	8 (2.1)	20 (5.3)
40	16 (4.2)	40 (10.6)
60	24 (6.3)	60 (15.8)
80	30 (7.9)	75 (19.8)

Maximum operating pressure		
F	210 bar	At $p_x \leq 210$ bar (3045 psi) (X external) operating pressure in port P, A and B up to 315 bar possible 315 bar (4566 psi)
J	315 bar	(with dropping orifice)

Bushing spool type	
0	Axis cut, linear characteristic
D	$\pm 10\%$ overlap, linear characteristic
X	others on request

Special equipment	
	no
M	Mechanical override

Signals for 100% spool stroke			
	Command	for rated flow Q_N	
		Valve Typ P	Valve Typ H
Q	± 15 mA Series	05 to 80	05 to 60
	$\pm 22,5$ mA Series	-	80
R	± 50 mA Series	05 to 80	05 to 60
	± 75 mA Series	-	80
Y	others on request		

Valve connector	
B	Mil C5015/14S-2P
G	DIN 43650

Seal material	
N	NBR (Buna)
V	FPM (Viton)
X	others on request

Pilot connections and pressure		
A	15 to 210 bar (217 to 3045 psi)	internal supply
C	15 to 210 bar (217 to 3045 psi)	external supply
E	25 to 315 bar (363 to 4565 psi)	internal supply
G	25 to 315 bar (363 to 4565 psi)	external supply

Spool position without electrical signal P ¹⁾	
A	P \blacktriangleright B, A \blacktriangleright T
B	P \blacktriangleright A, B \blacktriangleright T
M	Mid position

Pilot stage	
F	Standard response for valve version "P"
G	Highresponse for valve version "H"

¹⁾ Control pressure

Preferred configurations are highlighted.
 All combinations may not be available.
 Options may increase price.
 Technical changes are reserved.



**Argentina
Australia
Austria
Brazil
China
Finland
France
Germany
India**

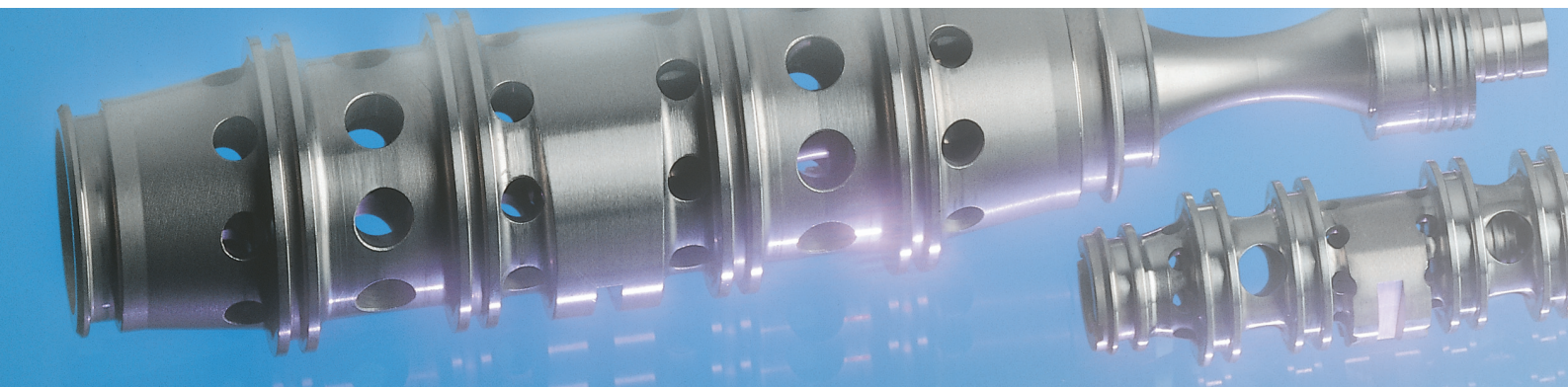

**Ireland
Italy
Japan
Korea
Luxembourg
Norway
Philippines
Russia
Singapore
Spain
Sweden
United Kingdom
USA**

MOOG

Moog GmbH
Hanns-Klemm-Straße 28
71034 Böblingen
email: sales@moog.de
www.moog.de
Telefon (0 70 31) 622-0
Telefax (0 70 31) 622-191

D631.en.09.02