

Operating Instructions for

Servocontroller T161

CAN Profile Mode



Version	Date	Author	Comments	Effectivity
orig.	1 July 97	SRF	New edition of the former product information to meet CE standards	All
Rev. a	1. Feb. 98	DRK	Corrected version	All
Rev. b	10. Feb. 98	DRK	Further corrected version	All
Rev. c	17. Apr. 98	DRK	Further corrections	All

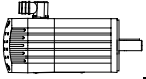

Contents

1. Introduction
2. System Description
3. Installation
4. Servocontroller CAN Profile Mode
5. Power Supply T160-9xx
6. Rack and Backplane
7. Servomotors
8. Maintenance and Service

Europe and Asia	America
MOOG GmbH	MOOG Inc. / NADO Division
Hanns-Klemm-Straße 28	Jamison Road
71034 Böblingen	EAST AURORA, NY 14052
Germany	U.S.A.
Telephone: +0049 - 7031 - 622 - 0	Telephone: +001 - 716 - 687 - 2000
Fax: +0049 - 7031 - 622 - 100	Fax: +001 - 716 - 687 - 4870

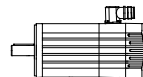

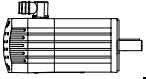

1 Introduction

This manual describes a system with one or more servo drives made by MOOG. The servo drive comprises a brushless AC servomotor, a servocontroller, a power supply, a backplane and a rack. The components described operate with voltages up to 400 V. The safety instructions must be observed.

The manual is intended for the use of qualified personnel.

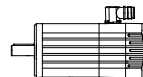

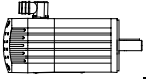

2 System Description

2.1 Components	3
2.2 Mechanical design of the motors and servocontrollers	4
2.2.1 Selection of motor	4
2.2.2 Selection of control unit.....	5
2.3 Technical data of the system.....	6
2.3.1 Standards.....	6
2.3.2 Operating and ambient temperatures	6

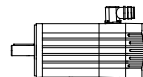

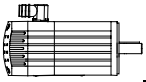

2.1 Components

A typical MOOG system is made up of the following components:

- **Isolating transformer**
The transformer serves first of all to adapt the available mains voltage to the input voltage of 3x230 VAC (3-phase operation) required by the power supply. Its second function is to ensure "safe electrical isolation" between the mains voltage and the other extra-low voltages. An autotransformer is not suitable, unless other safety precautions are also taken.
- **Power supply T160-9xx**
The power supply generates the DC bus voltage by rectifying and smoothing the input voltage of the power supply. The energy generated by a rapidly decelerating servomotor is dissipated via a ballast resistor. The LED status indicator permits rapid diagnosis of any faults occurring. A relay output permits evaluation by the host controller.
- **Servocontroller T161-90x**
The servocontroller electronically commutates the MOOG brushless servomotors. It closes the speed control loop and delivers a 3-phase sinusoidal motor current which is controlled by a current controller with large bandwidth. The LED status indicator permits rapid diagnosis of faults occurring. Two relay outputs permit evaluation by the host controller.
- **19" rack with backplane**
The 19" rack accommodates the electronic components and the backplane. The latter connects the power supply and servocontroller(s). It also provides the interfaces to the motor and for the communication with the host controller.
- **Servomotor D31x-xxx / G4xx-xxx**
The standard MOOG brushless servomotor comprises a wound stator, a rotor with permanent magnets (cobalt-samarium), a 2-pole resolver and a NTC thermistor embedded in the end turns of the stator.

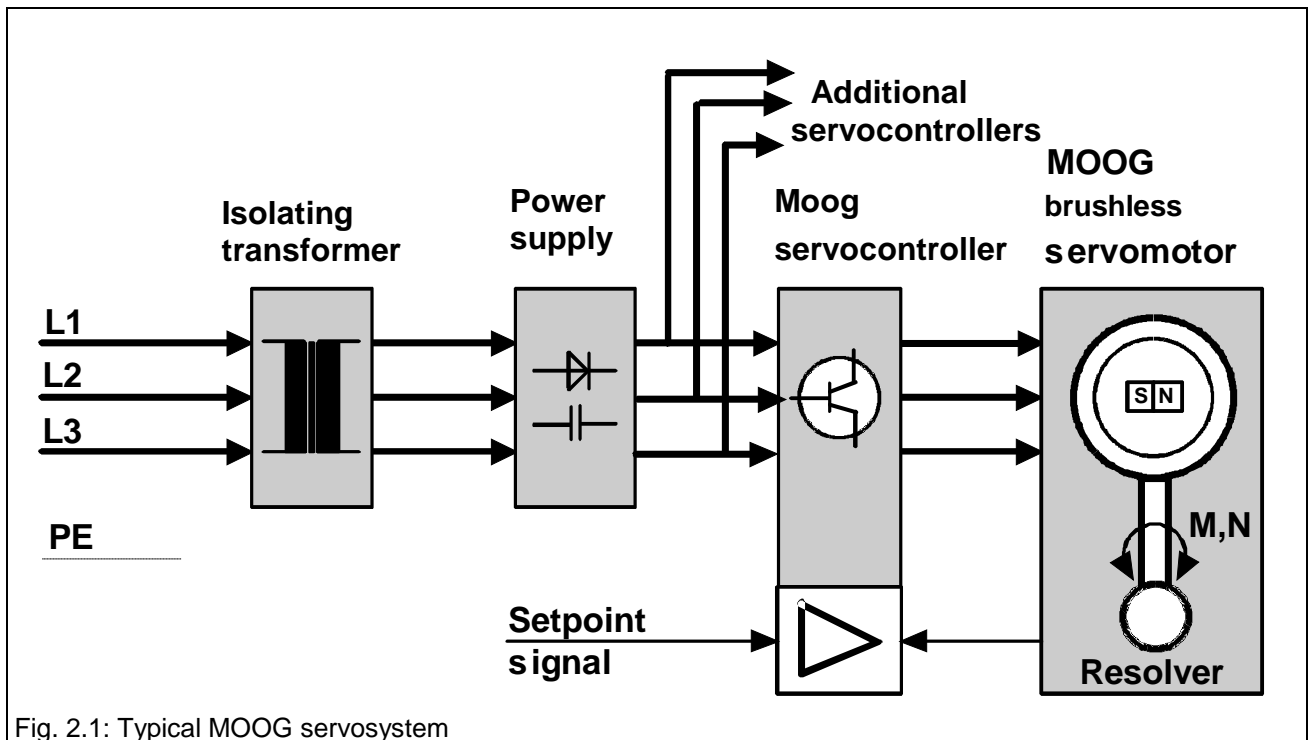
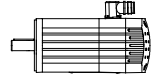

Fig. 2.1: Typical MOOG servosystem



2.2 Mechanical design of the motors and servocontrollers

2.2.1 Selection of motor

- a) The motor type is predetermined by parameters M_0 , M_{max} , n_{max} , s_1 characteristic in motor catalogue
--> Determination of k_t
- b) Application specific are required (torque characteristic $M_A(t)$, working cycle)
--> Determination of cycle time t_c , time intervals t_i , torque values M_i , M_{max}

Motor type G4xx-xxx with k_t	
$M_{A,max}(n_{A,max}) \leq M_{max}(n_{A,max})$?	
YES	NO
Calculation of the effective torque $M_{eff} = \sqrt{\frac{\sum M_i^2 \times t_i}{t_c}}$	Motor unsuitable for this application.
Calculation of the mean speed n_m Does $M_{eff}(n_m)$ lie inside the s_1 curve?	
YES	
Motor selection complete.	Motor unsuitable for this application.

Fig. 2.2: Selection of motor

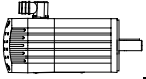

2.2.2 Selection of control unit

Motor type selected: G4xx-xxx (k_t from motor catalogue). Known torque characteristic for the application: ---> Peak torque for the application $M_{A,max}$.		
Calculation of the maximum current for the application		
$I_{A,max} = \frac{M_{A,max}}{k_t}$		
The maximum servocontroller current $I_{C,max}$ and continuous current $I_{C,m}$ can be found in chapter 4.		
$I_{A,max} \leq I_{C,max}$?		
YES	NO	
Calculation of the mean current $I_{A,m}$ for the application from the mean torque $M_{A,m}$ of the application		
$M_{A,m} = \frac{\sum M_i \times t_i}{t_c}$		
$I_{A,m} = \frac{M_{A,m}}{\eta \times k_t}$		
with $\eta = 0.85 \dots 0.9$ due to saturation of the k_t curve		
$I_{A,m} \leq I_{C,m}$?		
YES	NO	
Check motor / servocontroller combination with reference to chapter 4 (paragraph "Setting the MCO jumper L401")	Servo-controller unsuitable for this application. Repeat procedure with next larger servo-controller.	
Is a corresponding jumper position listed?		
YES		NO
Position jumper. Selection of the servocontroller is complete.		Motor / servocontroller combination not suitable for this application

Fig. 2.3: Selection of servocontroller

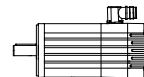

2.3 Technical data of the system

2.3.1 Standards

DIN VDE 0160 has been taken into account to a particularly strong extent in the development of these products.

The following standards have been taken into account:

Guidelines for engineering design	DIN VDE 0160	prEN 50178
Dimensioning of creepage distances and clearances	VDE 0110 Part 2	
Insulation coordination	VDE 0110 Part 1	IEC 664
General safety requirements	DIN VDE 0160	prEN 50178
Reliable isolation	DIN VDE 0160	prEN 50178
Marking	DIN VDE 0160	prEN 50178
Grounding	DIN VDE 0160	prEN 50178
Overvoltage protection	DIN VDE 0160	prEN 50178
Ambient conditions	IEC 68 Part 2-3, 2-6	
Short-circuit strength	DIN VDE 0160	prEN 50178
Mechanical stresses	IEC 68 Part 2-29	
Protection by limitation of discharge energy	DIN VDE 0160	prEN 50178
Type-testing	DIN VDE 0160	prEN 50178
EMC*	VDE 0871 EN 55011 EN 50082-1	CISPR22

* The MOOG control units series T161 can only conform to the above EMC guidelines if the MOOG EMC installation guidelines are considered and an input filter in the supply voltage lines is installed.

2.3.2 Operating and ambient temperatures

Electronic components:

Temperature for transport and storage: -25 °C to 70 °C

Operating temperature: 0 °C to 55 °C

Humidity: 5 % to 85 %, 1 g/m³ to 25 g/m³,
in accordance with prEN50178 class 3k3

Type of protection: Components must be installed into an enclosed rack.
The enclosed rack must provide at least IP54 per standard EN60529.

Ventilation: See component specification.

Installed position: Only vertical.

Overvoltage protection class: Category 2 per standard VDE0110 / IEC664

Noise: The noise depends on the user selected fan and cabinet.
The electronic components do not make noise.

Servomotors and cables:

See Chapter "7 Servomotors"

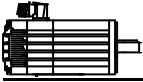

3 Installation

3.1	Safety Instructions	3
3.1.1	Explanation of Symbols used.....	3
3.1.2	Qualified personnel	4
3.1.3	Intended use	4
3.1.4	List of main safety instructions.....	4
3.2	Information on EMC	6
3.3	Installation procedure	7
3.4	Disassembly procedure	8
3.5	Overview of the overall system	9
3.6	Minimum wiring of the backplane	10
3.7	Installing and wiring of the power supply	11
3.7.1	Check name plate.....	12
3.7.2	Power supply connections	13
3.7.3	External 24 VDC supply for power supply unit (optional)	14
3.7.4	Power connection	15
3.7.5	Configuring the power supply unit for ballast resistance.....	18
3.8	Connecting the servomotors	20
3.8.1	Power cable connection	21
3.8.2	Signal cable connection	21
3.8.3	Brake control.....	22
3.9	Wiring the servocontroller inputs and outputs	23

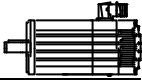

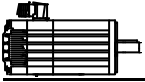

3.1 Safety Instructions

3.1.1 Explanation of Symbols used



Important!

The symbol on the left and the word "Important" are used to draw attention to safety instructions concerning a potential **hazard for persons**.

Failure to comply with these safety instructions can result in serious damage to health and can even prove fatal in extreme cases.

These safety instructions must be observed without fail.



Warning:

The symbol on the left and the word "Warning!" are used to draw attention to instructions concerning potential **damage to the servo drive or to the system as a whole**.

Such warnings must be observed without fail.



Note:

Notes contain useful information for the operator when starting up and operating the system.



Danger - High voltage (Sticker on the power supply and servomotor)

The symbol on the left indicates that the power supply operates with high voltages which can prove extremely dangerous if touched.

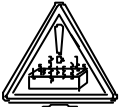

Beware of hot parts (Sticker on servomotor)

In extreme applications, the surface of the servomotor may heat up to more than 100 °C and can cause skin burns if touched. The servomotor must therefore be protected to prevent contact.



Delicate part (Sticker on servomotor)

A hammer must not be used to force the gearing / gear wheel onto the shaft when installing such parts. The screw thread in the center of the shaft must be used for this purpose. An extractor supported on the center of the shaft must be used when dismantling the parts.

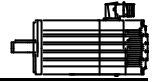

3.1.2 Qualified personnel



Important!

The components making up the drive system may only be installed and serviced by duly qualified personnel. The accident prevention regulations (UVV) and particularly VGB 4 and VGB 5 must be taken into account, as must the following VDE safety standards: VDE 100, VDE 105, DIN EN 60204 and prEN 50178.

Unqualified work on the drive components and failure to comply with the warnings contained in this manual or affixed to the components can result in serious physical injury or damage to property.

The work permitted within the scope of this manual may consequently only be undertaken by duly qualified personnel.

This includes the following people:

planning and engineering design personnel familiar with the safety guidelines for measurement and control instrumentation,

operating personnel who have been duly instructed with regard to the handling of measurement and control instrumentation and who are familiar with the operating instructions contained in this manual,

commissioning and service personnel authorized to start up, ground and mark the circuits for components and systems in accordance with safety engineering standards.

3.1.3 Intended use

The drive components have been developed and built for installation and operation in industrial systems.

The electronic components (power supply, servocontroller, backplane) are designed for installation in a rack. These electronic components do not have a separate housing and are therefore not protected against accidental contact. It is therefore absolutely essential that they be installed in a rack. The rack must additionally be installed in a closed control cabinet.

Protection against accidental contact must be ensured by installation.

3.1.4 List of main safety instructions



Danger - High voltage!

The servo drives operate with potentially lethal voltages.

The servocontroller and power supply are individual components and designed for installation in a rack in a control cabinet. The individual components do not have a separate housing and are therefore not protected against accidental contact with high voltages.

For this reason:

A rack must be used

The components must be installed in a rack before being put into operation. The rack must ensure complete protection against accidental contact. If not all the slots in the rack are used, the unused slots must be covered by filler panels.

Install the rack in a control cabinet

High voltages flow through the backplane, which must consequently be protected against accidental contact. The rack must therefore be installed in a control cabinet.

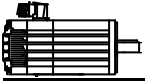

Danger - High voltage!

The servo drives operate with potentially lethal voltages.

For this reason:

Disconnect the system from the mains supply.

Before starting any work on the drive system, it must be disconnected from the power supply and secured against inadvertent reconnection by means of the master switch.

The servomotors must come to a complete stop.

Rotating servomotors can generate potentially lethal voltages by acting as generators.



Beware of charged capacitors!

The capacitors in the power supply may still be charged.

For this reason:

Note the discharge time of the capacitors.

The power supply contains capacitors which may be charged with up to 400 VDC. Wait at least 5 minutes for the capacitors to become discharged after disconnecting the voltage.

The voltage must then be measured between DC+ (X7/1) and DC- (X7/2).

Work on the power supply must not start until the voltage has dropped below 5 V.



Beware of mechanical hazards!

Servomotors can accelerate highly dynamically. They also have an enormous torque. The following points must therefore be observed when starting the system.

The danger zone of the motor must be cordoned off.

The system must feature a guard door preventing personnel from reaching into or entering the danger zone. If the guard door is opened, the drive system must be disconnected from the supply voltage immediately.

The motor may accelerate inadvertently on account of wiring faults or errors in the application software. Appropriate safety precautions must therefore be taken in the system to ensure that neither personnel nor machine components are endangered in any way.



Danger - High voltage on backplane!

High voltages flow through the backplane, as well as through some screw terminals and the soldering pins.

For this reason:

Before starting any work on the backplane, the system must be disconnected from the power supply and secured against inadvertent reconnection by means of the master switch.

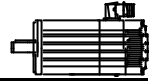

3.2 Information on EMC

(Only applies for countries in the European Community)



Exclusion of liability

The information on EMC provided here contains general recommendations to assist the manufacturer when installing RMC components made by MOOG in finished products which must conform to the requirements of EC Directive 89/336/EEC (EMC Directive). Although MOOG has exercised utmost care in compiling these recommendations, we cannot accept any liability whatsoever for claims associated with the user's individual applications. This also applies in particular with regard to non-performance, non-compliance, faults, misunderstandings and mistaken interpretation.



Note:

Responsibility for ensuring that every finished product containing these components conforms to the requirements of the EMC Directive rests entirely with the manufacturer of the finished product. MOOG cannot accept any liability whatsoever for finished products made by other manufacturers and containing 19" RMC components from MOOG.

EMC environment

The 19" RMC components from MOOG are designed for installation in industrial equipment and for operation in industrial areas. The 19" RMC components from MOOG have therefore been tested in accordance with the following EMC standards:

EN55011: Limit values and methods of measuring the radio interference of industrial, scientific and medical high-frequency equipment (ISM devices) (1991), class A limit values.

EN50082-2: Elektromagnetic compatibility (EMC)
Basic standard on immunity to interference
Part 2: Industry (1995).

Installation of the components

The 19" RMC components from MOOG are designed for installation in an assembly comprising a rack, fan and backplane which must in turn be installed in a control cabinet or housing. For the sake of simplicity, the assembly comprising the rack, fan and backplane will henceforth simply be referred to as the rack. The control cabinet or housing will be referred to as a control cabinet. Rack and control cabinet must be provided by the manufacturer of the finished product.

The rack used must have been developed or modified for optimized EMC grounding and shielding (e.g. Schroff Europac Lab HF Subrack, see order information). All 19" RMC components or modules from MOOG must be firmly installed in the rack. All screw connections must be tightly secured.

All metal covers (filler panels, side panels, covers, etc.) belonging to the rack must be fitted and a continuous ground connection guaranteed between all panels. All ground connections between the rack and the control cabinet must be securely mounted and a continuous ground connection guaranteed.

To ensure an optimum EMC shield, the control cabinet should have a continuous ground connection between all metal panels (frame, side panels, top, baseplate, etc.). A control cabinet which has been designed to provide an optimum EMC shield can be used for this purpose.

The manufacturer of the finished product must take into account the effects of additional interference due to other modules, systems or power supplies installed in the finished product, as well as the interaction between actual and potential sources of interference in the finished product. The manufacturer of the finished product is responsible for taking suitable precautions to minimize such interference in the finished product, for example by maintaining a safe distance between such parts or shielding them inside the product. He must decide which is the most efficient method in every single finished product.

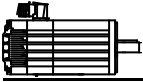

Where possible, shielded cables with fully shielded connector housings should always be used. The cable shield must be connected to the connector shields over the full 360° in order to ensure a continuous all-round ground connection. All cable connections to the backplane must be tightly secured. In particular, all screws in the ground connections of the connector shields must be securely tightened. Cables must be routed as far apart as possible to avoid interference in the control cabinet. If cables must be crossed, they should do so at an angle of 90°. This reduces the interference to a minimum. Here too, the manufacturer of the finished product must decide which is the most efficient method for each individual product.

Further details on filtering, grounding and shielding can be found in this manual.

3.3 Installation procedure

This chapter on installation refers to all servocontrollers in series T161 and is therefore very general. The servocontrollers T161 are available with different software versions and different functions. Three versions are currently available:

Servocontroller with analog setpoint for speed or torque

This constitutes the basic version. The higher-ranking positioning control specifies a speed for the servocontroller via an analog signal (-10 V .. +10 V). The drive reports its actual position to the control via an encoder simulation (simulation of an incremental encoder).

Servocontroller with connection to the CAN bus and Interpolation Mode protocol

In this version, the control system specifies setpoint positions for the servocontroller at fixed intervals (every 6..64 milliseconds) via the CAN bus. The servocontroller interpolates between the individual setpoint positions and follows the specified path. Extensive status messages are output to the control system and make troubleshooting easier. The system is fully digital and thus insusceptible to external disturbances and drift.

Servocontroller with connection to the CAN bus and Profile Mode protocol

In this version, the control system only sends short commands to the servocontroller via the CAN bus. These commands are evaluated by the servocontroller and executed without further assistance by the control system. Positioning is achieved through specification of the target position, max. speed and max. acceleration. The servocontroller generates its own path and reports to the control system when it reaches the target position. Other functions are also available, such as electrical gearing, cam functions, etc. Extensive status messages are output to the control system and make troubleshooting easier. The system is fully digital and thus insusceptible to faults and drift.

Servocontroller versions with different functions \neq different wiring

The servocontroller versions with different functions also require different wiring, since the inputs and outputs are differently defined by software.

Attention is therefore drawn to the appropriate servocontroller chapter during the installation procedure.

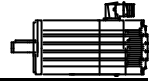

3.4 Disassembly procedure

The servodrives described here operate with voltages which can cause serious damage to health if touched. The following safety instructions must therefore be observed when dismantling the drives and also when making minor changes to the wiring.



Danger - High voltage!

The servo drives operate with potentially lethal voltages.

For this reason:

Disconnect the system from the mains supply.

Before starting any work on the drive system, it must be disconnected from the power supply and secured against inadvertent reconnection by means of the master switch.

The servomotors must come to a complete stop.

Rotating servomotors can generate potentially lethal voltages by acting as generators.



Beware of charged capacitors!

The capacitors in the power supply may still be charged.

For this reason:

Note the discharge time of the capacitors.

The power supply contains capacitors which may be charged with up to 400 VDC. Wait at least 5 minutes for the capacitors to become discharged after disconnecting the system from the mains.

The voltage must then be measured between DC+ (X7/1) and DC- (X7/2).

Work on the power supply must not start until the voltage has dropped below 5 V.



Danger - High voltage on backplane!

High voltages are present at the backplane, as well as through some screw terminals and the soldering pins.

For this reason:

Before starting any work on the backplane, the system must be disconnected from the mains voltage and secured against inadvertent reconnection by means of the master switch.

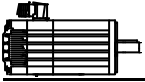

3.5 Overview of the overall system

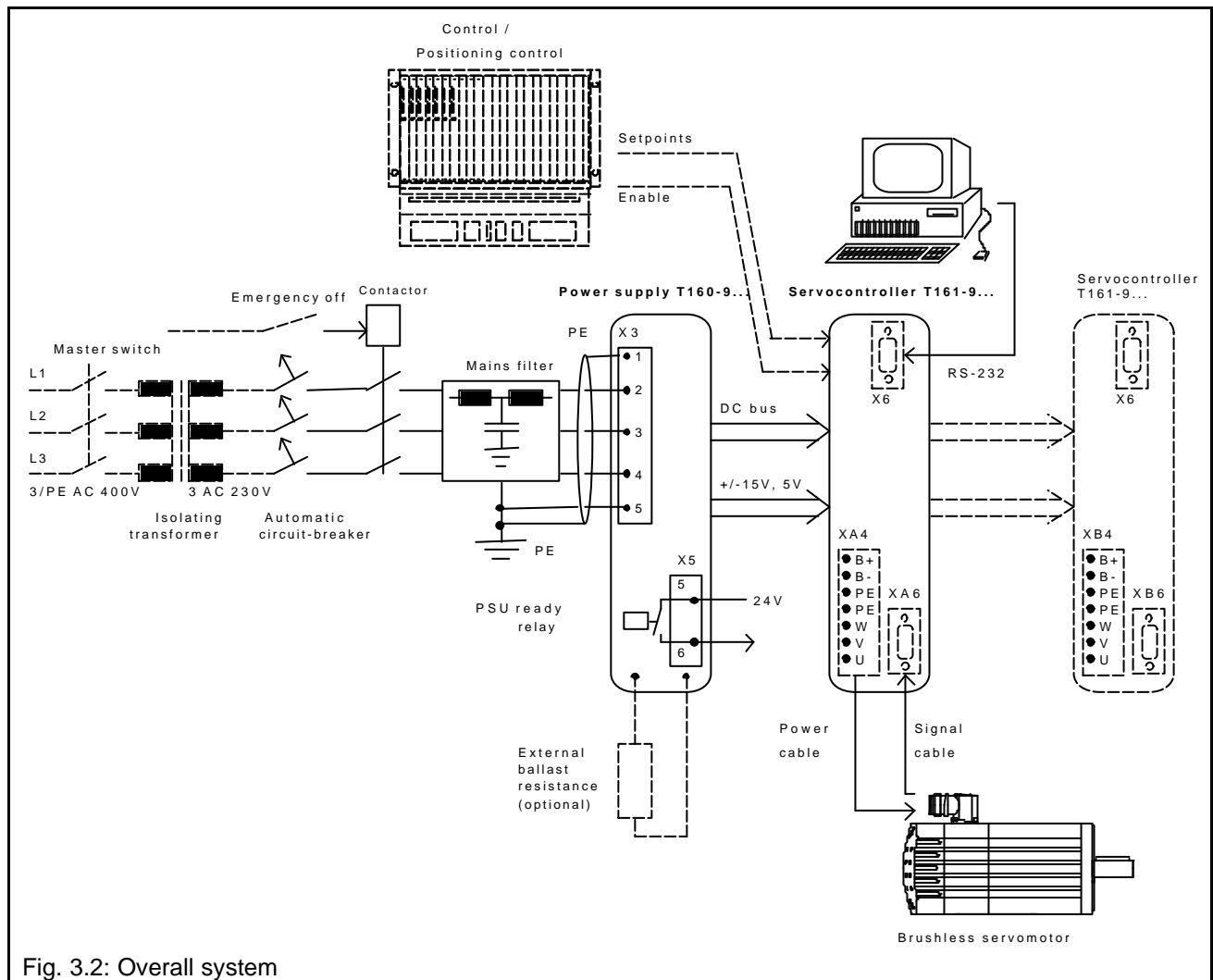
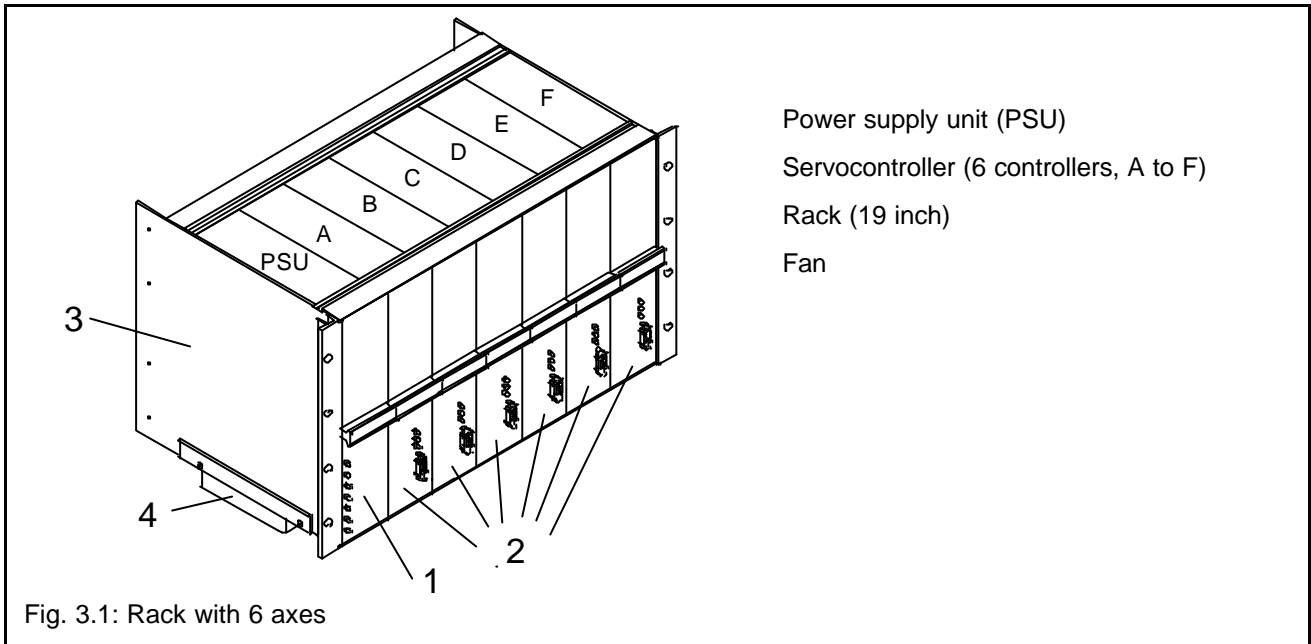

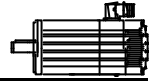

3.6 Minimum wiring of the backplane

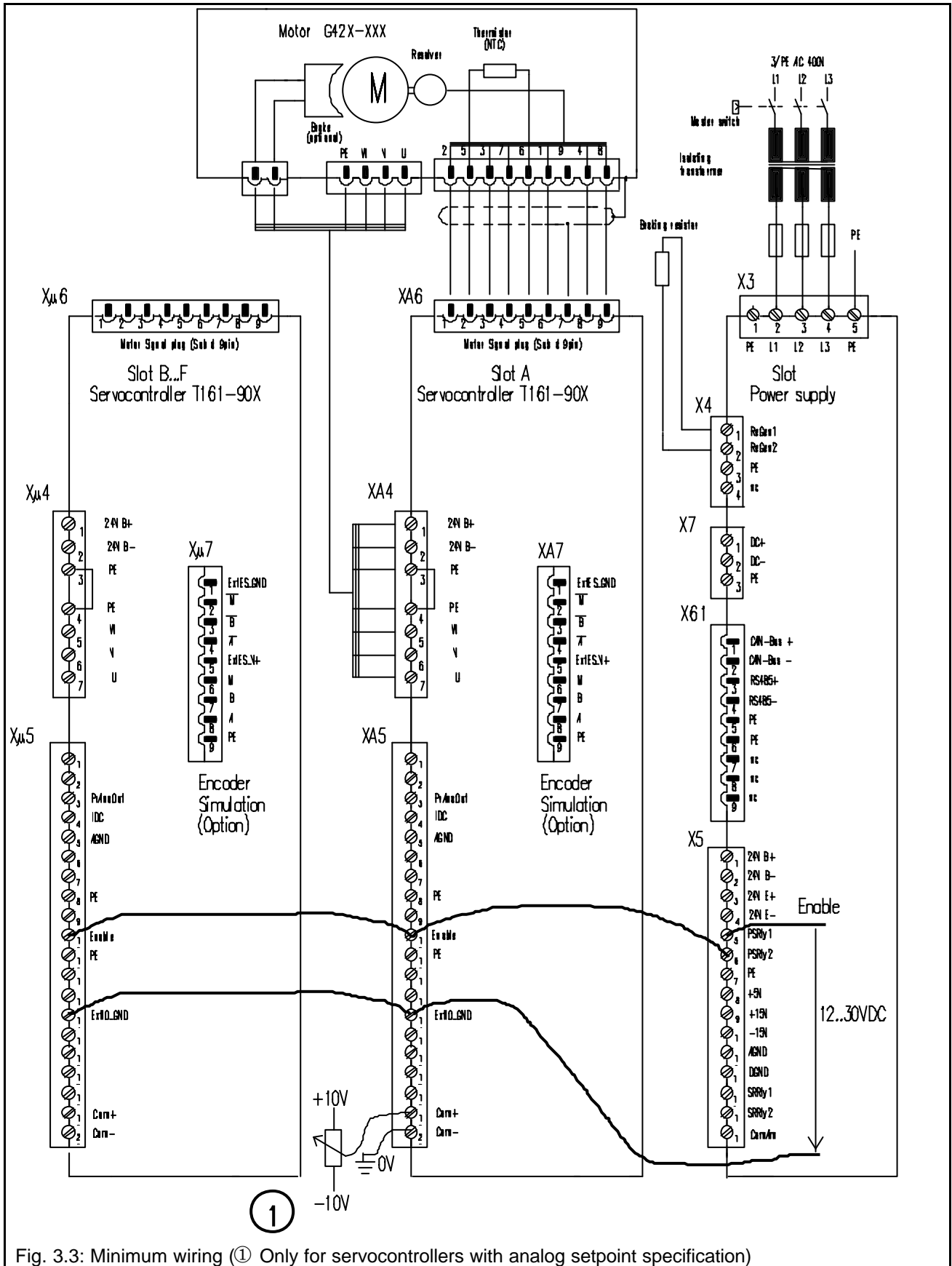

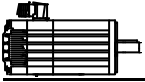

3.7 Installing and wiring of the power supply



Danger - High voltage!

The servo drives operate with potentially lethal voltages.

For this reason:

Disconnect the system from the mains supply.

Before starting any work on the drive system, it must be disconnected from the power supply and secured against inadvertent reconnection by means of the master switch.

The servomotors must come to a complete stop.

Rotating servomotors can generate potentially lethal voltages by acting as generators.



Beware of charged capacitors!

The capacitors in the power supply may still be charged.

Note the discharge time of the capacitors.

The power supply contains capacitors which may be charged with up to 400 VDC. Wait at least 5 minutes for the capacitors to become discharged after disconnecting the system from the mains.

The voltage must then be measured between DC+ (X7/1) and DC- (X7/2).

Work on the power supply must not start until the voltage has dropped below 5 V.



Warning:

A fan is required if **more than four** servocontrollers are installed.

Then the fans must be switched on as soon as voltage is applied to the power supply.

If the power supply requires an external 24 VDC supply, the fan must be switched on as soon as the 24 VDC supply is connected.

Five points must be noted in addition to the safety instructions when carrying out this work:

Does the power supply unit require an external 24 VDC supply?

Is the power supply unit operated with one or three phases?

Which ballast circuit is planned?

Does the power supply unit require a fan?

Install a mains filter (EMC precaution).

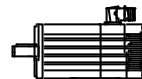

3.7.1 Check name plate



indicates the Revision Index.
This manual applies for all revisions.

SerNo: T0123 indicates the serial number.
The serial number is incremented with every part produced.



The name plate serves to identify the product.
For this reason:
Check whether the name plate on the device matches the name plate illustrated above.
This documentation must not be used for commissioning and startup if the name plates do not match.
Devices without name plate are not covered by the manufacturer's warranty and must not be put into operation.

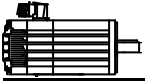

3.7.2 Power supply connections

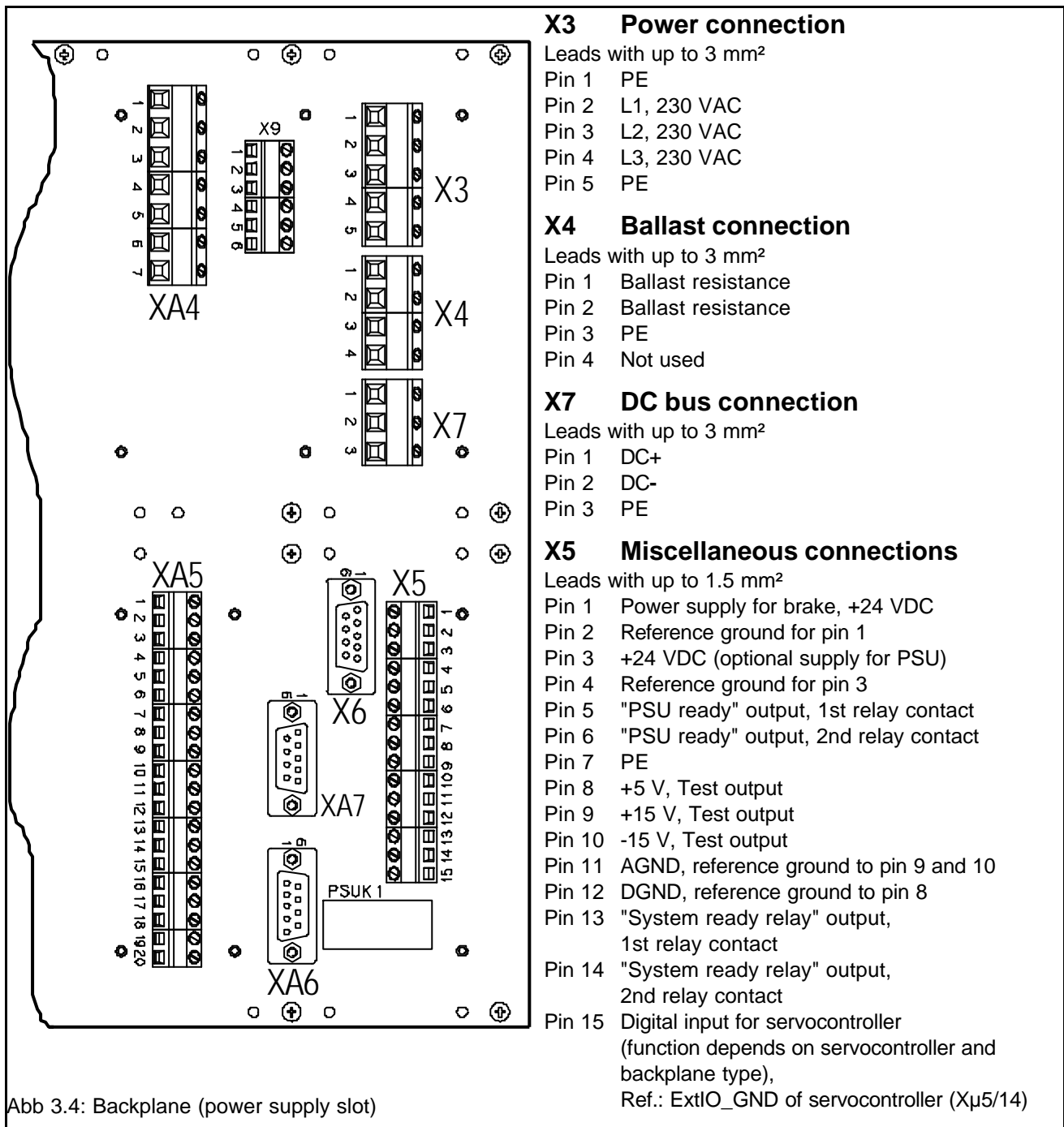

Terminal types for X3, X4 and X7

Type: Phoenix GSMKDS3 (angled screw terminal)
 Wire cross-sectional area: max. 3 mm², min. 2.5 mm²

Terminal type for X5

Type: Phoenix SMKDS1.5 (angled screw terminal)
 Wire cross-sectional area: max. 1.5 mm²

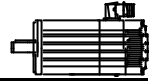

3.7.3 External 24 VDC supply for power supply unit (optional)

Power supply unit T160 - 901 # - 00 - 1#

This power supply unit does not require an external 24 VDC supply.

Power supply unit T160 - 902 # - 00 - 1#

Power supply unit T160 - 932 # - 00 - 1#

These two power supply units require an external 24 VDC supply. The voltage is connected to terminal X5-pin 3 (positive) and terminal X5-pin 4 (negative).

The +5 V and ±15 V are generated from this 24 VDC supply. This ensures that the microcomputer, the position measurement and an optional CAN bus remain fully functional if the power has to be disconnected for operational reasons, e.g. following an Emergency SWITCH OFF.



Important: A 24 VDC supply with reliable insulation must be used!

The power supply providing the 24 VDC for the MOOG power supply unit must be reliably insulated from the mains voltage and must conform to standard EN 60950.

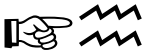

EMC recommendation:

The connecting leads must be routed through a ferrite core in order to filter out the conducted DC interference. The ferrite core must be positioned as close to the power supply unit as possible so that the connection between core and terminal is as short as possible. It must be ensured that both leads are routed in parallel. They must both be inserted into the hole of the core in the same direction and both leads must have the same number of turns (four turns) (see figure below).

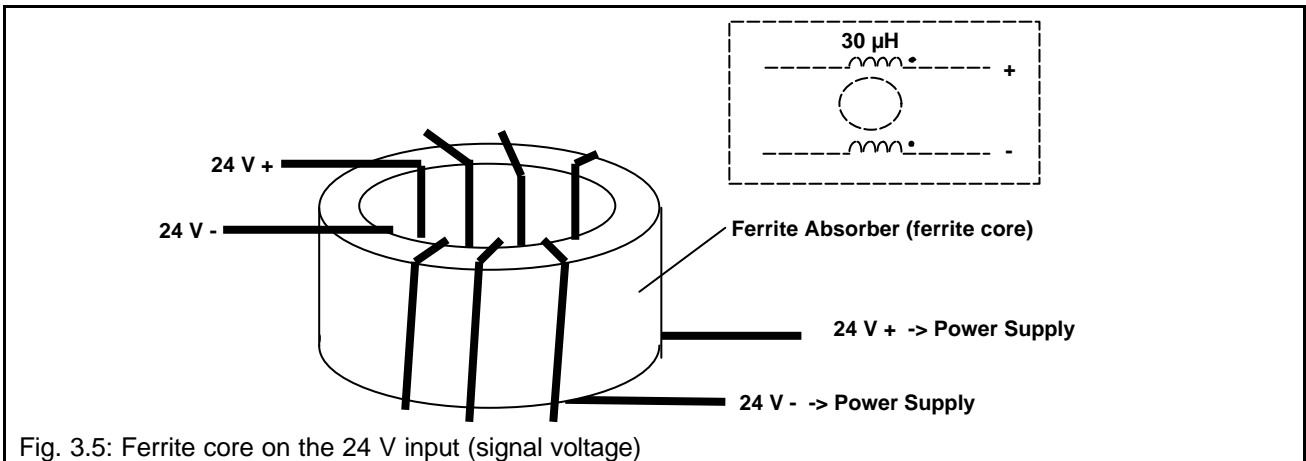
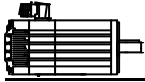

Fig. 3.5: Ferrite core on the 24 V input (signal voltage)



3.7.4 Power connection

The power supply unit can be operated with either a one-phase or three-phase AC voltage:

	Minimum	Nominal	Maximum
Supply voltage	207 VAC	230 VAC	254 VAC
Mains frequency	44 Hz	50 Hz	66 Hz
Fuse		16 A slow-blow *)	

*) A 3-phase automatic circuit-breaker must be used for 3-phase operation in order to ensure that all phases are tripped at the same time in the event of a fault!



Important: Isolating transformer required

The isolating transformer is required in order to maintain the specified isolation (creepage distances and clearances) in relation to unprotected small-signal auxiliary voltages. The isolating transformer must conform to standard EN 60204-1. The protective earth conductor must be connected.

If **other precautions** are taken,

- the power supply unit can be connected directly to the mains supply for one-phase operation,
- an autotransformer can be used to adjust the voltage for three-phase operation.

One-phase operation:

In one-phase operation, the voltage between live and neutral is 230 VAC. An isolating transformer with 1:1 transformation ratio must be used. The secondary terminals of the isolating transformer are connected to terminal X3-pin 2 and X3-pin 3. The protective earth conductor must also be connected.

Three-phase operation:

The nominal voltage between the power supply unit terminals must be equal to 230 VAC. The phase-to-phase voltage of a normal 3x400 VAC 3-phase mains supply must be stepped down to 3x230 VAC by means of an isolating transformer connected to terminal X3. The protective earth conductor must be connected.



Note:

Leakage currents flow on the PE conductor if no isolating transformer is used.

The leakage current may exceed 3.5 mA under corresponding operating conditions. It is therefore recommended to connect an additional PE conductor of at least 10 mm² to the rack (see VDE 0160).

The leakage currents are drastically reduced when using an isolating transformer.

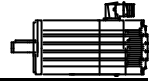

3.7.4.1 Configuring the power supply for 1-phase or 3-phase operation

Jumper JW1 must be reconnected for this purpose (see figure 3.8):

Mode of operation	Position of jumper JW 1
1-phase	On the mark 1 ϕ
3-phase	On the mark 3 ϕ

If one phase fails in 3-phase operation, the "power supply ready" relay in the power supply unit opens and the fault is indicated. The red LED 3- lights up on the front panel. The power supply unit remains operational however. Since the current is no longer distributed over all three phases following a phase failure, the power supply unit may heat up when high power levels are output. The connected servocontrollers are disabled via an internal fault signal when the temperature limit is reached.

3.7.4.2 Important information



Warning: Note the switch-on sequence!

Switching on
If the power supply unit has an external 24 VDC supply, the 24 VDC must be switched on first. The power can be switched on after a delay of 2 seconds.

Switching off
Either the power can be switched off first and then the 24 VDC supply or the power and 24 VDC supply can be switched off at the same time (e.g. via the master switch on the machine).
If the 24 VDC supply is switched off but the power remains on due to a fault, the power must be switched off by hand. Wait at least 5 minutes before switching the power supply unit on again.

Short time disconnection of the power
If the power is only to be disconnected for a short time, a delay of at least 2 seconds must be allowed before reconnecting the power.



Warning: Note the softstart!

Inrush current limitation(= softstart)
The power supply unit is protected by an inrush current limitation. The DC bus capacitors are charged via a resistance which is bridged upon expiration of the charging time (1 second).

None of the servocontrollers must be enabled while the softstart is active, otherwise the charging current will flow into the motor instead of the capacitors, causing the softstart to have no effect. The fuse before the power supply unit will be tripped by the high switch-on current in this case.

"PSU ready" relay (terminals X5/5 and X5/6)
The relay contact is closed as soon as the softstart procedure is complete and the power supply unit is ready to supply the servocontrollers with power. The relay contact is opened in the event of a fault.



Note:
MOOG recommends the circuit illustrated in Fig. 3.6 to be used.

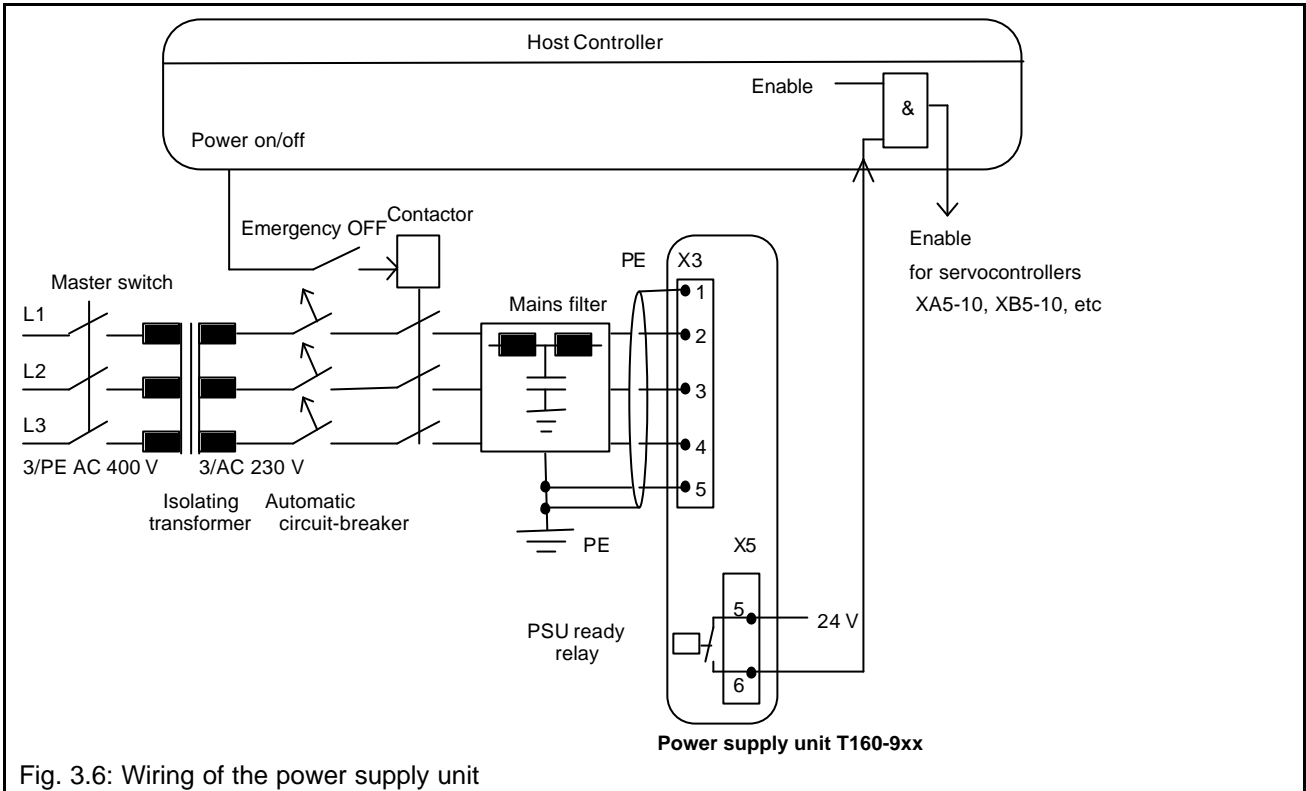
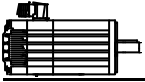

Fig. 3.6: Wiring of the power supply unit



Important: Emergency OFF buttons must be used

The Directive concerning the safety of machines specifies that an Emergency OFF switch must be installed in the system so that the servo drives can be disconnected from the mains voltage in an emergency.



EMC recommendation:

The connecting leads must be routed through a ferrite core in order to filter out the conducted DC interference. The ferrite core must be positioned as close to the power supply unit as possible so that the connection between core and terminal is as short as possible. It must be ensured that all three leads are routed in parallel. They must all be inserted into the hole of the core in the same direction and must all have the same number of turns (see diagram below).

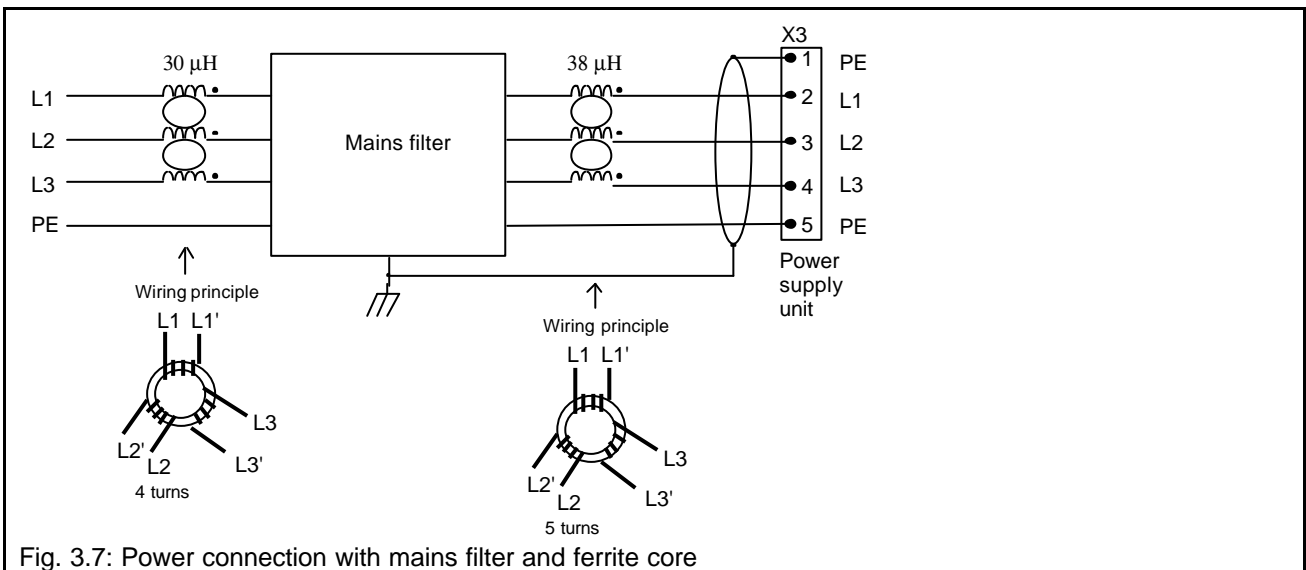
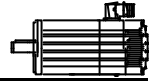

Fig. 3.7: Power connection with mains filter and ferrite core



3.7.5 Configuring the power supply unit for ballast resistance

The following notes must be observed without fail when using an external ballast resistance:



Danger - High voltage!

Voltages of up to 400 VDC may be present at the external ballast resistance. It must therefore be protected against accidental contact.

Recommendation: cover with a perforated metal sheet.

EN 60204 "Safety of electrical machines" requires that the housing of a ballast resistance must be according to at least IP22.



Danger - High temperatures!

The ballast resistance can become very hot during operation. It must therefore be installed so that its high temperature does not constitute a source of danger. The cover (perforated metal sheet) may also become very hot and must therefore be protected against accidental contact.



EMC recommendation:

The ballast resistance should be installed in a perforated case to protect it against accidental contact. The perforated metal sheet also prevents the emission of electromagnetic waves and is consequently required for compliance with EMC regulations. A shielded cable must be used for connection. The shield is connected at both ends to the backplane and to the perforated case.

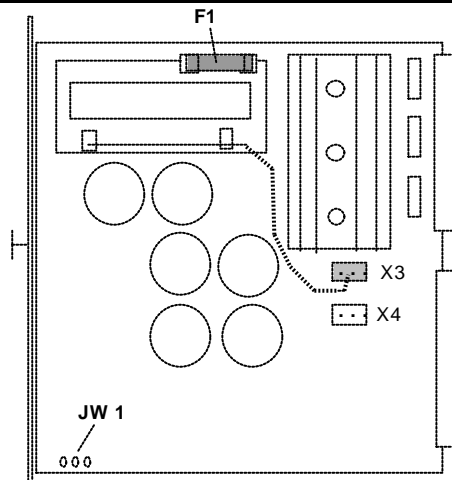
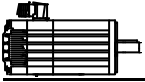

Fig. 3.8: Various positions on the power supply unit



3.7.5.1 Power supply units T160 - 901 # - 00 - 1# and T160 - 902 # - 00 - 1#

These two power supply units can be configured for three different options:

Option	External ballast resistance	Fuse F1	Connector position	Continuous regeneration power	Peak regeneration power
1 (Configuration upon delivery)	None	SIBA 1.6 A / 415 V slow-blow	X 3	40 W	2,800 W for 100 ms
2	50 Ohm	SIBA 2.5 A / 415 V slow-blow	X 4	200 W	2,800 W for 300 ms
3	10 Ohm	SIBA 8 A / 415 V slow-blow	X 3	235 W	16,900 W for 100 ms

Plug the connector into the position indicated in the table above.
The connector is plugged into position X3 when the power supply unit is delivered.

Replace fuse F1 with the fuse specified in the table (options 2 and 3 only).
A 1.6 A fuse is fitted in the power supply unit upon delivery. The other two fuses are enclosed in the package.
Note that the three fuses are differently rated and therefore CANNOT be used as replacements. The fuse may only be replaced by another fuse with the same rating if it is tripped.

Connect the external ballast resistance (options 2 and 3 only).
The resistance value of the ballast resistor must not be lower than specified in the table. It must be designed for both the continuous regeneration power and the peak regeneration power as well.
The ballast resistance is connected to terminals X4-pin 1 and X4-pin 2. The protective earth conductor is connected to terminal X4-pin 3 and to the cover of the ballast resistance.

3.7.5.2 Power supply unit T160 - 932 # - 00 - 1#

An external ballast resistance is required for this power supply unit. Operation without external ballast resistance is impossible.

Option	External ballast resistance	Fuse F1	Connector position	Continuous regeneration power	Peak regeneration power
1 (Configuration upon delivery)	10 Ohm	SIBA 10 A / 415 V slow-blow	--	900 W	14,000 W for 160 ms

Connect the external ballast resistance.
The resistance value of the ballast resistor must not be lower than specified in the table. It must be designed for both the continuous regeneration power and the peak regeneration power as well.
The ballast resistance is connected to terminals X4-pin 1 and X4-pin 2. The protective earth conductor is connected to terminal X4-pin 3 and to the cover of the ballast resistance.

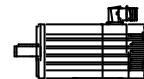

3.8 Connecting the servomotors



Danger - High voltage!

The servomotors operate with potentially lethal voltages. The following points must be noted before starting any work on the servomotors or wiring.

Disconnect the system from the power supply.

Note the safety regulations specified in Chapter 3.1 "Safety Instructions".

The servomotors must come to a complete standstill.

Rotating servomotors can generate potentially lethal voltages by acting as generators.

It is **NOT** sufficient to simply disable the drive.



Important!

The motor must be wired and tested conscientiously.

Power cable

An incorrect phase sequence can cause the motor to accelerate in an uncontrolled manner when switched on. The torque is fed inversely and the control system confused totally by the incorrect phase sequence.

Signal cable

Incorrect connection of the leads can cause the motor to accelerate in an uncontrolled manner when switched on. Due to the reversed polarity, position evaluation is effected in the opposite direction to the sense of the motor rotation and the control system utterly confused.

Two points must be noted in addition to the safety instructions when carrying out this work:

Motor type

This description applies for all MOOG motors with the designation G42x-xxx.

Customized MOOG motors and motors built by other manufacturers may only be operated in consultation with MOOG.

Does the motor have a brake or not?

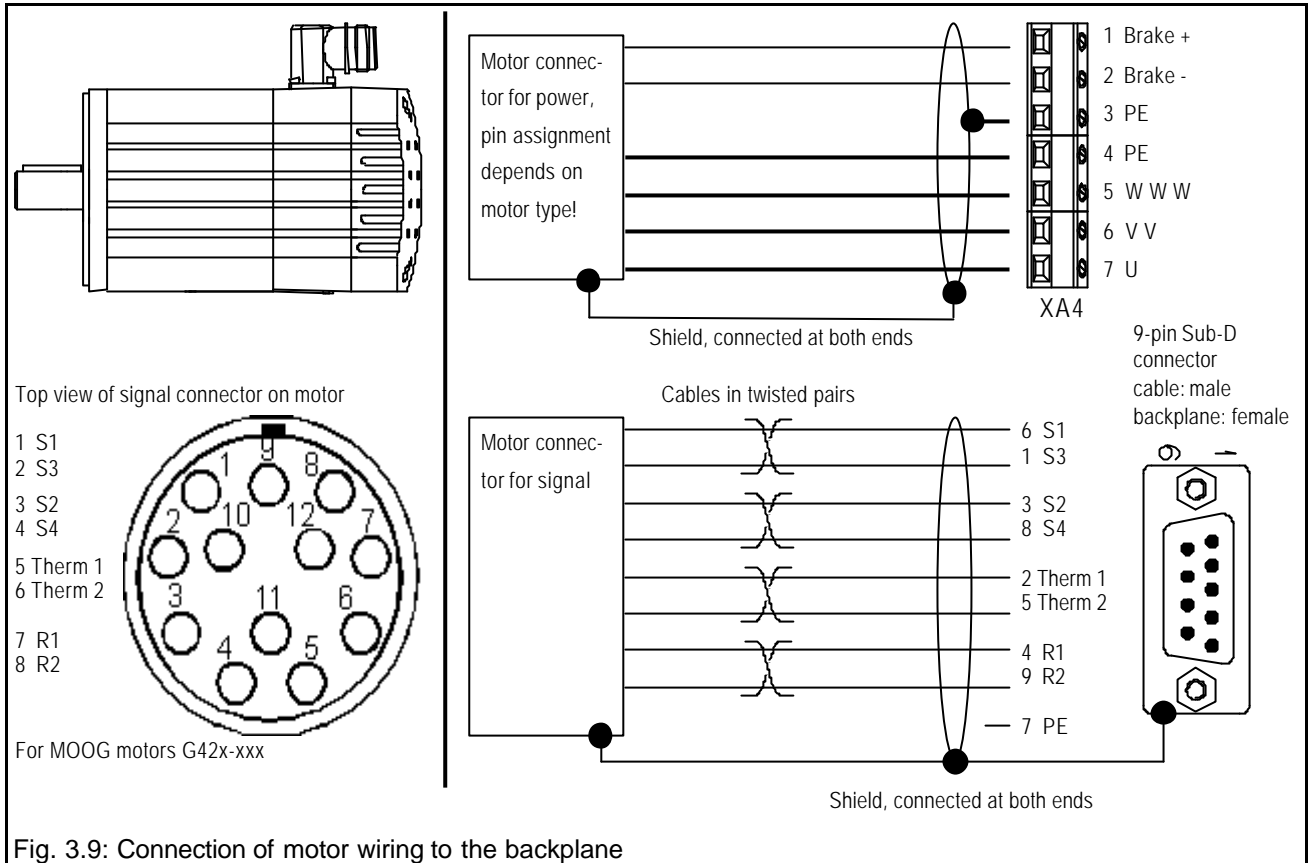
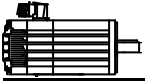

Fig. 3.9: Connection of motor wiring to the backplane

3.8.1 Power cable connection

Power connectors XA4, XB4, XC4, ..., XF4

Type: Phoenix GSMKDS3 (angled screw terminal)
wire cross-sectional area: max. 3 mm²

Pin 1	24 V B+	Positive pole for 24 VDC brake in motor Important: Note the chapter "Brake control".	Output
Pin 2:	24 V B-	Negative pole for Pin 1	Output
Pin 3:	PE	For shield connection	PE
Pin 4:	PE	Protective earth conductor	PE
Pin 5:	W W W	Motor phase W	Output
Pin 6:	V V	Motor phase V	Output
Pin 7:	U	Motor phase U	Output

3.8.2 Signal cable connection

Resolver connectors XA6, XB6, XC6, ..., XF6

Type: female 9 pole sub-D connector on the backplane
wire cross-sectional area: --

Pin 1	S3	Resolver feedback, SIN+	Input
Pin 2:	Therm 1	Temperature sensor connection (NTC thermistor)	Output, Ref.: Pin 5
Pin 3:	S2	Resolver feedback COS+	Input
Pin 4:	R1	Resolver feeding, positive	Output, Ref.: Pin 9
Pin 5:	Therm 2	Temperature sensor connection (NTC thermistor)	Input
Pin 6:	S1	Resolver feedback, SIN-	Input
Pin 7:	PE	Protective earth conductor	Input/Output
Pin 8:	S4	Resolver feedback COS-	Input
Pin 9:	R2	Resolver feeding, negative	Input

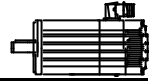

3.8.3 Brake control



Information on the motor brake

The following points must be noted with regard to the motor brake:

Brake control

The brake is released with 24 VDC. It engages as soon as the voltage is interrupted. Only brakes which operate according to this principle can be controlled.

Select the appropriate backplane

The servocontroller can only control the brake if brake relays are installed on the backplane.

Holding brake only

The motor brake is a holding brake and holds the motor shaft. If the brake is used for dynamic braking several times, it will become worn and the braking effect will deteriorate. The brake is not designed to take over safety functions.

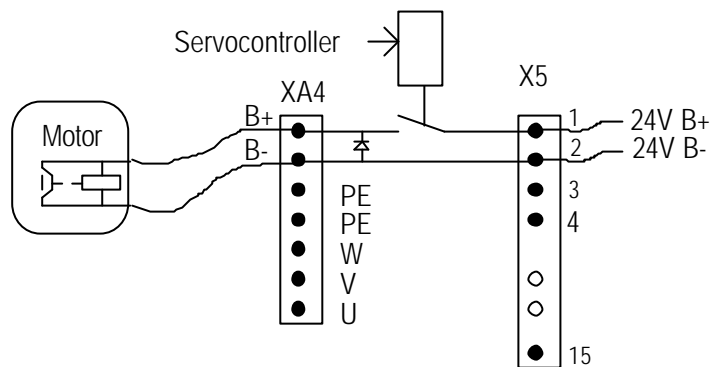

Fig. 3.10: Brake control by the servocontroller.
The brake is released when current flows and engages when de-energized.



EMC recommendation:

The connecting leads must be routed through a ferrite core in order to filter out the conducted DC interference. The ferrite core must be positioned as close to the power supply unit as possible so that the connection between core and terminal is as short as possible.

It must be ensured that both leads are routed in parallel. They must both be inserted into the hole of the core in the same direction and both leads must have the same number of turns (four turns) (see diagram below).

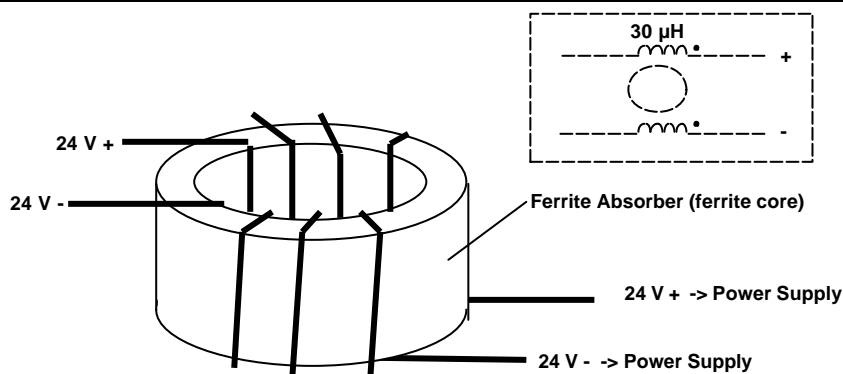
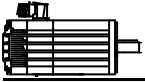
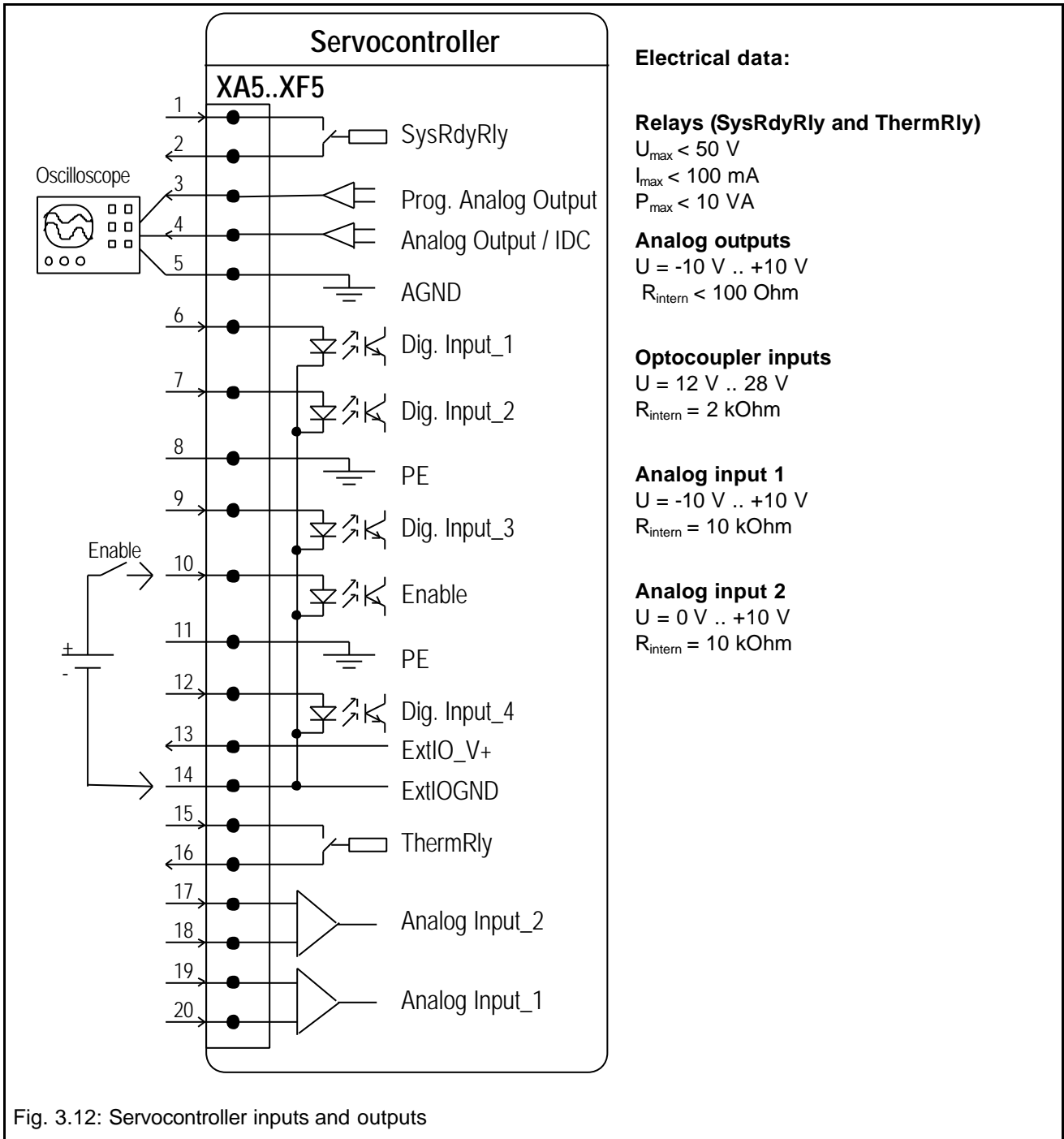

Fig. 3.11: Ferrite core on the 24 V line (signal voltage)



3.9 Wiring the servocontroller inputs and outputs

The inputs and outputs of the servocontroller are illustrated below. Depending on the servocontroller version concerned, the inputs and outputs are activated and evaluated differently by the software. This is described in Chapter "4. Servocontroller T161 ...".





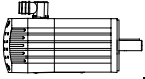

4 Servocontroller T161 CAN Profile Mode

- 4.1 Name plate..... 3**
- 4.2 Functional description 4**
- 4.3 Technical data 4**
 - 4.3.1 Performance data 4
 - 4.3.2 Dimensions and weights 4
- 4.4 Installation and commissioning 5**
 - 4.4.1 Wiring of the inputs and outputs 5
 - 4.4.2 CAN bus..... 6
 - 4.4.3 Setting the MCO Jumper L401 8
 - 4.4.4 Commissioning interface 9
 - 4.4.5 Terminal program MOOGTERM..... 9
 - 4.4.6 Configuration and startup of the servocontroller..... 10
- 4.5 Digital control loop 11**
 - 4.5.1 Block circuit diagram..... 11
 - 4.5.2 List of commands..... 12
- 4.6 Tuning the controller 14**
 - 4.6.1 Integrated function generator..... 14
 - 4.6.2 Analog outputs 15
 - 4.6.3 Tuning the controller 16
- 4.7 Diagnosis 18**
 - 4.7.1 LEDs 18
 - 4.7.2 "System ready" relay..... 18
 - 4.7.3 Sampling fault messages via MOOGTERM 19
- 4.8 Order data 21**

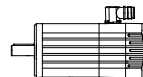

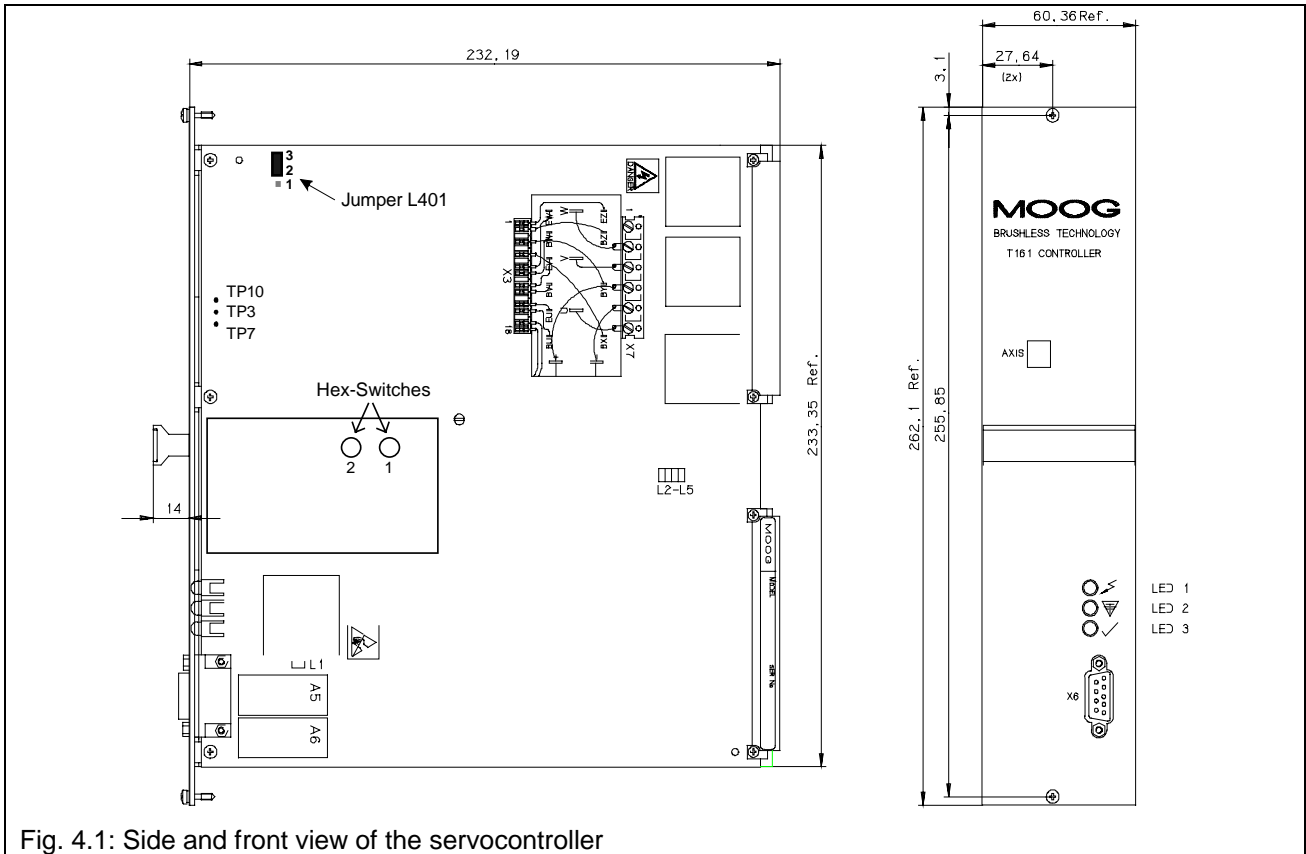
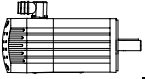

Fig. 4.1: Side and front view of the servocontroller

4.1 Name plate



- x stands for the performance class. This operating instruction applies for all performance classes (from x = 1 to x =4).
- # stands for the revisions index. This operating instruction applies for all revisions.
- SerNo: T0123 stands for the Serial Number. The serial number is incremented with every part produced.



The name plate serves to identify the product.
 For this reason:
 Check whether the name plate on the device matches the name plate illustrated above.

- This documentation must not be used for commissioning and startup if the name plates do not match.
- Devices without name plate are not covered by the manufacturer's warranty and must not be put into operation.

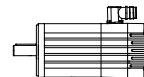

4.2 Functional description

Basic function of the servocontroller

The servocontroller electronically commutates the MOOG brushless servomotors. It closes the speed control loop and delivers a 3-phase sinusoidal motor current which is controlled by a current controller with large bandwidth. The LED status indicator permits rapid diagnosis of faults occurring. Two relay outputs permit evaluation by the host controller.

Higher-ranking functions

The servocontroller is equipped with a CAN interface and motion control commands are sent to the servocontroller via the CAN bus. The servocontroller interprets the commands and executes them. The servocontroller calculates the motion profile and closes the position control loop, thus relieving the control system. This means that even a low-performance control system is able control several axes simultaneously.

The servocontroller returns its actual position, together with comprehensive status information, to the control system via the CAN bus.

4.3 Technical data

4.3.1 Performance data

All current values are peak values:

Model	Peak current ¹⁾	Continuous current with fan ²⁾	Continuous current without fan	PWM frequency	Power dissipation
T161-901	8 A	6 A	3.5 A	10 kHz	13 W + 11 W/A
T161-902	20 A	11 A	4.7 A	10 kHz	13 W + 11 W/A
T161-903	30 A	15 A	6.5 A	5 kHz	13 W + 8,5 W/A
T161-904	60 A	18 A	---	5 kHz	13 W + 8 W/A

¹⁾ Speed > 50 rpm

²⁾ Fan capacity > 35 m³ / h

4.3.2 Dimensions and weights

Model:	T161-901 to T161-903	T161-904
Weight:	2.4 kg	3.5 kg
Installation size (W x D x H in mm):	60.96 x 226.90 x 262.90	91.44 x 226.90 x 262.90

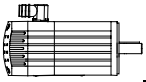

4.4 Installation and commissioning

4.4.1 Wiring of the inputs and outputs



Danger - High voltage on the backplane!

High voltages are present at the backplane, as well as at some screw terminals and the soldering pins. Since accidental contact with the live terminals / soldering pins is always possible when working on the backplane, the system must be disconnected from the mains voltage and secured against inadvertent reconnection by means of the master switch before starting any work on the backplane.

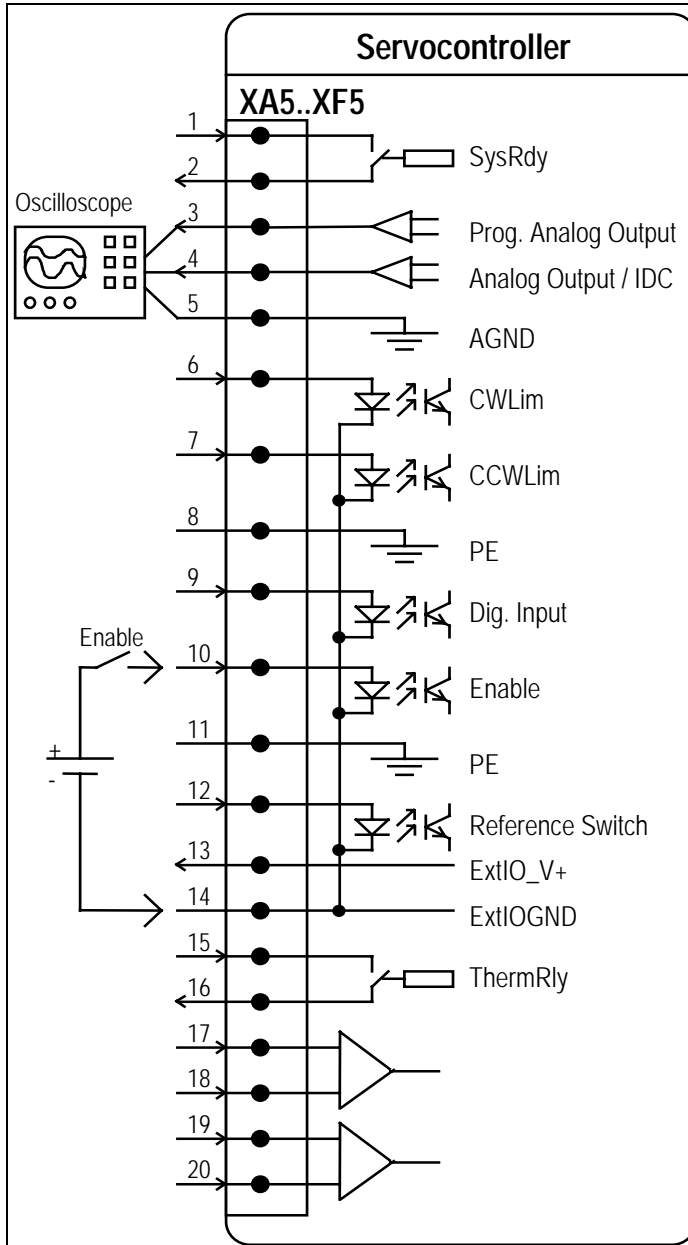

SysRdy - Servocontroller ready relay

The relay contact closes as soon as power is applied to the servocontroller. The contact opens in the case of a fault.

Prog. Analog Output

Programmable analog output (-10 V .. +10 V). The default setting is the actual velocity.

Analog Output / IDC

Second analog output (-10 V .. +10 V). The current and hence the torque is output.

AGND - Reference ground for the analog outputs.

CWLim / CCWLim (limit switch inputs)

A current must flow through the limit switch inputs. The limit switch must have a normally-closed contact.

PE - protective earth conductor

Dig. Input (free digital input)

Enable - hardware enable

In order to accept the software enable the hardware enable must be present.

Home Switch

The home switch must be designed such that it does not simply generate a pulse when the drive passes over it: the switch must remain actuated from the first switching point until the machine reaches the end stop.

ExtIO_V+ - 24 V-take off

If the power supply unit is supplied with external 24 VDC, this voltage can be taken off at this pin.

ExtIO_GND - Reference ground for digital inputs

The digital inputs of the servocontroller are galvanically isolated by optocouplers. All optocouplers use this terminal as their common reference ground.

ThermRly - Thermal limitation relay

This relay contact opens whenever the specified torque cannot be achieved as result of a thermal limitation (overheating of the motor or servocontroller).



Some backplanes do not have screw terminals for connecting the signals. On such backplanes, the signals are wired internally.

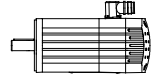

4.4.2 CAN bus

4.4.2.1 Setting the CAN address (= CAN node number)

On each servocontroller there is a small card (the CAN module) plugged onto the main board. This CAN module has two rotary switches SW1 and SW2 the address is set with. Each servocontroller must have its own individual hexadecimal address. Switch SW1 is used to set the lower-order part, switch SW2 for setting the higher-order part of the CAN address.



Checking the CAN address

The command "L-" can be used to display various servocontroller data, including the "Axis ID" (= CAN address). Note that the switch setting "00" corresponds to the Axis ID = 1. The formula is as follows:

$$\text{Axis ID} = \text{setting_of_switch_SW2} * 16 + \text{setting_of_switch_SW1} + 1$$

4.4.2.2 Connector on the backplane

The backplane provides a combined connector X6 for the CAN bus and for an RS 485 interface:

Type: 9-way Sub-D connector, male

Located on: backplane

Pin assignments:

Pin 1:	CAN_High	CAN bus, plus	Input/output
Pin 2:	CAN_Low	CAN bus, minus	Input/output
Pin 3:	RS485+	RS485 serial bus, plus	Input/output
Pin 4:	RS485-	RS485 serial bus, minus	Input/output
Pin 5:	PE	Protective earth	Input/output
Pin 6:	PE	Protective earth	Input/output
Pin 7:	N/C	Not used	
Pin 8:	N/C	Not used	
Pin 9:	N/C	Not used	

In a widely distributed system in an industrial environment, large potential differences may occur locally. These can induce high currents on the data lines and thus disturb the data transmission or even damage the devices connected to the bus. In widely distributed field bus systems it is therefore usual to isolate the individual components galvanically with optocouplers. This stops the current flow and protects the components.

Moog offers a special "CAN isolator" for protection of the servocontroller and the CAN bus. This "CAN isolator" ensures that the CAN bus is galvanically isolated from the servocontrollers.

CAN bus connections over short distances may be done without galvanic isolation.

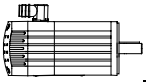

4.4.2.3 Installing the CAN isolator

The CAN isolator is delivered with two standoffs and two screws. After the rack and the backplane have been installed completely, the standoffs are screwed into the backplane (see Fig. 4.3). The CAN isolator is then connected to the Sub-D plug and secured to the standoffs with the two screws.

In order to supply the CAN isolator with power, a wire must be connected from terminal X4 Pin 1 on the CAN isolator board to terminal X5 Pin 8 on the backplane (see Fig. 4.3).

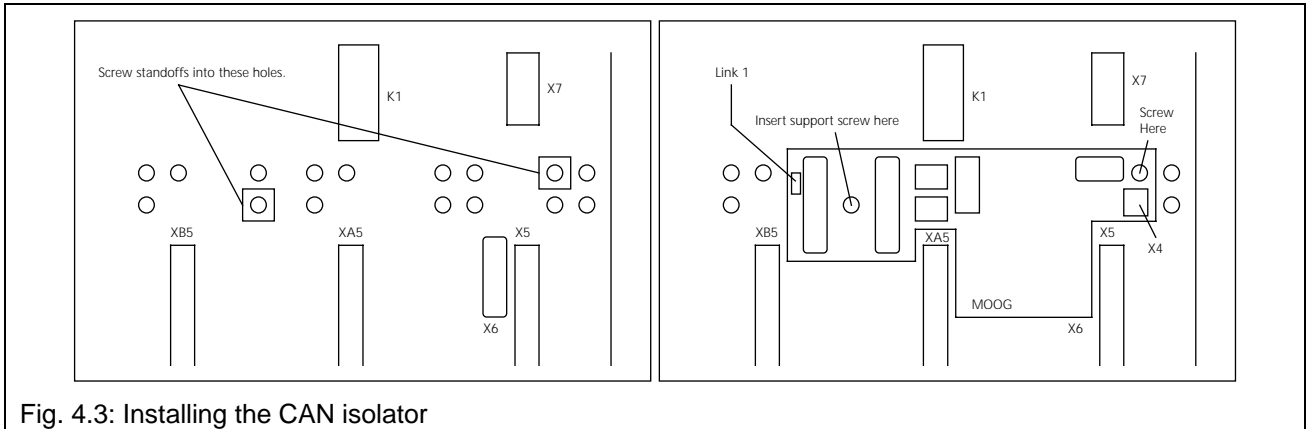

4.4.2.4 Termination resistor

The CAN isolator has one jumper, called Link1.

1. Jumper Link1 must be fitted.
If only one CAN cable is connected to the CAN isolator. In this case, the CAN isolator is the end of the line, and this must be terminated with a termination resistor. The jumper connects the termination resistor into the circuit.
2. Jumper Link1 must be removed.
If two CAN cables are connected to the CAN isolator. This opens the connection to the termination resistor.

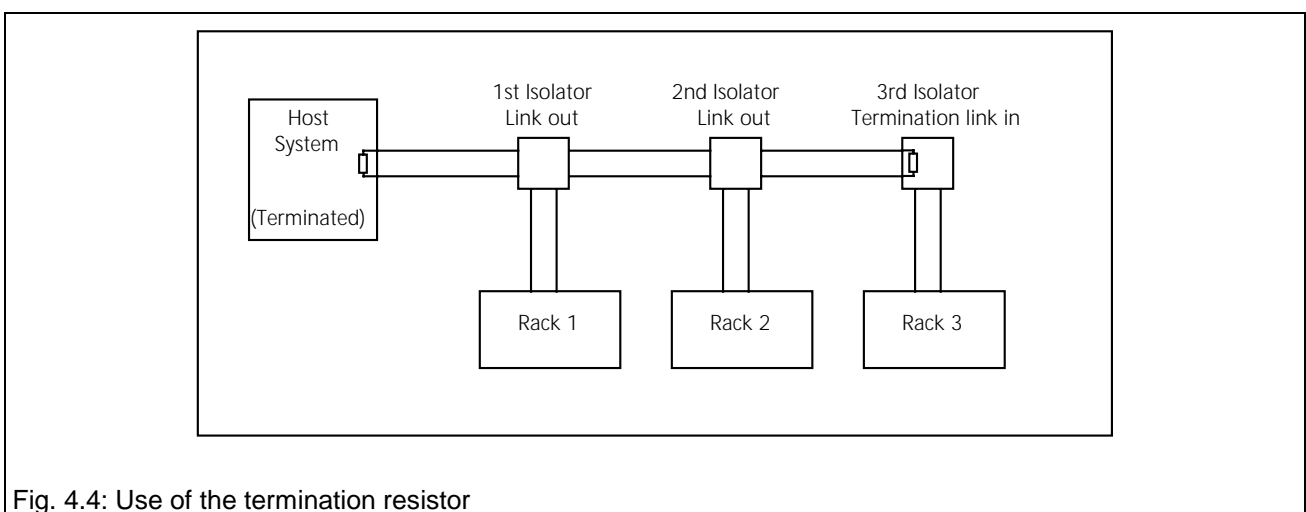

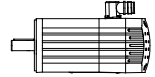

4.4.2.5 Pin assignments of the CAN isolator

The pin assignments on the CAN isolator for the CAN cable comply with the relevant standard:

CAN ISA / DIS 11789

Type: 9-way Sub-D connector, male
 (the female connector is for routing through the CAN cable)
 Located on: CAN isolator

Pin assignments:

Pin 1:		Reserved	
Pin 2:	CAN_Low	CAN bus, minus	Input/output
Pin 3:	Ground	Ground of the CAN cable; do not connect to PE, AGND or DGND of the rack (potential isolation!)	Input/output
Pin 4:		Reserved	
Pin 5:		Reserved	
Pin 6:	Ground	Ground of the CAN cable; do not connect to PE, AGND or DGND of the rack (potential isolation!)	Input/output
Pin 7:	CAN_High	CAN bus, plus	Input/output
Pin 8:		Reserved	
Pin 9:		Reserved	
Case:		Screen	

4.4.3 Setting the MCO Jumper L401

Before the servocontroller is installed in the rack, the MCO jumper L401 must be set to the correct position (see table below).

Motor	T161 - 901		T161 - 902		T161 - 903		T161 - 904	
	Max. current (A)	Jumper position	Max. current	Jumper position	Max. current	Jumper position	Max. current	Jumper position
G422-2xx	2.6	1-2	-	-	-	-	-	-
G422-4xx	5.3	1-2	5.3	1-2	-	-	-	-
G422-6xx	8	2-3	9	2-3	-	-	-	-
G422-8xx	8	2-3	13	2-3	-	-	-	-
G423-2xx	6.5	1-2	6.5	1-2	-	-	-	-
G423-4xx	8	2-3	15	2-3	15	1-2	-	-
G423-6xx	-	-	18	2-3	18	1-2	-	-
G423-8xx	-	-	20	2-3	23	1-2	-	-
G424-2xx	-	-	15	2-3	15	1-2	-	-
G424-4xx	-	-	20	2-3	22	1-2	-	-
G424-6xx	-	-	-	-	30	1-2	-	-
G424-8xx	-	-	-	-	30	2-3	40	1-2
G425-2xx	-	-	-	-	30	2-3	40	1-2
G425-4xx	-	-	-	-	30	2-3	50	1-2
G425-6xx	-	-	-	-	30	2-3	60	1-2
G425-8xx	-	-	-	-	-	-	60	1-2

Status on delivery

- : Not defined at present.

Important: Jumper settings for special motors on request.

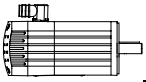

4.4.4 Commisioning interface

The RS232 interface is set as default on the component side of the servocontroller. The RS485 interface can be set by reconnecting jumpers.

Jumper	L2	L3	L4	L5
RS 232 (Default)	Insert	Insert	Remove	Insert
RS 485	Remove	Remove	Insert	Remove

4.4.5 Terminal program MOOGTERM

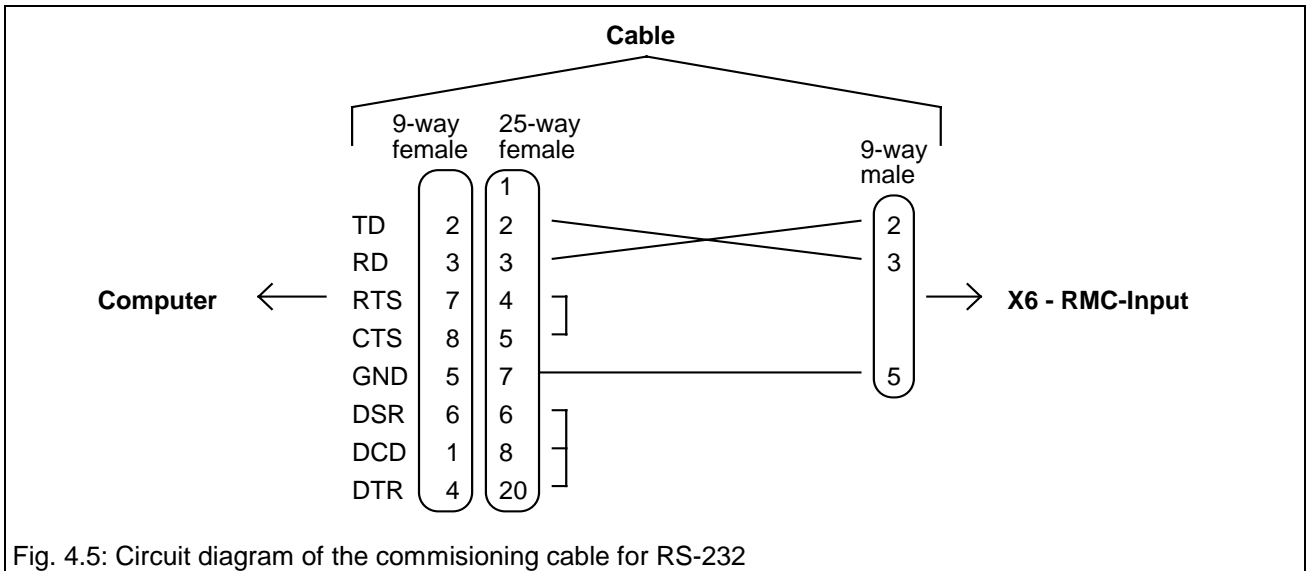

Fig. 4.5: Circuit diagram of the commisioning cable for RS-232

MOOGTERM is a terminal program for commissioning and starting up the servocontroller. MOOGTERM runs on a personal computer under MS-DOS.

MOOGTERM is started by entering its name

```
A:\> MOOGTERM
```

Then the program requests various information:

1. Is MOOGTERM to be configured or not?
The program must be configured when it is started for the first time!
c - Configure
<CR> (Enter) - Continue
2. Which type of interface is to be used?
Press <CR> to select RS232.
3. Which serial interface (COM1 or COM2) is to be used?

The terminal program then starts communication with the servocontroller and determines the software version.

A blue area appears on the left-hand side of the screen. By pressing the Enter key <CR> several times it is checked whether communication is working correctly. The servocontroller responds with the following text:

```
Enter first
letter of a
command or H
for help>
```

or simply with the prompt ">".

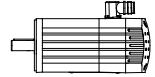

4.4.6 Configuration and startup of the servocontroller

When the entire system has been wired correctly, the system can be switched on. Various LEDs now light on the power supply unit (see Section "Power supply unit - diagnostics"). The red LED on each servocontroller flashes.

The personal computer is connected with the servocontroller via the start up cable. Now the terminal program MOOGTERM can be started.

After pressing the Enter key <CR> several times, the servocontroller outputs the following message:

```
Enter first  
letter of a  
command or H  
for help>
```

or simply the prompt ">".

Enter the motor type

The motor type must now be entered using the command "SM":

```
SM  
Motor:-  
e.g. D314..L10  
G424-400  
G423-200
```

CAN Kommunikation cycle (CAN Communication Period) input

The CAN Communication Period determines the length of a communication cycle. The values for the drive and for the higher ranking control must be the same. Otherwise a communication between the higher ranking control and the drive is not possible.

The command for that is „SC“:

```
SC  
Communication  
Period [mS]  
?  
8
```

Saving the input data

The settings are saved by pressing "C".

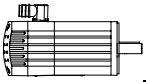

4.5 Digital control loop

4.5.1 Block circuit diagram

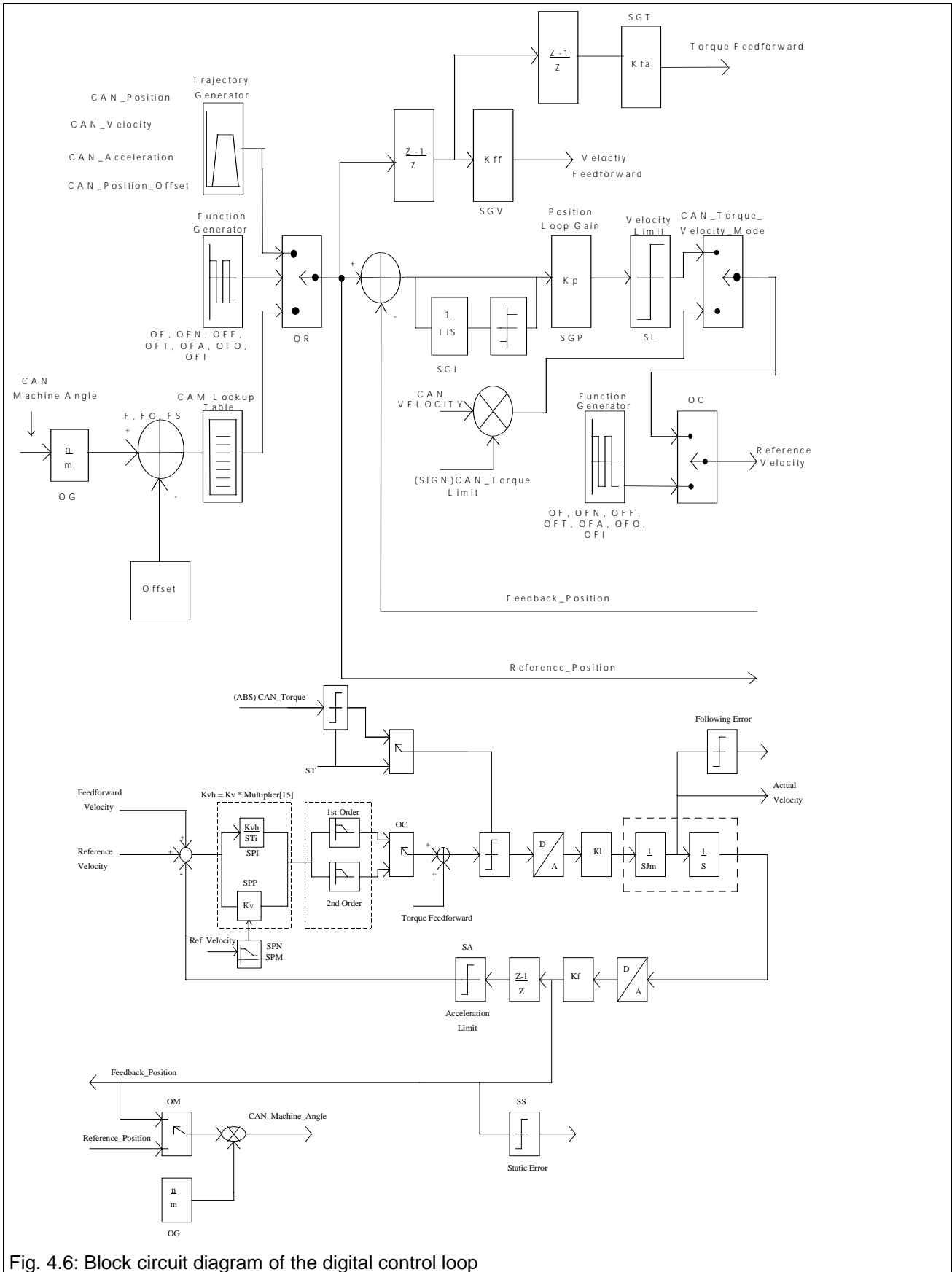
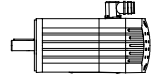

Fig. 4.6: Block circuit diagram of the digital control loop



4.5.2 List of commands

(EPROMs B80861-00# and B80862-00#, # = Revision Index)

		PARAMETER INPUT/OUTPUT
S/L	*	Input/output of all parameters
L	-	Output of system configuration
S	H	Help for parameter input
S/L	L	Input/output of the velocity limit (maximum speed) and of the speed for precise positioning during homing (crawl speed) in [rpm]
S/L	A	Input/output of the filter constant for velocity feedback The filter constant may be changed only by MOOG service engineers!
S/L	E	Input/output of the emergency braking acceleration in [rad/s ²]
S/L	T	Input/output of the torque limit in [Nm]
S/L	PP	Input/output of the proportional gain of the speed loop in [Nm/(rad/s)]
S/L	PI	Input/output of the integral time constant of the speed loop in [s]
S/L	GP	Input/output of the proportional gain of the position loop in [(rad/s)/rad]
S/L	GI	Input/output of the integral time constant of the position loop in [s]
S/L	GV	Input/output of the speed feedforward
S/L	GT	Input/output of the torque feedforward
S/L	S	Input/output of the static following error limit in [u-inc = 1 / 4096 revolution]
S/L	F	Input/output of the dynamic following error limit [percent (greater than 100%)]
S/L	W	Input/output of the cutoff frequency of the torque filter in [Hz]
S/L	Z	Input/output of the attenuation of the torque filter
S/L	PN	Input/output of the two cutoff speeds for reduced gain in the upper speed range in [rpm]
S/L	PM	Input/output of the table for reduced gain in the upper speed range
S/L	M	Input/output of the motor type and the motor parameters The motor type can be entered only with software version -002 or higher. With older versions, the controller must be re-initialized.
S/L	C	Input/output of the CAN communication cycle period in [ms] The CAN communication cycle period can be entered only with software version -002 or higher. With older versions, the controller must be re-initialized.

		SPECIAL COMMANDS
C		Save parameters permanently in EEPROM
Control X		Software warmstart
Control T		Upload or download the system parameters to/from a binary file.
<F1>		Upload the data to a file. This file can be printed out. It is not possible to download this file. The filename may not contain special characters or an extension. This function is available only with MOOGTERM 5.0 or higher.

		HELP FUNCTION
H		Help as help function
+		Top help level
-		Reduced help level The help function is no longer supported in newer versions. The startup program MOOGTERM 5.0 now contains the help texts.

		STATUS POLLS
?H		Help for this block
?M		Motor temperature in [°C]
?B		Temperature of the power output stage in [°C]
?P		Rotor position (motor shaft position) [0° .. 360°]
?V		Average speed in [rpm]
?L		Current limitation (limit settings) in [A]
?F		General fault messages
?C		CAN-specific fault messages

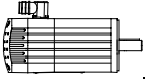

		COMMANDS IN TEST MODE
T	Switch to test mode In test mode, the CAN bus is ignored and commands can be entered via the terminal. The following commands work only after switching to test mode. In test mode, the following prompt is displayed: T>	
Q	Quit test mode	
H	Help for test mode	
I	Input of the necessary parameters for the speed curve (maximum speed and maximum acceleration, reference speed in percent of maximum speed, reference acceleration in percent of maximum acceleration)	
MB	Apply or release brake	
MI	Enable motor	
MO	Disable motor	
P	Positioning of axis (point-to-point, absolute or relative)	
?	Display all position information	
J	Jog mode: axis rotates at constant speed (stop with command "E")	
E	Stop motion (caution: this command must be entered several times before the drive stops).	
A	Input of the acceleration as a percentage of the maximum value	
V	Input of the speed as a percentage of the maximum value	
O	Offset command (for CAN communication)	

		OPTIONAL COMMANDS
OH	Help for this block	
OC	Input of the control loop structure	
	1 Velocity mode (setpoint from function generator)	
	2 Position mode (setpoint from CAN or function generator) followed by input of the torque filter:	
	1 First-order filter	
	2 Second-order filter	
OR	Selection of the setpoint source	
	1 CAN bus	
	2 Implemented function generator	
OL	Activate/deactivate hardware limit-switch inputs and program software limit switches	
OS	Program signal level for the reference switch (high or low active)	
OF	Set up function generator	
	N Input of function generator speed (amplitude) in [RPM]	
	A Input of acceleration in [rad/s ²]	
	T Input of traverse distance in [revs.]	
	F Input of repetition frequency in [Hz]	
	O Switch off function generator (drive remains enabled)	
	I Switch on function generator After the function generators has been set up:	
	MB releases the brake and	
	MI enables the drive.	
	MO disables the drive.	
OT	Programmable analog output, available at TP10 and Xμ5, Pin 3 (voltage range: +/-10 V)	
	H Help for these commands	
	1 IDC (current monitor, corresponding to a DC motor)	
	2 Reference velocity (first define velocity-> voltage scaling with "SN")	
	3 Actual velocity	
	4 Velocity deviation	
	5 Position setpoint (first define revolutions -> voltage scaling with "SR")	
	6 Actual position	
	7 Position deviation (following error)	
	0 Offset adjustment of the current position to 0 V	
OO	Change resolver home angle (Program the resolver zero position as an offset from its mechanical zero point)	

		PROGRAMMING THE GEARBOX FUNCTIONS
OG	Input of gearbox ratio (n/m) for Master or Slave drive	
OM	Master is to send its actual or setpoint position (feedback or reference) to the slaves	
F	Open CAM Table menu	
	H Help for CAM Table menu	
	E Edit CAM Table	
	B Enter CAM Table limit (this limit value defines one revolution of the slave at a CAM amplitude of 1000hex)	
	S Save CAM Table permanently in EEPROM	
	Q Quit CAM Table menu	

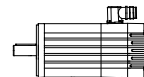

4.6 Tuning the controller



Beware of mechanical hazards!

Servomotors can accelerate highly dynamically. They also have an enormous torque. The following points must therefore be observed when commissioning the system:

- **The danger zone around the motor must be cordoned off.**
The system must feature a guard door preventing personnel from reaching into or entering the danger zone. If the guard door is opened, the drive system must be disconnected from the supply voltage immediately. This is best done by de-energizing the contactor inserted before the MOOG power supply unit.
- **The control parameters determine the dynamic and static behaviour of the servomotor.**
Incorrectly or wrongly set parameters can cause the servomotor to run at an excessive speed (instable controller settings).
- If the drive is moved with the aid of the function generator, it should be noted that the motor speed and the repetition frequency are used to determine for how long and how far the motor rotates in one direction. This must be noted if the machine is equipped with mechanical end stops.

The integrated function generator and the (programmable) analog outputs (X#5 Pin 3 and Pin 4) are used to tune the controller.

4.6.1 Integrated function generator

The servocontroller features an integrated function generator which can be used to tune the controller by means of the step response. Speed and position setpoints can be generated and fed into the corresponding control loop. The function generator can be selected as compensator reference with the command "OR".

OFI to enable the function generator.

OFO to disable the function generator
(The motor remains enabled).

The function generator must be disabled before any function generator parameters can be changed.

4.6.1.1 Generation of a reference velocity curve

The function generator provides a square-wave oscillation with programmable frequency and amplitude for generation of a reference velocity curve.

OFN to enter the amplitude of the reference velocity (max. speed), unit: rpm.

OFF to enter the frequency of the square-wave oscillation, unit: Hz.

Note that the required speed and the frequency of the square-wave oscillation determine how fast and for how long the drive runs in any one direction. The values must be selected in such a way as to prevent the drive from running against the limit stops of the machine.

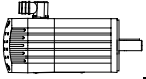

4.6.1.2 Generation of a reference position curve

The reference position curve output of the function generator includes a trapezoidal velocity curve. The maximum permitted acceleration and maximum permitted speed must be specified, as well as the traverse amplitude and tuning frequency. The motor then follows the square position profile with limited acceleration and speed.

- OFT to enter the traverse amplitude (unit: revolutions).
- OFN to enter the maximum speed (unit: rpm).
- OFA to enter the maximum acceleration (unit: rad/s²).
- OFF to enter the tuning frequency (unit: Hz).

It is possible that the maximum speed cannot be reached or that the tuning frequency cannot be maintained with the specified traverse amplitude and specified acceleration. In such cases, the specified acceleration and specified traverse amplitude have priority.

4.6.2 Analog outputs

The servocontroller has two analog outputs for the output of dynamic control process variables to an oscilloscope. The outputs are accessible on both the backplane and the front panel. They are covered by the black Lexan foil on the front panel. It is possible to either cut a hole into the foil or - better - the foil can be peeled off carefully so that it can be resecured subsequently. The free programmable output is programmed via the command "OT...".

Output	TP10 or X#5, Pin 3
Position offset adjustment (the actual position corresponds to a voltage of 0 V after compensation)	OTA0
Current I _{dc} , (is proportional to the torque)	OT1
Reference speed	OT2
Actual speed	OT3 *)
Position setpoint	OT4
Actual position	OT5
Position error (following error)	OT6

*) Default setting after switching on the servocontroller (again).



Scaling

- **Speed**
The speed is scaled via the command "SN" (10 V correspond to ... rpm?)
- **Position** (for regarding the following error)
The position is scaled via the command "SR" (10 V correspond to ... revolutions?).

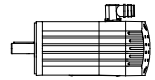

4.6.3 Tuning the controller

This section describes how the controllers can be set by means of a step response. A different method must be used if this is not permitted by the machine.

The velocity control loop must be tuned first, followed by the position control loop.

Saturation must be avoided when tuning the controller. Otherwise it would not work in the linear range anymore. Therefore the current must be observed (via the analog outputs) in order to ensure that it is not limited.

4.6.3.1 Tuning the velocity control loop

In order to tune the velocity loop, the drive must be set to speed mode and the function generator selected as compensator reference.

OR to select the function generator as compensator reference.

Then the following inputs are requested:

- Traverse (traverse distance in revs.): enter "0".
- Tuning Acceleration (in Nm/(rad/s)): enter "50 000".
- Tuning Max. Speed (speed amplitude in rpm): enter speed.
- Tuning Frequency (in Hz): enter the tuning frequency

OC to switch to velocity mode.

MO to disable the motor.

MB to engage the brake.

OFN to enter the function generator speed (tuning maximum speed in rpm).

OFF to enter the frequency of the square-wave oscillation (in Hz).

SPP to enter the proportional gain of the velocity control loop (in Nm/(rad/s)).
A low value should always be entered first and then gradually increased!

SPI to enter the integral time constant of the velocity control loop (in s).
The maximum value has to be entered (3 s)!

OT to program the analog output.
OT3 for output of the actual velocity.

OFI to enable the function generator.

MI to enable the motor and release the brake.

The reference speed and actual speed are illustrated in Fig. 4.7.

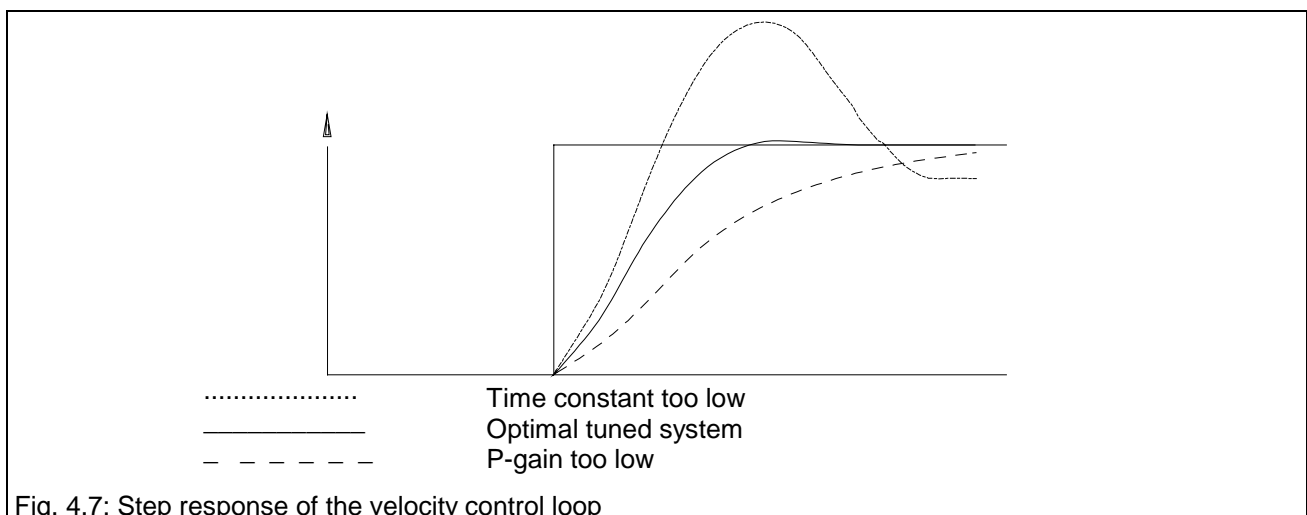
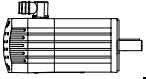

Fig. 4.7: Step response of the velocity control loop



The controller should be tuned as shown in Fig. 4.7. Overshoots occur if the proportional gain of the controller is too high. The system slows down if the gain is too low.

The integral component of the control loop increases its stiffness against interferences due to the load torque and prevents a speed offset. The disadvantage of this is, however, that the integral component has a negative effect on the stability of the control loop.

4.6.3.2 Tuning the position control loop

The position control loop is set in the same way as the speed control loop.

- MO to disable the motor.
- MB to engage the brake.
- OR to select the function generator as compensator reference.
- OC to switch to position mode.
- OFT to enter the traverse amplitude of the function generator.
- OFN to enter the maximum permitted reference speed (tuning maximum speed) for the function generator.
- OFA to enter the maximum permitted acceleration of the function generator.
- OFF to enter the frequency of the square-wave oscillation.
- SGP to enter the proportional gain of the position control loop.
A low value should always be entered at first!
- OT to program the analog output.
OT0 to perform a position offset adjustment.
OT4 for output of the reference position.
OT5 for output of the actual position.
- OFI to enable the function generator.
- MI to enable the motor and release the brake.

Users are referred to appropriate textbooks for optimization.



Do not forget to save

After tuning the controllers, the controller parameters should be saved to EEPROM (command: "C"). Before saving, however, the servocontroller set back to the correct control mode (position control), and the correct compensator reference should be selected (CAN bus), since the actual control mode and actual compensator reference are also saved in the EEPROM.

- OC Switch to position control
- OR Switch to CAN as compensator reference
- C Save tunings
The servocontroller requires the input of a 4-digit code number. The code number can be selected at random, e.g. 1234.

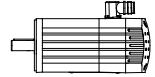

4.7 Diagnosis

4.7.1 LEDs

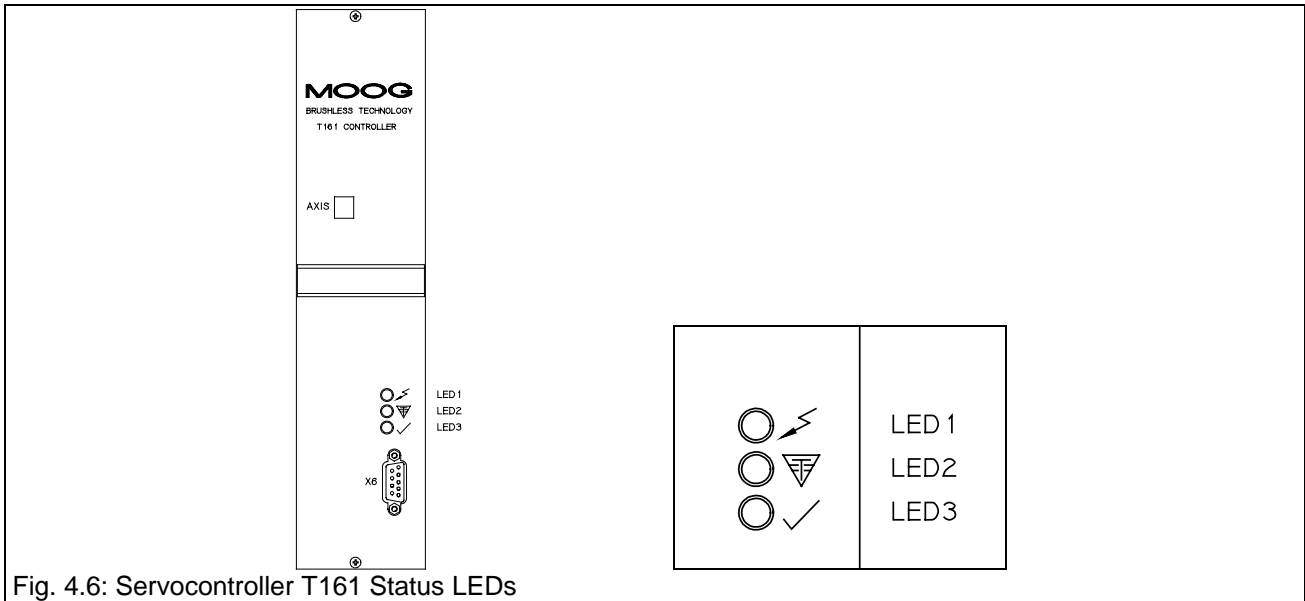

Fig. 4.6: Servocontroller T161 Status LEDs

Status LEDs:

LED 1 (red) LED flashes

Servocontroller is booting (reads out parameters from the memory for configuration). The LED lights up red (stops flashing) when the servocontroller has completed booting.

The LED continues to flash if the servocontroller has never been configured previously. In this case, the servocontroller must be configured via the serial port (enter the motor type, etc.).

The LED lights up if a fault occurs.

If the servocontroller has been enabled and a fault occurs, the green LED 3 goes out and the red LED 1 lights up again.

The saved faults are deleted and LED 1 goes out when the servocontroller is re-enabled.

LED 2 (yellow) Torque limitation active due to thermal overload

As long as the torque limitation is active, the contact of the thermal limit relay (X#5 / Pins 15 and 16) remains open and this LED lights.

LED 3 (green) Enable

As soon as the servocontroller is enabled this LED lights up.

It is switched off when the servocontroller is disabled.

LED 3 is switched off as well in the case of a fault (red LED 1 lights).

4.7.2 "System ready" relay

Relay status	Condition
Relay contact remains open	- When the servocontroller is switched off completely.
Relay contact closes	- When the servocontroller is switched on and no fault is present. (The high voltage need not be present.) - When the servocontroller is re-enabled after a fault, thus resetting the fault.
Relay contact opens	- When the servocontroller is switched off. - When a fault occurs while the motor is enabled.

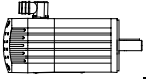

4.7.3 Sampling fault messages via MOOGTERM

MOOGTERM is the startup and commissioning program for servocontrollers and runs on an MS-DOS personal computer. The program is described elsewhere in this chapter.

The fault memory of the servocontroller can be sampled via the command "?F". There are two types of fault messages:

Fault text	Meaning
... Fault occurred	A fault has occurred and the fault message has been saved. The fault message is saved until sampled and deleted afterwards. The fault message is not redisplayed when sampled again, unless the fault has recurred. Note that numerous faults may occur when booting the servocontroller. These fault messages are saved until sampled. Such "old" fault messages can be deleted by sampling and thus clearing the fault memory immediately after booting the servocontroller.
... Fault present	A fault has occurred and is still present.



Danger - high voltage!

The servo drives operate with potentially lethal voltages.

For this reason:

- **Disconnect the system from the mains supply.**
Before starting any work on the drive system, it must be disconnected from the power supply and secured against inadvertent reconnection by means of the master switch.
- **The servomotors must come to a complete stop.**
Rotating servomotors can generate potentially lethal voltages by acting as generators.



Beware of charged capacitors!

The capacitors in the power supply may still be charged.

For this reason:

- **Note the discharge time of the capacitors.**
The power supply contains capacitors which may be charged with up to 400 VDC. Wait at least 5 minutes for the capacitors to become discharged after disconnecting the voltage.
- **The voltage must then be measured between DC+ (X7/1) and DC- (X7/2).**
Work on the power supply must not start until the voltage has dropped below 5 V.

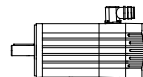

Fault message	Meaning and remedial action
Bridge Temperature Fault	The power output stage of the servocontroller has overheated. The motor is disabled by the servocontroller. Remedy: Wait until the power output stage has cooled. Check fan. If the fault occurs regularly, the servocontroller is overloaded. Either the servocontroller is wrongly dimensioned (too small) or a mechanical fault has occurred (drive elements stick and prevent movement).
Motor Temperature Fault	The servomotor has overheated. The motor is disabled by the servocontroller. Remedy: Wait until the servomotor has cooled. If the fault occurs regularly, the servomotor is overloaded. Either the servomotor is wrongly dimensioned (too small) or a mechanical fault has occurred (drive elements stick and prevent movement).
Resolver Fault	Fault in resolver evaluation. Check wiring of motor signal cable: <ul style="list-style-type: none"> • Is signal connector plugged into correct port on backplane? • Is signal connector correctly screwed onto motor? • Disconnect signal cable from backplane and motor and check conductors for electrical continuity. Refer to the circuit drawing in the chapter on Installation. The following must additionally be checked when using self-made cables: <ul style="list-style-type: none"> • Refer to the circuit drawing in the chapter on Installation. • Have the signal leads been twisted in pairs? • Is the cable shielded and the shield connected at both ends? • Is the cable made up of a single length and not connected via a terminal box?
CAN Bus Fault	CAN communication between the servocontroller and control system has been interfered. Remedy: <ul style="list-style-type: none"> • Check CAN cable. • Check that the CAN cable has been terminated with 120 Ohm at both ends.
Bus Overvoltage Fault	An overvoltage has occurred in the DC bus. Remedy: <ul style="list-style-type: none"> • Switch off high voltage for power supply unit T160-9xx and switch on again after 5 seconds. This fault is occurs if the power supply unit cannot dissipate the energy fed back by the servomotors in braking mode, thus causing the bus voltage to increase.
Bridge Short Circuit Fault	Short-circuit fault in motor or motor power cable or servocontroller. Check wiring of motor power cable: <ul style="list-style-type: none"> • Have phases (phase sequence important!), PE and shield been connected correctly? • Disconnect power cable from backplane and motor and check conductors for short-circuits. Refer to the circuit drawing in the chapter on Installation. Check motor: <ul style="list-style-type: none"> • Unscrew power cable. • Measure resistance between individual motor phases U-V, U-W and V-W. The resistance values must be roughly identical and correspond with those specified in the motor catalogue. If any of the values differs significantly, then a short-circuit or wire break has occurred in the motor. Call MOOG.
Analog Power Supply Fault	Fault in the +5 V or ±15 V supply. Voltages are led to the backplane and can be measured with a voltmeter. <ul style="list-style-type: none"> • If the voltages are within the tolerance range (5 V±0.5 V; ±15 V±1 V), the system must be completely disconnected from the power supply and switched on again after 5 seconds. • If the voltages are outside the tolerance range, individual servocontrollers must be withdrawn (Only after switching off the mains!) to determine whether a short-circuit has occurred in a servocontroller or whether the power supply unit is defective.

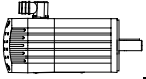

4.8 Order data

No.	Description	MOOG Order No.
1	Servocontroller, 8 Amps	T161 - 901 # - 10 - G# - 2 -1#
2	Servocontroller, 20 Amps	T161 - 902 # - 10 - G# - 2 -1#
3	Servocontroller, 30 Amps	T161 - 903 # - 10 - G# - 2 -1#
4	Servocontroller, 60 Amps	T161 - 904 # - 10 - G# - 2 -1#
5	Commissioning software MOOGLTERM (for IBM-compatible PCs) 3.5" floppy disk 5.25" floppy disk	B47214-001 B47214-002
6	Commissioning cable for PC (5 metres)	B48424-105
7	Hand-held control unit (without cable)	B48426-002
8	Cable for hand-held control unit (5 metres)	B48423-003

= Revision index for hardware, software and optical design (from left to right)

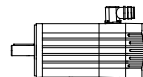

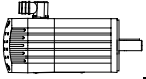

5 Power supply unit T160-9xx

5.1 Name plate	3
5.2 Functional description	4
5.3 Technical data	5
5.3.1 Power connection	5
5.3.2 24 VDC input (optional).....	6
5.3.3 Power output.....	6
5.3.4 Power of the ballast circuit	7
5.3.5 Dimensions and weights	7
5.4 Diagnosis	8
5.4.1 LEDs	8
5.4.2 Relay "Power supply unit OK"	9
5.5 Scope of delivery	9
5.6 Order data	10

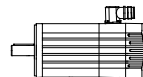

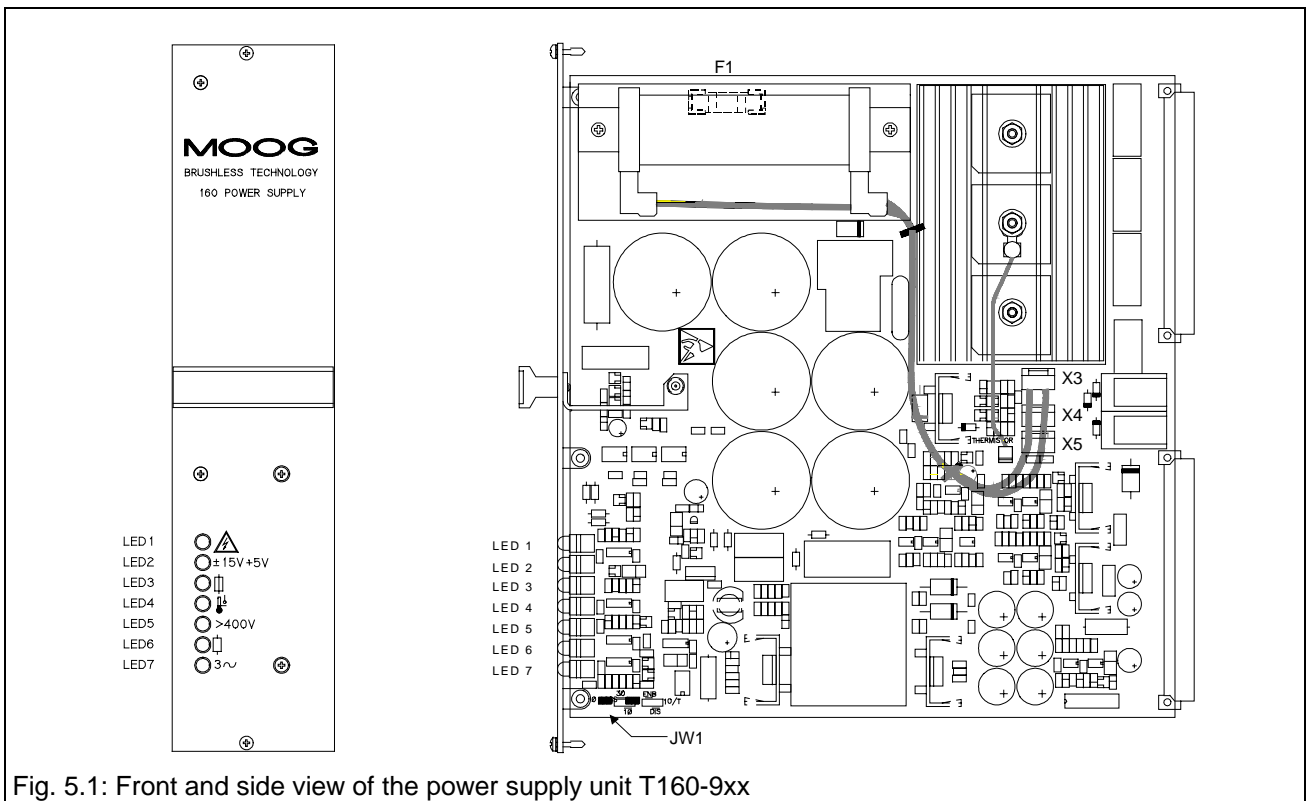
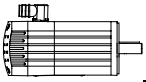

Fig. 5.1: Front and side view of the power supply unit T160-9xx

5.1 Name plate



stands for the revisions index.
This operating instruction applies for all revisions.

SerNo: T0123 stands for the serial number.
The serial number is incremented with every part produced.



The name plate identifies the product.
For this reason:

- Check whether the name plate on the device matches the name plate illustrated above.
- This documentation must not be used for commissioning and startup if the name plates do not match.
- Devices without name plate are not covered by the manufacturer's warranty and must not be put into operation.

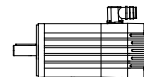

5.2 Functional description

The power supply unit has two functions:

1. Power supply for the servocontroller

The power supply unit generates the voltages required by the servocontroller:

- DC bus voltage (nominal value 325 VDC)
The servocontroller takes its energy from a DC bus buffered by capacitors. This DC voltage is generated by the power supply unit by rectifying the AC voltage (nominal value 230 VAC).
- +5 V
The servocontroller includes a microcomputer requiring a +5 V supply.
- ± 15 V
The servocontroller also includes analog circuits requiring a power supply of ± 15 V.

2. Ballast circuit

The power supply unit regulates the DC bus voltage. The DC bus capacitors are charged when the servomotors feed back energy into the power supply unit in generator mode, thus increasing the DC bus voltage. By means of the ballast circuit, the capacitors are partially discharged via the ballast resistor until the nominal DC bus voltage is adjusted again.

Different types of power supply units

The power supply units can primarily be classified in two groups:

1. Power supplies with external 24 VDC supply

For these power supply units 24 VDC must be supplied externally. The +5 V and ± 15 V supplies are generated from these 24 VDC. This ensures that the microcomputer, the position feedback evaluation and an optional CAN bus remain fully functional if the power must be disconnected for operational reasons, e.g. following an Emergency SWITCH OFF.

2. Power supplies without external 24 VDC supply

An external 24 VDC supply is not required for these power supply units. The microcomputer, the position feedback evaluation and an optional CAN bus stop their operation when the power is disconnected. If necessary, homing cycle must be performed after switching the power on again.

The power supply units also differ with regard to the power dissipation of their ballast circuits.



Warning:

Correct dimensioning of the ballast circuit is particularly important in conjunction with the following applications:

- **Lifting axis**
If the lifting axis does not have a self-locking gear, the servomotor must brake when the load is lowered. The servomotor operates in generator mode in this case. The energy fed back must be converted into heat via the ballast circuit. It is therefore important to ensure that the ballast circuit is dimensioned correctly and can dissipate the energy.
- **Rapid deceleration of large masses**
Considerable amounts of energy must be dissipated by the ballast circuit as well when large masses are rapidly decelerated from high speeds. It should be noted that the shorter the braking time, the higher becomes the required peak braking power (energy per time unit). The ballast circuit must be dimensioned to dissipate not only the required continuous power, but also the peak power.

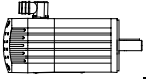

5.3 Technical data

5.3.1 Power connection

The power supply unit can be operated either with a one-phase or three-phase AC voltage:

	Minimum	Nominal	Maximum
Supply voltage	207 VAC	230 VAC	254 VAC
Mains frequency	44 Hz	50 Hz	66 Hz
Fuse		16 A slow-blow *)	

*) For 3-phase operation, a 3-phase automatic circuit-breaker must be used in order to ensure that all phases are tripped at the same time in the event of a fault!



Important: Isolating transformer required

The isolating transformer is required in order to maintain the specified isolation (creepage distances and clearances) in relation to unprotected small-signal auxiliary voltages. The isolating transformer must conform to standard EN 60204-1. The protective earth conductor must be connected.

If **other precautions** are taken,

- the power supply unit can be connected directly to the mains supply for one-phase operation,
- an autotransformer can be used to adjust the voltage for three-phase operation.

One-phase operation:

In one-phase operation, the voltage between live and neutral is 230 VAC. An isolating transformer with 1:1 transformation ratio must be used. The secondary terminals of the isolating transformer are connected to terminal X3-pin 2 and X3-pin 3. The protective earth conductor must also be connected.

Three-phase operation:

The nominal voltage between the power supply unit terminals must be equal to 230 VAC. The phase-to-phase voltage of a normal 3x400 VAC 3-phase mains supply must be stepped down to 3x230 VAC by means of an isolating transformer connected to terminal X3. The protective earth conductor must be connected.



Note:

Leakage currents flow on the PE conductor if no isolating transformer is used.

The leakage current may exceed 3.5 mA under corresponding operating conditions. It is therefore recommended to connect an additional PE conductor of at least 10 mm² to the rack (see VDE 0160).

The leakage currents are drastically reduced when using an isolating transformer.

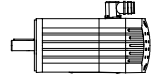

5.3.2 24 VDC input (optional)

The type of power supply unit used determines whether a 24 VDC power supply is required or not.

Power supply T160 - 901 # - 00 - 1# 24 VDC not required

Power supply T160 - 902 # - 00 - 1# 24 VDC required

Power supply T160 - 932 # - 00 - 1# 24 VDC required

	Minimum	Nominal	Maximum
24 VDC input	20 VDC	24 VDC	35 VDC
Power consumption		20 W plus 25 W per servocontroller	
Recommended fuse		10 Amps, slow-blow	

A 3-phase rectifier is sufficient. It is not necessary to smooth the voltage.

The 24 VDC power supply unit should be capable of delivering a short overload switch-on current.



Important: A 24 V power supply with reliable insulation must be used!

The power supply providing the 24 VDC for the MOOG power supply unit must have a reliable insulation to the mains voltage and must conform to standard EN 60950.

5.3.3 Power output

The power supply unit supplies the servocontroller with power in the form of a DC voltage buffered by capacitors.

	Minimum	Nominal	Maximum
DC bus voltage (no-load operation)	292 VDC	325 VDC	359 VDC

Power:	Continuous power	Short-time for 3 sec	Short-time for 1 sec
3-phase operation with fan	7.5 kW	10.0 kW	15.0 kW
1-phase operation with fan	2.5 kW	3.7 kW	5.0 kW
3-phase operation without fan	2.5 kW	5.0 kW	8.0 kW
1-phase operation without fan	0.8 kW	1.2 kW	1.6 kW



Warning:

A fan is required if more than four servocontrollers are installed.

Then the fans must be switched on as soon as voltage is applied the power supply. If the power supply requires an external 24 VDC supply, the fan must be switched on as soon as the 24 VDC supply is connected.

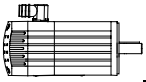

5.3.4 Power of the ballast circuit

Power supply unit	External ballast resistor	Continuous ballast power	Peak ballast power
T160-901# -00-1# or T160-902# -00-1#	None	40 W	2,800 W for 100 ms
	50 Ohm, 225 Watt	200 W	2,800 W for 300 ms
	10 Ohm, 350 Watt	235 W	16,900 W for 100 ms
T160-932# -00-1#	10 Ohm	900 W	14,000 W for 160 ms

Maximum permissible DC bus voltage: 400 VDC
 Nominal DC bus voltage: 325 VDC
 Capacitance in the DC bus: 2,800 µF
 Switch on voltage for ballast resistor: 380 VDC ± 5 %
 Switch off (again) voltage for ballast resistor: 373 VDC ± 5 %

5.3.5 Dimensions and weights

Model:	T160-901# -00-1# T160-902# -00-1#	T160-932# -00-1#
Weight:	1.9 kg	1.9 kg
Installation size (W x D x H in mm):	60.96 x 226.90 x 262.90	60.96 x 226.90 x 262.90

Ballast resistor

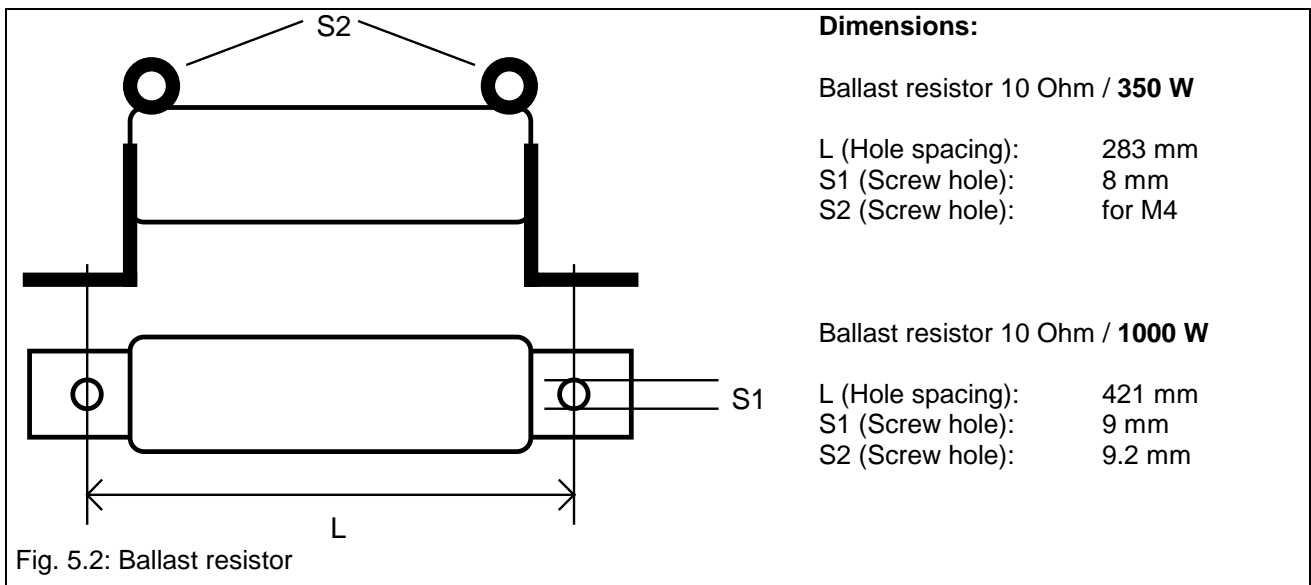

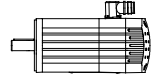

5.4 Diagnosis

5.4.1 LEDs

<p>LED 1</p> <p>LED 2</p> <p>LED 3</p> <p>LED 4</p> <p>LED 5</p> <p>LED 6</p> <p>LED 7</p>		<p>LED 1 DC bus voltage ready (green) This LED lights up as soon as the power (230 VAC) is present. This LED must light during operation. The LED slowly goes out when the power is switched off.</p> <p>LED 2 ±15 VDC, +5 VDC ready (green) This LED lights up as soon as the ±15 VDC and +5 VDC are present within their tolerances. This LED must light during operation.</p> <p>LED 3 Braking resistor fuse defective (red) The fuse for the ballast resistor is defective and must be replaced.</p> <p>LED 4 Power supply overtemperature (red) The power supply unit has overheated. It is being overloaded by the application, or a fault has occurred which has imposed an additional load on the power supply unit.</p> <p>LED 5 DC bus voltage >400 VDC (red) During braking the load, the motors have fed back too much power in generator mode. The ballast resistor of the power supply unit has been overloaded.</p> <p>LED 6 Ballast resistor active (yellow) This LED may light up shortly when the servomotors feed back power in generator mode. The ballast resistor is connected as long as the LED remains alight. The LED lights up when the high voltage is disconnected thus indicating that the DC bus circuit is being discharged via the ballast resistor.</p> <p>LED 7 Loss of phase (red) One of the phases has failed in 3-phase operation. This fault is also indicated if the power supply unit is configured for 3-phase operation but operated from only one phase.</p>
--	--	---

LED 3, 4, 5, 7:	When a fault occurs the relay "Power supply unit OK" (X5/Pin 5/6) opens. The only fault latched is bus overvoltage (LED 5). This has to be reset.
LED 3, 4, 5:	When a fault occurs, a fault signal is generated in all servocontrollers. The servocontrollers cannot be reenabled in as long as the fault is present.

5.4.1.1 Resetting the bus overvoltage fault message (LED 5)

Power supply 160-901	Switch off power supply unit. Wait 5 seconds and switch on again.
Power supply 160-902 and T160-932	Switch off the mains supply (230 VAC) of the power supply unit. The external 24 VDC supply does not have to be switched off. Wait 5 seconds and switch on again.

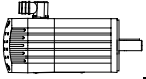

5.4.2 Relay "Power supply unit OK"

Relay status	Condition
Relay remains open	When power supply unit is switched off completely. When only 24 VDC are applied to the power supply unit. During softstart.
Relay contact closes	When there is no fault present AND the softstart sequence is finished.
Relay contact breaks	When the mains voltage is disconnected. When one phase fails in 3-phase operation. When the 24 VDC supply voltage fails. When the +5 V generated by the power supply unit fails (required for the relay). When an overvoltage occurs on the DC bus.

5.5 Scope of delivery

The scope of delivery must be checked to ensure that the correct power supply unit has been ordered and delivered.

T160 - 901 # - 00 - 1# and T160 - 902 # - 00 - 1#	The scope of delivery includes the following parts for these power supply units:
	<ul style="list-style-type: none"> - The power supply unit as such - One 1.6 A fuse installed in the power supply - One 2.5 A fuse - One 8 A fuse - One instruction leaflet
T160 - 932 # - 00 - 1#	The scope of delivery includes the following parts for this power supply unit
	<ul style="list-style-type: none"> - The power supply unit as such - One 10 A fuse installed in the power supply <p>The ballast resistor required for operation is not included in the scope of supply and must be ordered separately.</p>

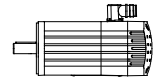

5.6 Order data

No.	Description	MOOG Order No.
1	Power supply unit, no external 24 V supply Ballast circuit 40 W/2800 W	T160 - 901 # - 00 - 1#
2	Power supply unit with external 24 V supply Ballast circuit 40 W/2800 W	T160 - 902 # - 00 - 1#
3	Ballast resistor 10 Ohm/350 W	A76178-002
4	Spare fuse F1, Siba 1.6 A/415 V/slow-blow	B94138-001-600
5	Spare fuse F1, Siba 2.5 A/415 V/slow-blow	B94138-002-500
6	Spare fuse F1, Siba 8 A/415 V/slow-blow	B94138-008-000
7	Ballast resistor 50 Ohm/200 W as replacement part in existing systems	A76178-001
8	Power supply unit, with external 24 V supply Ballast circuit 900 W/14000 W (Order ballast resistor together with power supply unit!)	T160 - 932 # - 00 - 1#
9	Ballast resistor 10 Ohm/1000 W	A76178-003
10	Spare fuse F1, Siba 10 A/415 V/slow-blow	B94138-010-000
EMC accessories		
11	Ferrite cores	External supplier: Neosid Pemetzrieder KG Postfach 1344 58553 Halver 1 Germany Tel.: +49-2353-710 Fax: +49-2353-7154
12	Mains filters from Schaffner 3-phase: FN251- XX -07 FN351- XX -29 1-phase: FN250- XX -07 FN350- XX -29 The rated current must be specified in place of XX , e.g. 16 for 16 A	Schaffner Elektronik GmbH Schoemperlenstrasse 12B 76185 Karlsruhe Tel.: +0049-721-569-10 Fax: +0049-721-569-110 Schaffner Elektronik AG CH-4708 Luterbach Switzerland Tel.: +0041-65-802-626 Fax: +0041-65-802-641
13	Mains filters from Siemens 3-phase: B84143-A XX -R 1-phase: B84142-B XX -R The rated current must be specified in place of XX , e.g. 16 for 16 A	Siemens AG Richard Strauss Strasse 76 81679 München Tel.: +0049-89-9221-0 Fax: +0049-89-9221-4390

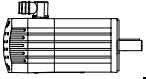

6 Rack and Backplane

6.1 Rack	3
6.1.1 Filler panels.....	3
6.1.2 Fans	4
6.2 Backplanes	5
6.2.1 Dimensions	5
6.2.2 Backplane overview	6
6.3 Backplane with front connectors	7
6.4 Backplane Connections	8
6.4.1 T160-9xx Power Supply Connections.....	8
6.4.2 T161-90x Servocontroller Connections	9
6.4.3 Commissioning interface connector X6	10
6.4.4 Fan Connector X9.....	11
6.5 Order data	12

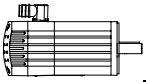

6.1 Rack

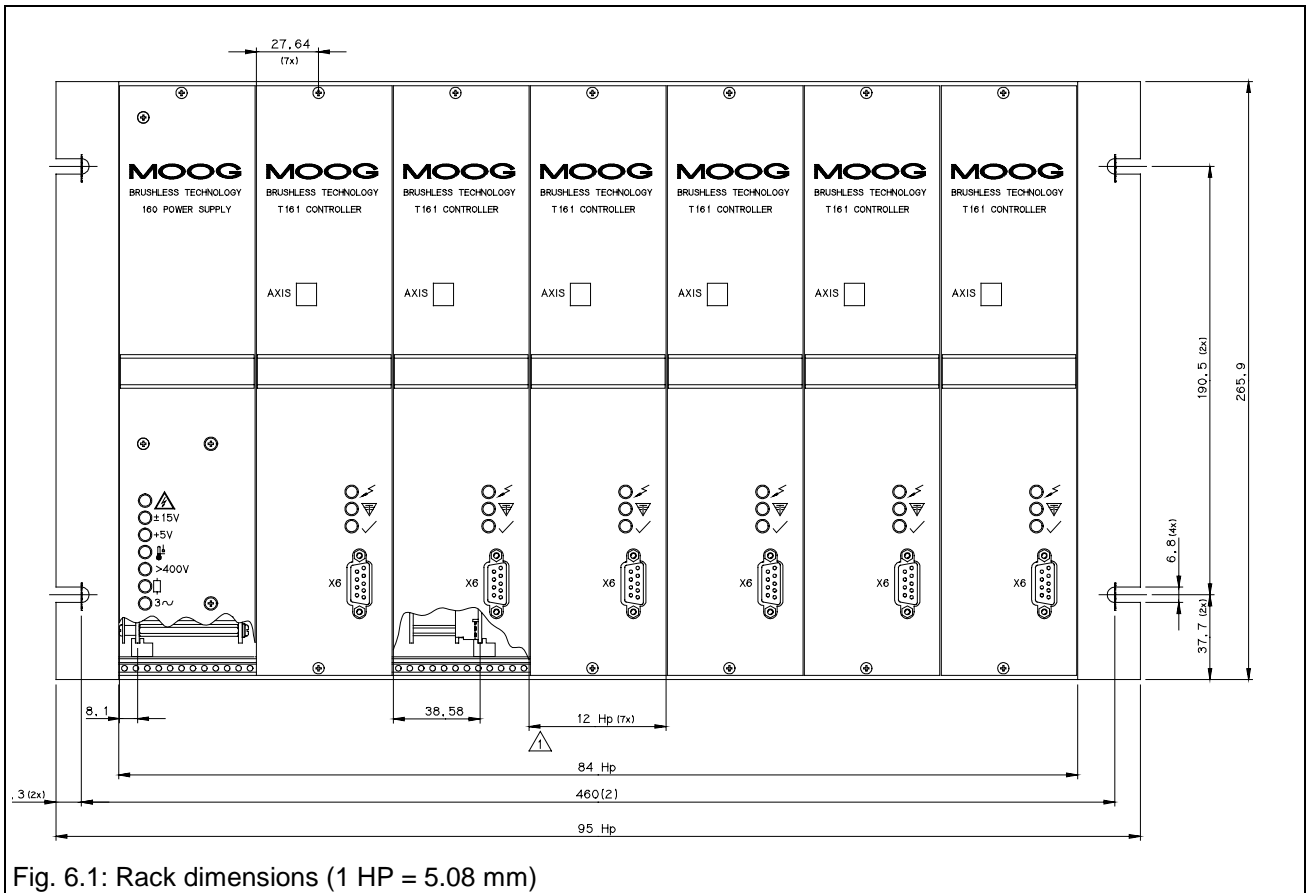

6.1.1 Filler panels

Width 12 HP: For covering unused slots in the rack.

Width 6 HP: For covering the gap (1/2 slot) when using a T161-904 servocontroller in the rack.

6.1.2 Fans



Warning:

A fan is required if more than four servocontrollers are installed.

Then the fans must be switched on as soon as voltage is applied the power supply. If the power supply requires an external 24 VDC supply, the fan must be switched on as soon as the 24 VDC supply is connected.

Fan unit for the entire 19" rack

MOOG recommends the use of a commercially available 19" fan unit (reference list available on request).

Single fan unit

The single fan unit (see Fig 6.2) is supplied with guide rails and can be installed directly into the rack from below. It is suitable for cooling two servocontrollers of T161-9x1 to T161-9x3 or for one power supply unit T160-9xx and one servocontroller (fan capacity 70 m³/h).



Note:

The single fan unit can only be installed in a Schroff rack.

Supply voltage: 1 x 230 VAC

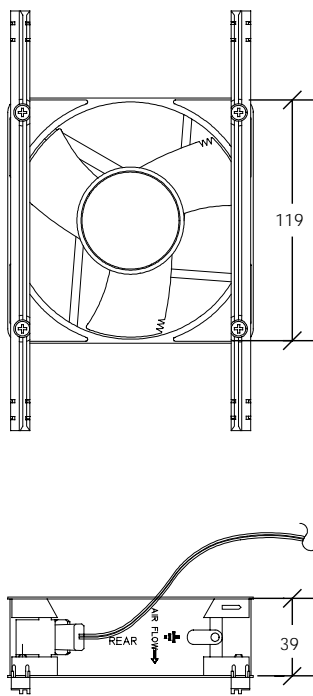
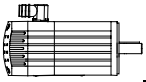

Fig. 6.2: Single fan unit



6.2 Backplanes

6.2.1 Dimensions

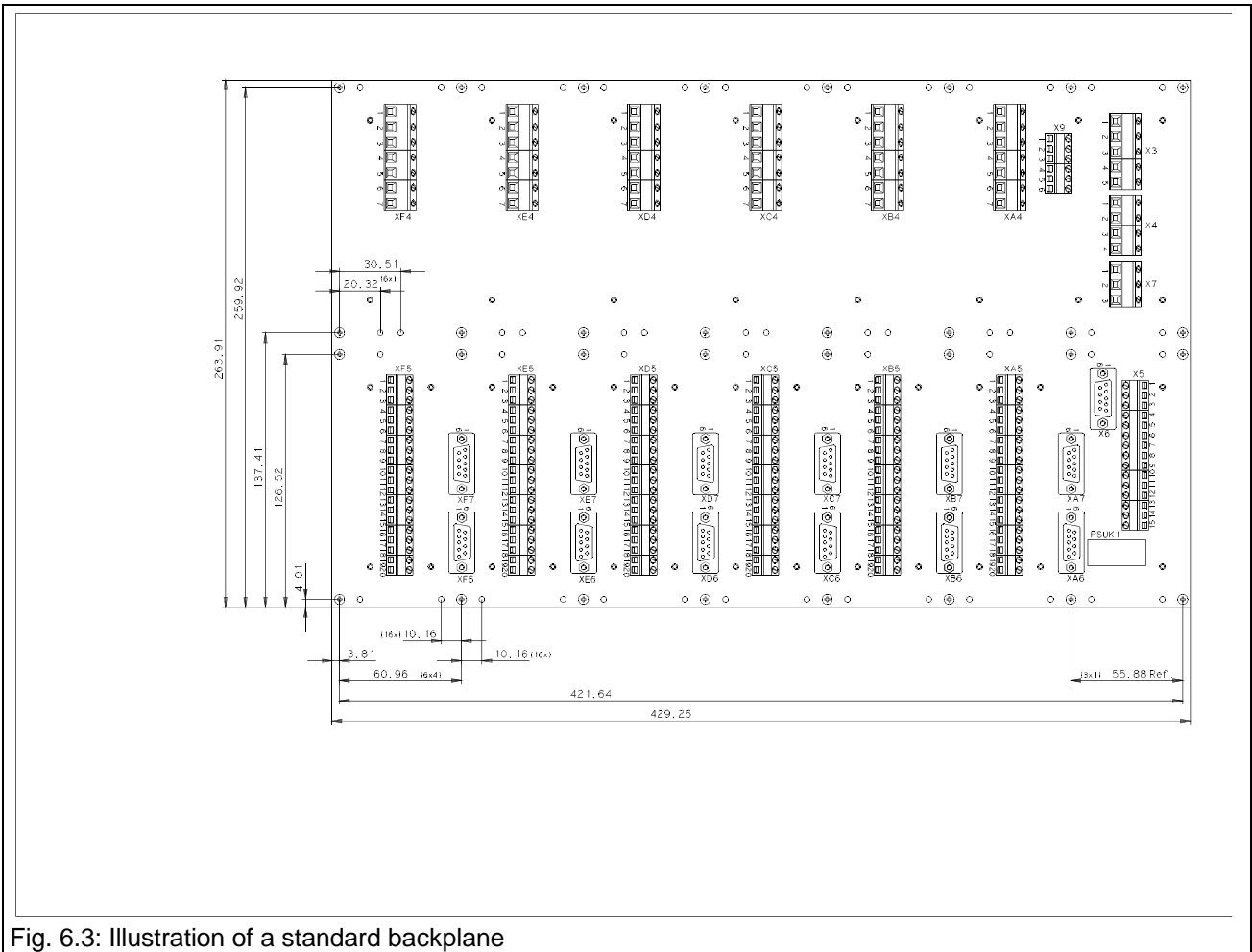

Fig. 6.3: Illustration of a standard backplane

6-axis backplane

The 6-axis backplane can accommodate a power supply unit and up to six servocontrollers of type T161-9x1 to T161-9x3. It can also be delivered complete with rack. A servocontroller of type T161-9x4 occupies 1.5 slots.

Dimensions (W x H in mm): 429.26 x 263.91

4-axis backplane

The 4-axis backplane can accommodate a power supply unit and up to four servocontrollers of type T161-9x1 to T161-9x3. A servocontroller of type T161-9x4 occupies 1.5 slots.

Dimensions (W x H in mm): 304.8 x 265.9

2-axis backplane

The 2-axis backplane can accommodate a power supply unit and one or two servocontrollers of type T161-9x1 to T161-9x3. A servocontroller of type T161-9x4 occupies 1.5 slots.

Dimensions (W x H in mm): 182.88 x 265.9

6.2.2 Backplane overview

Function	B48332 - 001 (6 axes) B48333 - 001 (4 axes) B48334 - 001 (2 axes)	B94101-006 (6 axes) B94101-004 (4 axes) B94101-003 (3 axes) B94101-002 (2 axes)	BP with front connectors B80168 - 001 (6 axes) B80167 - 001 (4 axes) B80166 - 001 (3 axes) B80165 - 001 (1 axis)	B48332 - 701 (6 axes) B48333 - 701 (4 axes) B48334 - 701 (2 axes) B48336 - 701 (3 axes)	B48332 - 801 (6 axes) B48333 - 801 (4 axes) B48334 - 801 (2 axes) B48336 - 801 (3 axes)
Backplane is recommended for	replacement in existing systems	±10 V speed-/torque-controlled drive systems	±10 V speed-/torque-controlled drive systems	CAN Profile Mode drive systems	CAN Interpolation Mode drive systems
Backplane is recommended for the following, subject to reservations	both CAN drive systems, if brake control is not required	both CAN drive systems, if brake control is not required	both CAN drive systems, if brake control is not required	CAN Interpolation Mode drive systems if external signals are required	CAN Profile Mode drive systems if external signals are not necessary
Suitable for ±10 V reference	yes	yes	yes	yes	no
Suitable for Encoder Simulation board ESM II	no	yes	yes	no	no
Suitable for Encoder Simulation board ESM III	no	yes	yes	no	no
Suitable for CAN	yes from revision F	yes from revision B	yes	yes	yes
Relay for brake control	no	no	no	yes	yes
All signal connectors for servocontroller stuffed	yes	yes	yes	yes	no, no connectors stuffed
"System Ready" relay stuffed	no	no	no	yes	yes
"Servocontroller Ready" relay can be used	yes	yes	yes	no, only "System Ready" relay can be accessed (AND logic)	no, only "System Ready" relay can be accessed (AND logic)
Connectors	Screw terminals	Screw terminals	Plug connectors	Screw terminals	Screw terminals

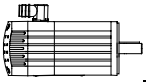

6.3 Backplane with front connectors

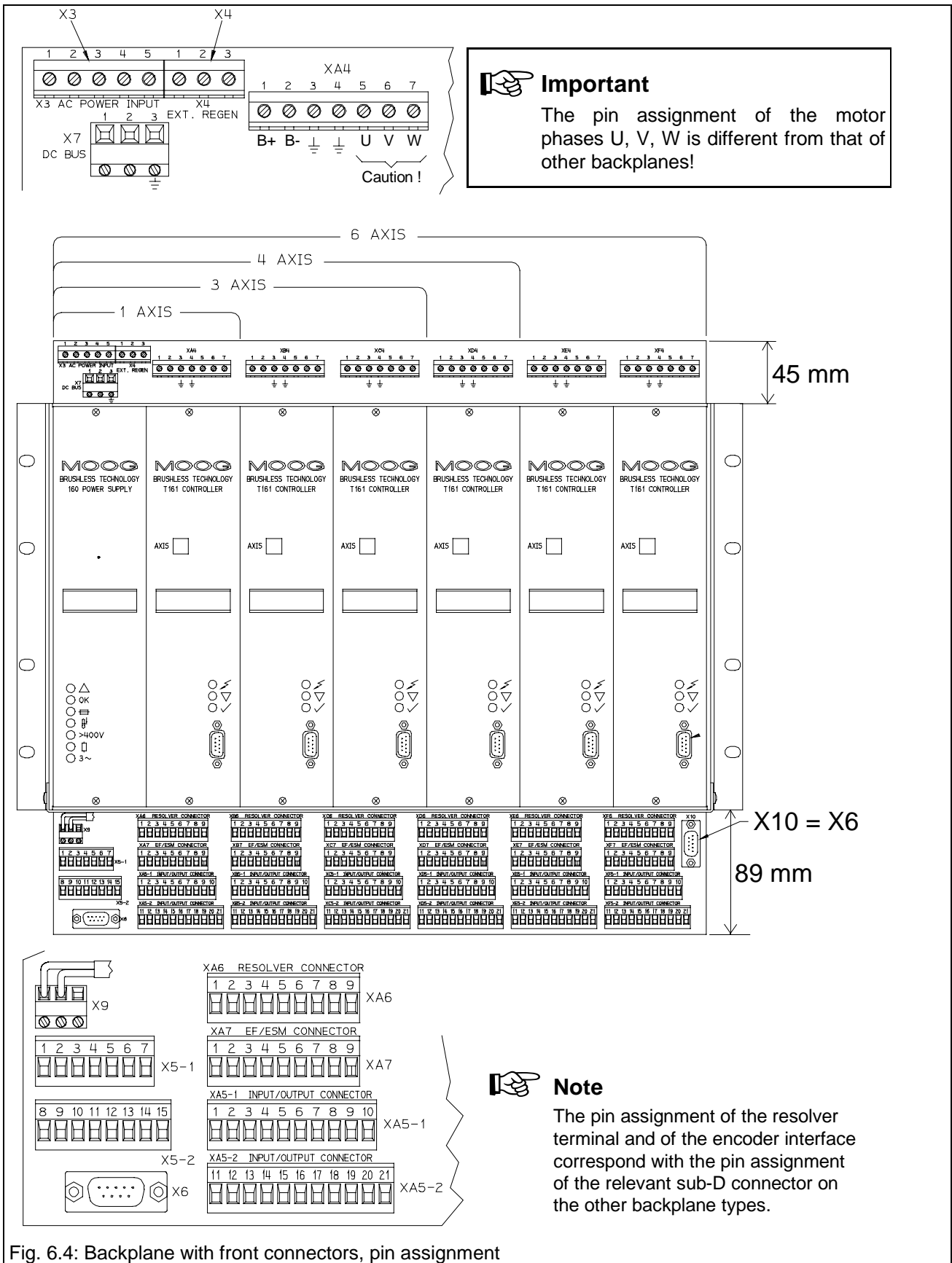

Fig. 6.4: Backplane with front connectors, pin assignment

6.4 Backplane Connections

6.4.1 T160-9xx Power Supply Connections

6.4.1.1 Power Supply Connector X3

Type:	Phoenix GSMKDS3 (angled screw terminal)		
Wire cross-sectional area:	max. 3 mm ²		
Pin assignment:			
Pin 1:	PE	Protective Earth	Input/Output Reference
Pin 2:	L1	Mains Input, Phase 1, 230 V _{rms} AC 50/60 Hz	Input, Ref: PE (X3/1)
Pin 3:	L2	Mains Input, Phase 2, 230 V _{rms} AC 50/60 Hz	Input, Ref: PE (X3/1)
Pin 4:	L3	Mains Input, Phase 3, 230 V _{rms} AC 50/60 Hz	Input, Ref:PE (X3/1)
Pin 5:	PE	Protective Earth	Input/Output Reference

6.4.1.2 External Bleed Resistor Connector X4

Type:	Phoenix GSMKDS3 (angled screw terminal)		
Wire cross-sectional area:	max. 3 mm ²		
Pin assignment:			
Pin 1:	ReGen1	External Bleed Resistor 1	Output, Ref:ReGen2
Pin 2:	ReGen2	External Bleed Resistor 2	Output
Pin 3:	PE	Protective Earth	Input/Output Reference
Pin 4:	NC	Not Connected	

6.4.1.3 Low Voltage Power and Status Connector X5

Type:	Phoenix GSMKDS1,5 (angled screw terminal)		
Wire cross-sectional area:	max. 1,5 mm ²		
Pin assignment:			
Pin 1:	24 V B+	24 V Brake Supply Plus	Input, Ref:24 V B- (X5/2)
Pin 2:	24 V B-	24 V Brake Supply Ground	Input Reference
Pin 3:	24 V E+	24 V External Supply Plus (Optional)	Input, Ref: 24 V E- (X5/4)
Pin 4:	24 V E-	24 V External Supply Ground (Optional)	Input Reference
Pin 5:	PSRly1	Power Supply OK Relay, Pin 1	Output, Ref: PSRly2 (X5/6)
Pin 6:	PSRly2	Power Supply OK Relay, Pin 2	Output Reference
Pin 7:	PE	Protective Earth	Input/Output Reference
Pin 8:	+5 V	+5 V Power Supply Output	Output, Ref: DGND (X5/12)
Pin 9:	+15 V	+15 V Power Supply Output	Output, Ref: AGND (X5/11)
Pin 10:	-15 V	-15 V Power Supply Output	Output, Ref: AGND (X5/11)
Pin 11:	AGND	Analog Ground	Input/Output Reference
Pin 12:	DGND	Digital Ground	Input/Output Reference
Pin 13:	SRRly1	System Ready Relay, Pin 1 (Optional)	Output, Ref: SRRly2 (X5/14)
Pin 14:	SRRly2	System Ready Relay, Pin 2 (Optional)	Output Reference
Pin 15:	Dig. Input	Digital input for servocontroller (function depends on servocontroller and backplane type)	Input, Ref: ExtIO_GND of servocontroller (Xμ5/14)

6.4.1.4 DC Bus Connector X7

Type:	Phoenix GSMKDS3 (angled screw terminal)		
Wire cross-sectional area:	max. 3 mm ²		
Pin assignment:			
Pin 1:	DC+	High Power DC Bus Plus	Output, Ref:DC- (X7/2)
Pin 2:	DC-	High Power DC Bus Minus	Output Reference
Pin 3:	PE	Protective Earth	Input/Output Reference



6.4.2 T161-90x Servocontroller Connections

Servocontroller μ ($\mu = A \dots F$)

6.4.2.1 Power Connector $X_{\mu 4}$			
Type:	Phoenix GSMKDS3 (angled screw terminal)		
Wire cross-sectional area:	max. 3 mm ²		
Pinbelegung:			
Pin 1:	Brake+	Motor Brake Connection, Plus (Optional)	Input, Ref: Brake- ($X_{\mu 4/2}$)
Pin 2:	Brake-	Motor Brake Connection, Minus (Optional)	Input Reference
Pin 3:	PE	Protective Earth	Input/Output Reference
Pin 4:	PE	Protective Earth	Input/Output Reference
Pin 5:	Motor_W *)	Motor phase W	Output, Ref: PE ($X_{\mu 4/4}$)
Pin 6:	Motor_V *)	Motor phase V	Output, Ref: PE ($X_{\mu 4/4}$)
Pin 7:	Motor_U *)	Motor phase U	Output, Ref: PE ($X_{\mu 4/4}$)
*) for Backplane B80165-001, B80166-001, B80167-001, B80168-001 applies: Pin5 = Motor phase U, Pin 6 = Motor phase V, Pin 7 = Motor phase W.			
Motor connector pinout:			
Motor:	Pin assignment (brake+: B+ and brake-: B-)		
G422	Pin 5: B+	Pin 6: B-	Pin 1: W Pin 4: V Pin 2: U
G423	Pin 5: B+	Pin 6: B-	Pin 1: W Pin 4: V Pin 2: U
G424	Pin 5: B+	Pin 6: B-	Pin 1: W Pin 4: V Pin 2: U
G425	Pin +: B+	Pin -: B-	Pin W: W Pin V: V Pin U: U

6.4.2.2 Resolver Connector $X_{\mu 6}$			
Type:	9 pin Sub-D connector, female		Motor connector pin assignment
Pin 1:	S3	Resolver Feedback, SIN +	Input Pin 2
Pin 2:	Thrm1	Motor Thermistor, Pin 1	Input, Ref: DGND ($X_{\mu 6/5}$) Pin 5
Pin 3:	S2	Resolver Feedback, COS +	Input Pin 3
Pin 4:	R1	Resolver Supply Plus	Output, Ref: R ($X_{\mu 6}$) Pin 7
Pin 5:	Thrm2	Motor Thermistor, Pin 2	Input Pin 6
Pin 6:	S1	Resolver Feedback, SIN -	Input Pin 1
Pin 7:	PE	Protective Earth	Input/Output Reference
Pin 8:	S4	Resolver Feedback, COS -	Input Pin 4
Pin 9:	R2	Resolver Supply Minus	Input Pin 8

6.4.2.3 I/O Connector $X_{\mu 5}$			
Type:	Phoenix GSMKDS1,5 (angled screw terminal)		
Wire cross-sectional area:	max. 1,5 mm ²		
Pin assignment:			
Pin 1:	SysRdy1	System Ready Relay, Pin 1	Output, Ref: SysRdy2 ($X_{\mu 5/2}$)
Pin 2:	SysRdy2	System Ready Relay, Pin 2	Output
Pin 3:	PrAnaOut	Programmable Analog Output (+/-10 V) Default: Actual Velocity Monitor	Output, Ref: AGND ($X_{\mu 5/5}$)
Pin 4:	IDC	Equivalent DC Motor Current Monitor (+/-10 V)	Output, Ref: AGND ($X_{\mu 5/5}$)
Pin 5:	AGND	Analog Ground	Input/Output Reference
Pin 6:	Dig. Input_1	Digital Input 1 (function: see section 4)	Input, Ref: ExtIO_GND ($X_{\mu 5/14}$)
Pin 7:	Dig. Input_2	Digital Input 2 (function: see section 4)	Input, Ref: ExtIO_GND ($X_{\mu 5/14}$)
Pin 8:	PE	Protective Earth	Input/Output Reference
Pin 9:	Dig. Input_3	Digital Input 1 (function: see section 4)	Input, Ref: ExtIO_GND ($X_{\mu 5/14}$)
Pin 10:	Enable	Axis Enable Input	Input, Ref: ExtIO_GND ($X_{\mu 5/14}$)
Pin 11:	PE	Protective Earth	Input/Output Reference
Pin 12:	Dig. Input_4	Digital Input 1 (function: see section 4)	Input, Ref: ExtIO_GND ($X_{\mu 5/14}$)
Pin 13:	ExtIO_V+	External I/O Supply Voltage Input	Input
Pin 14:	ExtIO_GND	External I/O Ground Input Reference für $X_{\mu 5}$ Pin 6, 7, 9, 10, 12	Input
Pin 15:	ThrmRly1	Thermal Limit Relay, Pin 1	Output, Ref: ThrmRly2 ($X_{\mu 5/16}$)
Pin 16:	ThrmRly2	Thermal Limit Relay, Pin 2	Output
Pin 17:	Analog Input_2+	Analog Input 2, Plus (function: see section 4)	Input, Ref: Analog Input_2- ($X_{\mu 5/18}$)
Pin 18:	Analog Input_2-	Analog Input 2, Minus (function: see section 4)	Input
Pin 19:	Analog Input_1+	Analog Input 1, Plus (function: see section 4)	Input, Ref: Analog Input_1- ($X_{\mu 5/20}$)
Pin 20:	Analog Input_1-	Analog Input 1, Minus (function: see section 4)	Input

6.4.2.4 Encoder Simulation Connector X μ 7

Type:	9 pin Sub-D connector, male		
Pin assignment:			
Pin 1:	GNDExtES	External Ground Encoder Simulation	Input/Output Reference Output, Ref: GNDExtES or GNDIntES (internal ground encoder simulation); for differential output: Ref: M (X μ 7/6)
Pin 2:	/M	Negated Reference Pulse	
Pin 3:	/B	Negated Channel B	Output, Ref: GNDExtES or GNDIntES (internal ground encoder simulation); for differential output: Ref: B (X μ 7/7)
Pin 4:	/A	Negated Channel A	
Pin 5:	VExtES	External Encoder Simulation Supply Voltage	Output, Ref: GNDExtES or GNDIntES (internal ground encoder simulation); for differential output: Ref: A (X μ 7/8)
Pin 6:	M	Reference Pulse	
Pin 7:	B	Channel B	Input, Ref: GNDExtES (X μ 7/1) Output, Ref: GNDExtES or GNDIntES (internal ground encoder simulation); for differential output: Ref: /M (X μ 7/2)
Pin 8:	A	Channel A	
Pin 9:	Shield	Shield (connected to Protective Earth)	Output, Ref: GNDExtES or GNDIntES (internal ground encoder simulation); for differential output: Ref: /B (X μ 7/3)
			Output, Ref: /A (X μ 7/4)

6.4.3 Commissioning interface connector X6

6.4.3.1 Interface connector X6/RS232

Type:	9 pin sub-D connector, female		
Location:	Front panel of the controller T161-90x		
Pin assignment:			
Pin 1:	N/C	Not Connected	
Pin 2:	RxD	Read Data Input	Input, Ref.: DGND (X6/5)
Pin 3:	TxD	Transfer Data Output	Output, Ref.: DGND (X6/5)
Pin 4:	N/C	Not Connected	
Pin 5:	DGND	Digital Ground	Input/Output Reference
Pin 6:	PE	Protective Earth	Input/Output Reference
Pin 7:	N/C	Not Connected	
Pin 8:	N/C	Not Connected	
Pin 9:	+5 V	+5 V Output Supply Voltage	Output, Ref.: DGND (X6/5)
Interface protocol:	Baudrate:	9600	
	Startbits:	1	
	Databits:	7	
	Paritybit:	ignored	
	Stopbits:	2	

6.4.3.2 Interface connector X6/RS485/CAN

Type:	9 pin sub-D connector, male		
Location:	Backplane		
Pin assignment:			
Pin 1:	CAN-BUS	Digital Serial Input/Output (Option)	
Pin 2:	CAN-BUS	Digital Serial Input/Output (Option)	
Pin 3:	RS485+	RS485 Bus Interface, Plus	Input/Output
Pin 4:	RS485-	RS485 Bus Interface, Minus	Input/Output
Pin 6:	PE	Protective Earth	Input/Output Reference
Pin 7:	N/C		Input/Output Reference
Pin 8:	N/C		
Pin 9:	N/C		

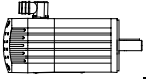

6.4.4 Fan Connector X9

Type:	Phoenix SMKDS1,5 (angled screw terminal)		
Wire cross-sectional area:	max. 1,5 mm ²		
Pin assignment:			
Pin 1:	L1	Mains Phase 1, 230 V _{rms} AC 50/60 Hz	Output, Ref: L2 (X9/2)
Pin 2:	L2	Mains Phase 2, 230 V _{rms} AC 50/60 Hz	Output
Pin 3:	L1	Mains Phase 1, 230 V _{rms} AC 50/60 Hz	Output, Ref: L2 (X9/4)
Pin 4:	L2	Mains Phase 2, 230 V _{rms} AC 50/60 Hz	Output
Pin 5:	L1	Mains Phase 1, 230 V _{rms} AC 50/60 Hz	Output, Ref: L2 (X9/6)
Pin 6:	L2	Mains Phase 2, 230 V _{rms} AC 50/60 Hz	Output

6.5 Order data

No.	Description	MOOG Order No.
1	Backplanes	See "Backplane overview"
2	Rack (basic version)	B47359-001
3	Filler panel 12 HP (for unused slots)	B53473-001
4	Filler panel 6 HP (for T161-9x4)	B80016-001
5	Single fan unit	B53498-001
6	<p>Rack conforming to EMC requirements, comprising:</p> <p>20845-311, quantity: 1 Europac Lab HF Subrack Kit (84 HP x 6 U x 340 mm)</p> <p>20845-175, quantity: 1 Shielded backplane (84 TE x 6 HE)</p> <p>30845-253, quantity: 2 Perforated strip (84 TE)</p> <p>30819-594, quantity: 4 Threaded strip (84 TE)</p> <p>21100-275, quantity: 1 Stud bolt</p> <p>30837-619, quantity: 2 Module rail, rear (84 TE)</p> <p>30837-200, quantity: 1 Profiled rail (84 TE)</p> <p>60817-061, quantity: 4 Insulating strip</p> <p>21100-824, quantity: 1 Locating pins to secure the insulating strip</p>	<p>Schroff GmbH Langenalber Strasse 96-100 D-75334 Straubenhardt Germany Tel.: +0049-7082-794-0 Fax: +0049-7082-794-200</p> <p>Important: This is a standard rack made by Schroff. There are no grommets in the rack upon delivery. They have to be inserted by the customer.</p>

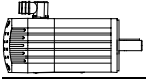

7 Servomotors

7.1 Nameplate	3
7.1.1 Motor type for series G400 servomotors	3
7.2 Principal operation of a brushless servomotor	4
7.3 Technical data	6
7.3.1 Standards for MOOG Motors	6
7.3.2 Tolerances of the shaft and flange	9
7.3.3 Operating and ambient conditions	9
7.3.4 Performance data	10
7.3.5 Mounting dimensions of MOOG motors	11
7.4 Installation instructions	12
7.4.1 Safety instructions	12
7.4.2 Mechanical installation	14
7.4.3 Electrical interfaces	15
7.5 Partnumber cross reference	17
7.6 If repairs are required	17

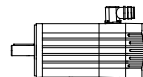

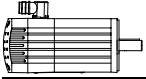

7.1 Nameplate

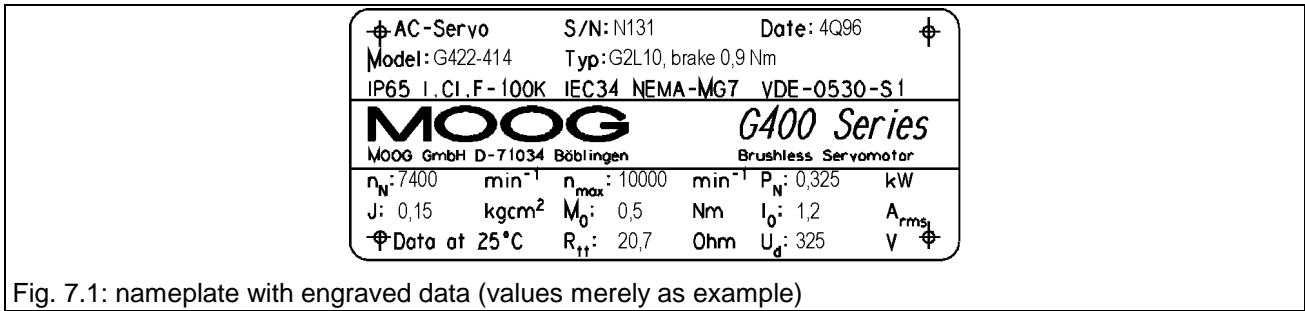

Fig. 7.1: nameplate with engraved data (values merely as example)

- S/N: serial number
- Date: production quarter and year
- Model: motor model number
- Type: electric model, description optional brake
- n_N : nominal speed (speed at P_N)
- n_{max} : maximum speed
- P_N : nominal power (maximum continuous power)
- J: moment of inertia
- M_0 : continuous stall torque
- I_0 : continuous stall current
- R_{tt} : terminal to terminal resistance
- U_d : bus voltage

Further motor data can be found in the catalogue.



The name plate identifies the product.
For this reason:

- Check whether the name plate on the motor matches the name plate illustrated above.
- This documentation must not be used for commissioning and startup if the name plates do not match.
- Devices without name plate are not covered by the manufacturer's warranty and must not be put into operation.

7.1.1 Motor type for series G400 servomotors

All motor specific data in this handbook is associated to flange size and length of the motors. Flange size and standard length are determined as follows.

Motor size: Determined by the 4th digit of the model number (e.g. Size G4x**2**-in the model number G422-414) and 2nd digit of the model type (e.g. G**2**L10).

Standard length: Can be determined by means of the partnumber cross reference (see table 7.9) by the 6th digit of the model number (e.g. length G4xx-**4**xx in the model number G422-**4**14). The easier way is to look at the 4th and 5th digit of the model type on the nameplate (e.g. G2**L10**).

Model type: A model type designation (e.g. G2L10) is described by the following scheme: GxLyyz with x = motor size; yy = motor length; z = electric model (dropped for standard motors).

Brake: The minimum torque of an optional brake is added to the model type on the nameplate (for instance G2L10, **brake** 0,9 Nm).

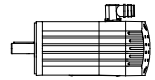

7.2 Principal operation of a brushless servomotor

The mechanical design of the brushless (bl.) servomotor is similar to a synchronous machine, while its principle of operation corresponds with that of a conventional DC motor with brushes where rotor and stator are exchanged.

In a conventional DC motor, the rotor rotates in a stationary magnetic field whereas in the bl. servomotor this field is rotating with the rotor. This exciting field can be obtained by an ordinary winding as well as by a permanent magnet. **For MOOG-Motors this is always a high-energy permanent magnet.**

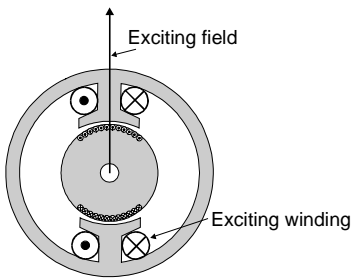

Fig. 7.2: Principle of DC motor

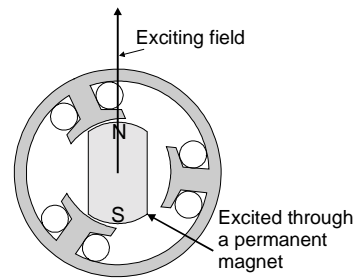

Fig. 7.3: Principle of servomotor

To obtain torque, the motor must have another winding. The current in this winding causes another magnetic field which has to be **rectangular to the exciter field** for maximum torque. When the rotor is turning, in this second winding a voltage is induced (EMF). Those windings are called armature windings in literature. With the DC-motor this winding is in the rotor, whereas in the brushless servomotor it is in the stator.

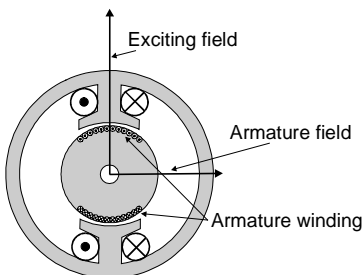

Fig. 7.4: DC motor with magnetic fields

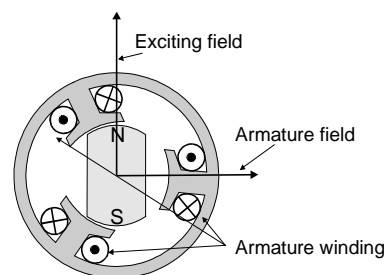

Fig. 7.5: Servomotor with magnetic fields

The decisive disadvantages inherent in the underlying principle of a **DC motor** are:

- Limited static torque
- High degree of wear and mechanical friction
- Large size
- Limited resistance to overloading
- Poor transfer of dissipated heat from the rotor outwards.

In a brushless servomotor, the basic principles of the stator and rotor are exactly the other way round. The magnetic field of the rotor is the exciting field and rotates in accordance with the rotor speed. The rotor position is transmitted to the controller via a resolver and the stator winding is then connected in such a way as to yield a magnetic field which is always offset 90° in relation to the rotor field. In this case, the winding is switched by the power electronics instead of being switched mechanically by the commutator, as in a conventional DC machine. Unlike the mechanical commutator, the power electronics is maintenance-free and wear-free.

Load fluctuations are controlled via the current intensity as in a conventional DC motor. The torque is once again proportional to the current, thus yielding equally good control capabilities.

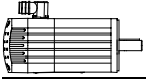

The following diagrams similarly illustrate two load cases:

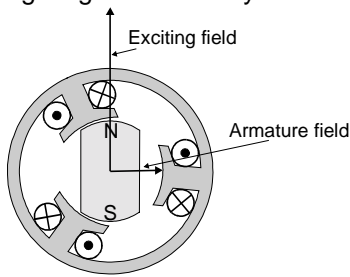

Fig. 7.6: BL servomotor, low load

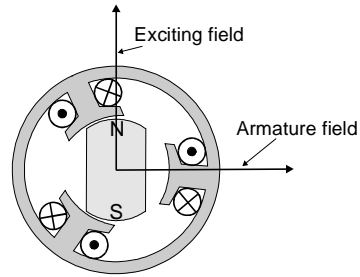

Fig. 7.7: BL servomotor, high load

The synchronous motor (SM), with a mechanical design similar to the servomotor but rarely with permanent magnets, is used in a different operating mode.

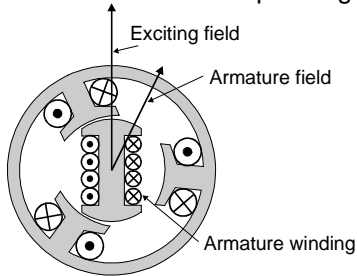

Fig. 7.8: Synchronous motor, low load

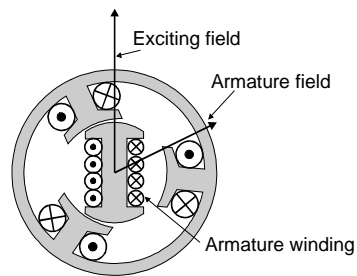

Fig. 7.9: Synchronous motor, high load

Load fluctuations cause different angles between the two magnetic fields, whereas the armature field stays constant.

The decisive disadvantages inherent in the underlying principle of a **synchronous motor** are:

- Bad controllability
- Low efficiency due to reactance currents

The disadvantages listed above for conventional DC motors and synchronous motors do not apply for the brushless motor.

The **MOOG motor** is consequently characterized by the following points:

- High torque yield with small motor size
- High overload capacity
- Full torque over the entire speed range
- Highly dynamic due to the slight inertia
- Good controllability
- High efficiency
- Little friction
- Maintenance-free operation
- Robust design

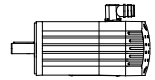

7.3 Technical data

7.3.1 Standards for MOOG Motors

The brushless MOOG servomotors of series G400 have been designed, assembled and tested in conformity with the following standards.

Standard	International	Europe	Deutschland	USA
English	IEC International Electrotechnical Commission	EN CENELEC Europäisches Komitee für Elektrotechnische Normung	DIN / VDE Deutsche Industrie Norm / Verband Deutscher Elektrotechniker	NEMA / NEC National Electric Code MG.-...
Certified company	ISO 9001	EN ISO 9001	DIN ISO 9001	ISO 9001
Quality systems - model for quality assurance in design / development, production, installation and servicing	ISO 9001	EN ISO 9001	DIN ISO 9001	ISO 9001
Machine guidelines (CE Machine safety directive)	89/392/EWG, 91/368/EWG, 93/44/EWG	89/392/EWG, 91/368/EWG, 93/44/EWG	89/392/EWG, 91/368/EWG, 93/44/EWG	
EMC guidelines (CE-EMC directive)	89/336/EWG, 93/68/EWG, 93/44/EWG	89/336/EWG, 93/68/EWG, 93/44/EWG	89/336/EWG, 93/68/EWG, 93/44/EWG	
Low voltage guidelines (CE-Low voltage directive)	73/23/EWG, 93/68/EWG, 93/44/EWG	73/23/EWG, 93/68/EWG, 93/44/EWG	73/23/EWG, 93/68/EWG, 93/44/EWG	
Standard for safety of electric motors				UL 1004 (1994)
Safety of machinery, electrical equipment of machines, part 1: general requirements	IEC 204-1	EN 60204-1	DIN EN 60204-1 VDE 0113-1	

Table 7.1

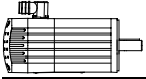

Relevant standards for electrical equipment

Standard	International	Europe	Deutschland	USA
English	IEC International Electrotechnical Commission	EN CENELEC Europäisches Komitee für Elektrotechnische Normung	DIN / VDE Deutsche Industrie Norm / Verband Deutscher Elektrotechniker	NEMA / NEC National Electric Code MG.-...
Rotating electrical machines, Rating and performance	IEC 34-1 IEC 2/915/CDV: 1995	EN 60034-1	DIN EN 60034-1 VDE 0530-1	MG 1-1.65
Rotating electrical machines, Methods for determining losses and efficiency and performance	IEC 2G/73/FDIS	EN 60034-2	DIN EN 60034-2 VDE 0530-2	
Rotating electrical machines, Classification of degrees of protection provided by enclosure	IEC 34-5	EN 60034-5	DIN EN 60034-5 VDE 0530-5	MG 1-1.25 MG 1-1.26
Rotating electrical machines, Methods of cooling (IC-Code)	IEC 34-6	EN 60034-6	DIN EN 60034-6 VDE 0530-6	MG 1-1.25 MG 1-1.26
Rotating electrical machines, Classification of types of construction and mounting arrangements (IM Code)	IEC 34-7	EN 60034-7	DIN EN 60034-7 VDE 0530-7	MG 1-4.03
Rotating electrical machines, Terminal markings and directions of rotation	IEC 34-8	EN 60034-8	DIN EN 60034-8 VDE 0530-8	MG 1-2.61
Rotating electrical machines, Noise limits	IEC 34-9	EN 60034-9	DIN EN 60034-9 VDE 0530-9	N/A.
Insulation coordination for equipment with low-voltage systems. Part 1: Principles, requirements and tests	IEC 664-1		VDE 0110-1	
Insulation coordinates for equipment with low-voltage systems. Part 2: Partial discharge tests, application guide	IEC 664-2		VDE 0110-2	
Connectors and plug-and-socket-devices, for rated voltages up to 1000 V AC, up to 1200 V DC and rated currents up to 500 A for each pole			DIN VDE 0627	

Table 7.2

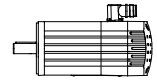

Relevant standards for mechanical design

Standard	International	Europe	Deutschland	USA
English	IEC International Electrotechnical Commission	EN CENELEC Europäisches Komitee für Elektrotechnische Normung	DIN / VDE Deutsche Industrie Norm / Verband Deutscher Elektrotechniker	NEMA / NEC National Electric Code MG.-...
Degrees of protection provided by enclosure (IP code)	IEC 529	EN 60529	DIN EN 60529 VDE 0470-1	
Cylindrical shaft ends for electrical machines	IEC 72 ISO/R 775-1969		DIN 748-1 & 3	MG-11...
Mounting flanges for rotating electrical machinery			DIN 42948	
Dimensions, tolerances and mounting				NEMA MG-7
Tolerances of shaft extension run-out and of mounting flanges for rotating electrical machinery	IEC 72		DIN 42955	
Mechanical vibration, balance quality requirements of rigid rotors, determination of permissible residual unbalance	ISO 1940-1		DIN ISO 1940-1	
Mechanical vibration, balance quality requirements of rigid rotors, Balance errors	ISO 1940-2		DIN ISO 1940-2	
Ball bearings, conrad type, for electrical machines, tolerances and radial clearance			DIN 42966	
Drive type fastenings without taper action, parallel keys, keyways, deep pattern			DIN 6885-1	
ISO general purpose metric screw threads. Part 1 coarse pitch threads in diameter range 1 mm to 68 mm, nominal sizes	ISO 724		DIN 13-1	
General tolerances, tolerances for linear and angular dimensions without individual tolerance indications	ISO 2768-1	EN 22768	DIN ISO 2768-1	

Table 7.3

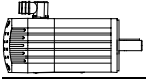

7.3.2 Tolerances of the shaft and flange

7.3.2.1 Runout

Note: All brushless MOOG servomotors of series G400 have been developed in conformity with DIN 42955 / IEC72, runout class R.

Diameter of the shaft extension $\varnothing U$ [mm]	maximum runout tolerance class R [mm]
to 10	0.015
over 10 to 18	0.018
over 18 to 30	0.021
over 30 to 50	0.025
L = AH (see table 7.7)	

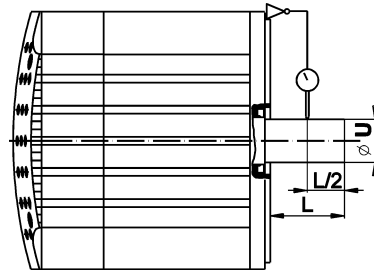

Rundlauf / runout

Table 7.4

7.3.2.2 Concentricity and perpendicularity

Note: Regarding concentricity and perpendicularity, all brushless MOOG servomotors of series G400 have been developed in conformity with DIN 42955 / IEC72, class R.

Pilot diameter of mounting flange $\varnothing AK$ [mm]	maximum concentricity and perpendicularity tolerances class R [mm]
to 22	0.025
over 22 to < 40	0.03
40 to 100	0.04
over 100 to 230	0.05
over 230 to 450	0.063
x = 10 ± 1 mm	

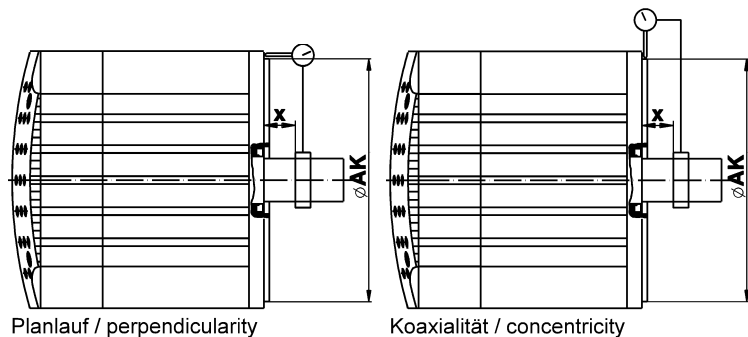

Planlauf / perpendicularity

Koaxialität / concentricity

Table 7.5

7.3.3 Operating and ambient conditions

Temperature for transport and storage: -25 °C to 90 °C

Operating temperature: -25 °C to 155 °C (higher temperature rating on demand)

Degree of protection: IP67 (DIN VDE 0470-1, EN 60529, IEC 529)
(at shaft extension optional shaft seal is needed)

Installed position: Any (good heat dissipation permits higher continuous power)

Ambient temperature in operation: -25 °C to 55 °C (motor continuous power is automatically limited by controller at temperatures over 55 °C)

Runout: Class R (DIN 42955-R, IEC72)

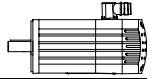

7.3.4 Performance data

Motor type		Stall data				Nominal data				Miscellaneous data						
		Continuous stall torque ①	Continuous stall current ①	Peak stall torque	Peak stall current	Rated torque ②	Rated current ②	Rated power ②	Rated speed ②	theoret. no load speed ③	maximum permissible speed ④	Torque constant ⑤	Terminal to terminal resistance ⑥	Terminal to terminal inductance ⑥	Moment of inertia without brake	Mass without brake
Model	Type	M _o [Nm]	I _o [Arms]	M _{max} [Nm]	I _{max} [Arms]	M _n [Nm]	I _n [Arms]	P _n [W]	N _n [rpm]	N _{theo} [rpm]	N _{max} [rpm]	k _t [Nm/Arms]	R _{tt} [Ohm]	L _{tt} [mH]	J [kgcm ²]	m [kg]
G422-2xx	G2L05	0.25	0.65	0.5	1.9	0.18	0.5	150	8100	10200	11500	0.37	50.90	29.7	0.09	1.0
G422-4xx	G2L10	0.5	1.2	1.4	3.7	0.42	1.0	325	7400	9000	10000	0.42	20.70	15.7	0.13	1.2
G422-6xx	G2L20	0.95	2.15	2.6	6.4	0.74	1.6	530	6800	7900	9000	0.46	9.90	9.1	0.22	1.5
G422-8xx	G2L40	1.7	2.85	5	8.3	1.26	2.1	820	6200	6300	7000	0.60	6.30	7.2	0.41	2.3
G423-2xx	G3L05	0.6	1.6	1.5	4.6	0.49	1.2	450	8800	9600	10500	0.40	15.20	18.8	0.16	1.4
G423-4xx	G3L15	1.65	3.2	4.7	10.6	1.44	2.7	950	6300	7200	8000	0.53	4.90	8.5	0.39	2.0
G423-6xx	G3L25	2.55	3.4	8.5	12.4	2.29	3.1	1150	4800	4900	5500	0.75	5.10	10.3	0.62	2.6
G423-8xx	G3L40	3.7	4.2	13	16.3	3.43	3.8	1400	3900	4100	4500	0.90	4.10	8.9	0.97	3.5
G424-2xx	G4L05	1.3	3.1	3.2	9.0	1.0	2.3	580	5800	8800	10000	0.42	5.10	8.52	1.05	3.0
G424-4xx	G4L10	2.6	4.8	6.5	15.0	1.7	3.1	950	5500	6900	8000	0.54	2.70	5.78	1.55	3.6
G424-6xx	G4L20	4.7	6.7	12.5	20.0	4.0	5.7	1800	4300	5200	5800	0.70	1.50	4.60	2.60	4.7
G424-8xx	G4L40	8.2	9.2	22	28.0	6.3	7.1	2310	3500	4200	4700	0.89	0.90	3.50	4.70	6.9
G425-2xx	G5L10	5.8	9.5	12.2	24	4.6	7.5	2310	4800	6100	6800	0.61	0.86	4.29	4.60	7.7
G425-4xx	G5L20	11.2	11	25.8	33	9.2	9.0	3370	3500	3800	4200	1.02	0.74	4.81	8.00	9.9
G425-6xx	G5L30	16.6	12.9	40	38	14.0	10.9	3960	2700	3000	3300	1.29	0.64	4.84	11.50	12.1
G425-8xx	G5L50	25	14.8	60	43	20.0	11.8	4610	2200	2200	2400	1.69	0.56	5.44	18.40	16.6
G426-2xx	G6L15	14	22	37	72	9.1	14.2	3810	4000	5700	6300	0.64	0.23	1.86	27.20	15.1
G426-4xx	G6L30	27	30	73	95	15.5	17.2	4870	3000	4200	4700	0.90	0.14	1.54	52.10	21.1
G426-6xx	G6L45	39	38	108	117	25.5	24.8	6680	2500	3500	3900	1.03	0.11	1.46	77.00	27.1
G426-8xx	G6L60	51	43	146	134	34.0	28.6	7830	2200	3000	3300	1.19	0.10	1.46	102.00	33.1

① Motor flanged onto a steel plate 300 x 300 x 12 mm with the maximum permissible overheating of the winding at 100 K over a still air environment (max. 40 °C)

② The nominal point is the point for maximum continuous power

③ Speed at which the EMF of the motor is equal to the DC-bus voltage

④ Speed at which the EMF of the motor reaches 360 V

$$⑤ \quad k_t = \frac{M_N}{I_N} = \frac{[\text{Nm}]}{[\text{A}_{\text{RMS}}]}$$

⑥ Measured at 25 °C

Note: Shaded data is printed on the nameplate.

Table 7.6



7.3.5 Mounting dimensions of MOOG motors

Model	P _{max}	A				B	C	øAJ	øAK	AH	øU	BB _{max}	øBF	XD	R	S1xS2	D	BC	øE	F	G	H	M
	mm	mm	mm	mm	mm	mm	mm	mm	mm	mm	mm	mm	mm	mm	mm	mm	mm	mm	mm			Nm	
	ISO 286							ISO 286	ISO 286	ISO 286	DIN 748, ISO 286	ISO 286	ISO 286	ISO 286	ISO 286	DIN 6885	ISO 286				DIN 13-1	DIN 912 8.8	DIN 912 8.8
G4x2-	55	109,4	122,4	147,4	198,4	17,0	9,0	63	40 ^{+0,011 -0,005}	20	9 ^{+0,010 +0,001}	2,5	5,5	14	7,2	3x3	3	0	24 ^{+0,033 -0}	-	M2,5 x 8	M5 x 22	5
G4x3-	70	114,3	139,8	165,3	203,3	22,0	9,0	75	60 ^{+0,012 -0,007}	23	11 ^{+0,012 +0,001}	2,5	5,5	16	8,5	4x4	4	0	24 ^{+0,033 -0}	-	M2,5 x 8	M5 x 22	5
G4x4-	100	133,2	146,2	171,2	222,2	21,1	9,8	115	95 ^{+0,013 -0,009}	40	19 ^{+0,015 +0,002}	3	9	32	15,5	6x6	4	0	35 ^{+0,039 -0}	66,3	M4 x 16	M8 x 30	16
G4x5-	140	169,6	194,6	220,1	271,1	14,4	12,2	165	130 ^{+0,014 -0,011}	50	24 ^{+0,015 +0,002}	3,5	11	40	20	8x7	5	0	47 ^{+0,039 -0}	98,8	M4 x 16	M10 x 40	30
G4x6-	190	186,5	224,5	262,5	301,0	37,0	11,0	215	180 ^{+0,014 -0,011}	60	32 ^{+0,018 +0,002}	4	13,5	40	27	10x8	10	0	50 ^{+0,039 -0}	128	M4 x 16	M12 x 40	38
P _{max}	Maximum width of motor (end view) excluding terminal housing etc.								BB _{max}	Maximum height of pilot of mounting flange of motor						D	Distance between end of shaft and key						
A	Motor length without shaft, pilot, mating connector								øBF	Clearance hole in mounting flange of motor						BC	Distance between mounting flange of motor to shoulder on shaft (always =0 mm)						
B	Additional length of motor for motors with brake								XD	Usable length of keyseat						øE	Diameter of hole for shaft in flange of motor						
C	Thickness of flange plate of motor								R	Bottom of keyseat to opposite side of shaft						F	Width of motor between recesses for mounting screws						
øAJ	Diameter of mounting bolt circle in flange of motor								S1	Width of key						G	Thread in motor shaft (type and length)						
øAK	Diameter of pilot on flange of motor								S2	Height of key						H	Recommended fixing screws (type and length)						
AH	Mounting surface of flange of motor to end of shaft																						
øU	Diameter of shaft extension																						

All dimensions without tolerance are according to DIN ISO 2768, part 1, category c

Table 7.7

**Draufsicht auf Welle /
Front view on shaft**

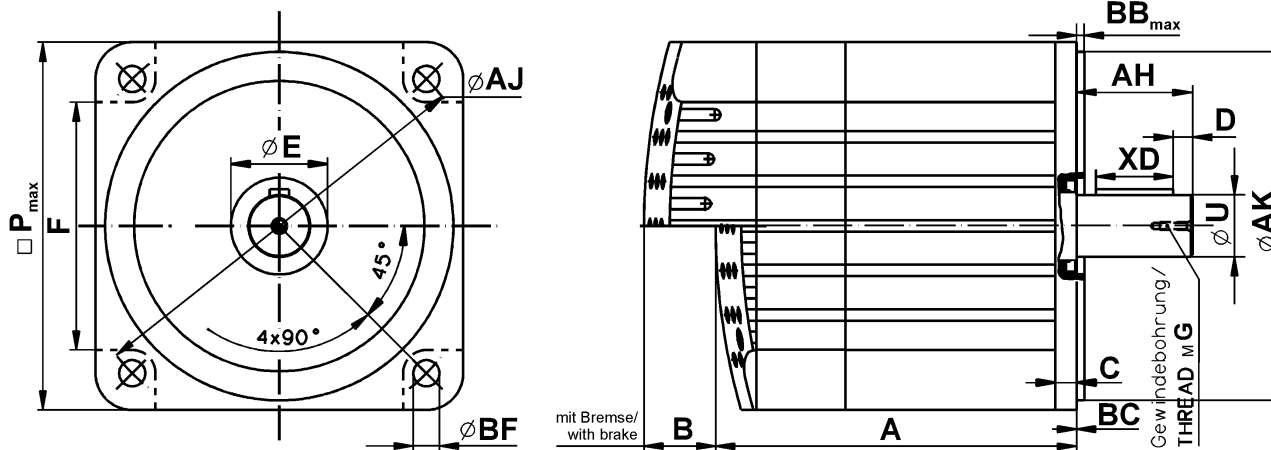
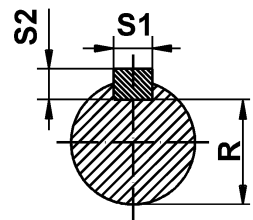

Additional dimensions, e.g. for connectors and mating connectors can be found in the catalogue.

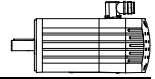

7.4 Installation instructions

7.4.1 Safety instructions

7.4.1.1 Explanation of symbols used



Important!

The symbol on the left and the word "Important" are used to draw attention to safety instructions concerning a potential **hazard for persons**.

Failure to comply with these safety instructions can result in serious damage to health and can even prove fatal in extreme cases.

These safety instructions must be observed without fail.



Warning:

The symbol on the left and the word "Warning!" are used to draw attention to instructions concerning potential **damage to the servo drive or to the system as a whole**.

Such warnings must be observed without fail.



Note:

Notes contain useful information for the operator when starting up and operating the system.



Danger - High voltage (Sticker on the power supply and servomotor)

The symbol on the left indicates that the power supply operates with high voltages which can prove extremely dangerous if touched.



Beware of hot parts (Sticker on servomotor)

In extreme applications, the surface of the servomotor may heat up to more than 100 °C and can cause skin burns if touched. The servomotor must therefore be protected to prevent contact.



Delicate part (Sticker on servomotor)

A hammer must not be used to force the gearing / gear wheel onto the shaft when installing such parts. The screw thread in the center of the shaft must be used for this purpose. An extractor supported on the center of the shaft must be used when dismantling the parts.

7.4.1.2 Qualified personnel



Important!

The components making up the drive system may only be installed and serviced by duly qualified personnel. The accident prevention regulations (UVV VBG 4, VDE 100, VDE 105) and the installation regulations (EN 60204 Part 1, prEN 50178) must be taken into account.

Unqualified work on the drive components and failure to comply with the warnings contained in this manual or affixed to the components can result in serious physical injury or damage to property.

The work permitted within the scope of this manual may consequently only be undertaken by duly qualified personnel.

This includes the following people:

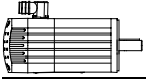

- **Planning and engineering design personnel** familiar with the safety guidelines for measurement and control instrumentation.
- **Operating personnel** who have been duly instructed with regard to the handling of measurement and control instrumentation and who are familiar with the operating instructions contained in this manual.
- **Commissioning and service personnel** authorized to start up, ground and mark the circuits for components and systems in accordance with safety engineering standards.

7.4.1.3 Intended use

The drive components have been developed and built for installation and operation in industrial systems.

7.4.1.4 List of safety instructions



Danger - High voltage!

The servo drives operate with potentially lethal voltages.

For this reason:

- **Disconnect the system from the mains supply.**
Before starting any work on the drive system, it must be disconnected from the power supply and secured against inadvertent reconnection by means of the master switch.
- **The servomotors must come to a complete stop.**
Rotating servomotors can generate potentially lethal voltages by acting as generators.



Beware of mechanical hazards!

Servomotors can accelerate highly dynamically. They also have enormous torque. The following points must therefore be noted when starting the system.

- **The danger zone of the motor must be cordoned off.**
The system must feature a guard door preventing personnel from reaching into or entering the danger zone. The drive system must be de-energized automatically as soon as the guard door is opened.
- The motor may accelerate inadvertently on account of wiring faults or software errors. Appropriate safety precautions must therefore be taken in the system to ensure that neither personnel nor machine components are endangered in any way.

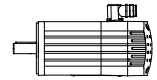

7.4.2 Mechanical installation

MOOG recommends that hexagon socket head screws to DIN 192 8.8 (see column H in Table 7.5) be used to secure the motor. Assembly is made very much easier by using an Allen key with ball head, particularly in the cases of motor sizes 2 and 3. The screws used to install these motor sizes must not be more than 40 mm long.

MOOG motors can become very hot in operation. Good heat dissipation must therefore be ensured when installing the motor, i.e. it should be flanged onto a suitably solid metal part of the machine. Adequate convection must also be ensured. In individual cases, the motor must furthermore be protected against contact due to the risk of burns. Forced cooling (e.g. with fans) will increase the continuous power, while bad convection may decrease the continuous performance.

Before connecting a coupling to the motor shaft, the latter must be thoroughly degreased. When using a degreasing agent, care must be taken to prevent it from entering the bearing. Otherwise the latter's permanent lubrication can no longer be guaranteed. We recommend the use of a clamp coupling or shrink connection to ensure reliable torque transmission. An inexpensive and service friendly connection is possible with the slot and key option (ensure tight slot tolerances).

Impermissibly high axial and radial forces on the shaft can result in motor damage during installation. The service life of the motor is impaired if the bearing is damaged in any way. Adjusting the rotor shaft by force can impair the correct functioning of the optional brake to such an extent that it has little or no braking effect. Excessive pressure and impacts on the front end of the shaft and rear housing cover must therefore be avoided under all circumstances.



Warning:

The permissible axial and radial forces are **in all cases exceeded** by the pulses due to hammering.

Maximum permissible axial and radial forces for brushless MOOG servomotors during installation

Motor size	G4x2	G4x3	G4x4	G4x5	G4x6
Axial force ¹⁾	150N	150N	300N	400N	500N
Radial force ¹⁾	500N	500N	1000N	1600N	2000N
1): During installation. Lower loads apply for the rotating motor, see catalogue.					

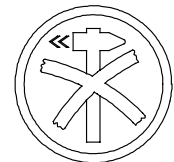
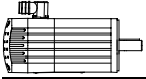

Table 7.8



7.4.3 Electrical interfaces

Use of the made-up cable sets is recommended for connecting the brushless MOOG servomotors. These cable sets are available in lengths of 10 (xxx = 010) and 20 meters (xxx = 020). If MOOG cables are not used, the values specified below with regard to the cable make-up must be maintained **in all cases**.



Warning:

A rotating motor can generate dangerously high voltages. Always make sure that there are no exposed cables.



Warning:

The servocontroller must always be switched off when assembling or disassembling a plug connector. Simply disabling of the servocontroller is not sufficient. Particular care must be taken to ensure installation of a protective earth conductor in conformity with the applicable safety regulations.



Note:

Small conductor cross-sections can cause the temperature of the cable to rise impermissibly. This may result in loss of power, particularly when using long cables.



Note:

For installation of cables, we recommend the power and signal cables be shielded. The shield must be grounded at both ends.

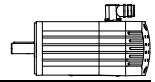

7.4.3.1 Pin assignment and cable details

The pin assignment of the connectors is illustrated in the following diagram.

Pin assignment for power cable and mating plug

(Top view of motor flange socket, mating connector mirrored):

Pin layout	Pin connection	Motor reference	Part number power cables ready-to-connect	Part number mating power connector loose	Part number power cable loose	Cable layout
	1 Phase W 2 Phase U 4 Phase V 5 24V Brake + 6 24V Brake - ⊕ PE	G4x2 G4x3 G4x4	B47914 001 xxx ①	A63472 001	B47890 001	4x1,5mm ² power, 2x1,0mm ² brake (separate shield), outer shield
	U Phase U V Phase V W Phase W + 24V Brake + - 24V Brake - ⊕ PE	G4x5	B47915 001 xxx ①	B47736 001	B47903 001	4x2,5mm ² power, 2x1,0mm ² brake (separate shield), outer shield
	U Phase U V Phase V W Phase W + 24V Brake + - 24V Brake - ⊕ PE	G4x6	B47916 001 xxx ①	B47711 001	B47904 001	4x10mm ² power, 2x1,0mm ² brake (separate shield), outer shield

Table 7.9

Pin assignment for signal cable and mating plug

(Top view of motor flange socket, mating connector mirrored):

Pin layout	Pin connection	Motor reference	Part number signal cables ready-to-connect	Part number mating signal connector loose	Part number signal cable loose	Cable layout
	1 S1 2 S3 3 S2 4 S4 5 NTC 6 NTC 7 R1 8 R2 9 - 12n.c.	G4x2 G4x3 G4x4 G4x5 G4x6	D-Sub-connector (Servocontroller T161) B47886 001 xxx ① multicore cable end (Servocontroller T164) B47886 002 xxx ①	A63021 001	B47885 001	4x2x0,25mm ² stranded wires, twisted paired, outer shield

Table 7.10

① - xxx is cable length in meters.

Standard lengths: xxx = 010 cable length 10 m.

xxx = 020 cable length 20 m.



7.5 Partnumber cross reference

The order number for motors is made up as follows:

G4xx - xxxR

Global Product _____

Series 4xx _____

Configuration _____

Code	
0	Special design (s. note) *)
1	US
2	Europe

*) Model numbers are defined consecutively for special (customized) motors. The line number consequently does not give any indication of the model properties. These are defined by the Model Master File.

Frame Size _____

Code	
2	55 mm Flange
3	70 mm Flange
4	100 mm Flange
5	140 mm Flange
6	190 mm Flange

Revision Index _____

Configuration of shaft extension

Code	Run Out	Shaft Type	Shaft Sealing
4	Reduced	Key	No
5	Reduced	Key	Yes
6	Reduced	Plain	No
7	Reduced	Plain	Yes

Brake Options

Code	G4x2	G4x3	G4x4	G4x5	G4x6
0	-	-	-	-	-
1	0.9 Nm	1.5 Nm	6 Nm	15 Nm	25 Nm
2	-	3 Nm	15 Nm	25 Nm	50 Nm

Active Length (in 0.1 inch)

Code	G4x2	G4x3	G4x4	G4x5	G4x6
2	L05	L05	L05	L10	L15
4	L10	L15	L10	L20	L30
6	L20	L25	L20	L30	L45
8	L40	L40	L40	L50	L60

Table 7.11

7.6 If repairs are required

Since correct disassembly cannot be guaranteed by MOOG, all the attachments not fitted by MOOG, such as gearboxes, gear wheels, pinions, etc. must be dismantled if a brushless MOOG servomotor has to be repaired. Any dirt on the front flange of the motor must also be removed. Repairs by external personnel are excluded for reasons associated with product liability, since the applicable safety regulations (e.g. VDE guidelines) and MOOG quality standards normally cannot be met by the customer. **All warranty rights are voided if the sealing varnish on the screws of the servomotors is broken.** If at all possible, a detailed description of the fault or failure should be enclosed with the shipping documents. The words "For repair" should feature prominently on the delivery note. The motor must be packed so that it is protected against knocks and bumps, as well as against damage in transit. Especially the shaft and connectors have to be protected. Please send the motor to your regional branch or one of the following service centers:

<p>Europe and Asia MOOG GmbH Hanns-Klemm-Straße 28 71034 Böblingen Germany Telephone: +0049 - 7031 - 622 - 0 Fax: +0049 - 7031 - 622 - 100</p>	<p>America MOOG Inc. / NADO Division Jamison Road EAST AURORA, NY 14052 U.S.A. Telephone: +001 - 716 - 687 - 2000 Fax: +001 - 716 - 687 - 4870</p>
---	---

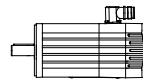

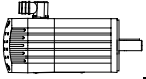

8 Maintenance and Service

8.1 Maintenance instructions	3
8.2 If repairs are required.....	3

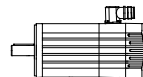

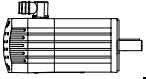

8.1 Maintenance instructions

The electronic components and servomotors do not require maintenance.

8.2 If repairs are required

Repairs by external personnel are excluded for reasons associated with product liability, since the applicable safety regulations (e.g. VDE guidelines) and MOOG quality standards cannot normally be met by the customer.

All warranty rights are extinguished if the sealing varnish on the screws of the servomotors is destroyed.

Defective components should be returned to MOOG.

Please use the form overleaf when returning components.

Do not attempt to repair the components yourself.

All warranty rights are extinguished if any attempt is made to repair components without authorization.

Repair order



To: MOOG GmbH - Repair-Center - Hanns-Klemm-Str. 28 D-71034 Böblingen Germany	Tel.: +0049 - 7031 - 622 - 191 Fax: +0049 - 7031 - 622 - 100
From: Company : _____ Tel: _____ Name : _____ Fax: _____ P.O.Box : _____ Street : _____ Town : _____ Country : _____	

The following components have been sent back to MOOG to be repaired:

<input type="checkbox"/> 19" rack with 6-axis backplane:	Model No.: _____	Serial No.: _____
<input type="checkbox"/> Backplane:	Model No.: _____	Serial No.: _____
<input type="checkbox"/> Power supply unit:	Model No.: _____	Serial No.: _____
<input type="checkbox"/> Servocontroller:	Model No.: _____	Serial No.: _____
<input type="checkbox"/> MCO Module (only for T161-00x):	Model No.: _____	
<input type="checkbox"/> Ballast resistor:	Model No.: _____	
<input type="checkbox"/> Servomotor:	Model No.: _____	Serial No.: _____
<input type="checkbox"/> Power cable:	Model No.: _____	
<input type="checkbox"/> Signal cable:	Model No.: _____	

How often does the fault occur? always sporadically after _____ hours

When did the fault occur for the first time? <input type="checkbox"/> During on-going operation <input type="checkbox"/> When switching on again after a break <input type="checkbox"/> When commissioning a new system (Check wiring first, measure voltages, is enable signal present, check limit switches and controller parameters) <input type="checkbox"/> When switching on again after maintenance work (Check that cables have not been connected incorrectly)	Which LEDs lit up (please X as appropriate)? <table style="width: 100%;"> <tr> <td style="width: 50%; vertical-align: top;"> On the PSU <input type="checkbox"/> <input type="checkbox"/> ±15V +5V <input type="checkbox"/> <input type="checkbox"/> >400V <input type="checkbox"/> <input type="checkbox"/> 3~ </td> <td style="width: 50%; vertical-align: top;"> On the servocontroller <div style="border: 1px solid black; padding: 5px; width: fit-content; margin: 0 auto;"> <input type="checkbox"/> <input type="checkbox"/> <input checked="" type="checkbox"/> </div> </td> </tr> </table>	On the PSU <input type="checkbox"/> <input type="checkbox"/> ±15V +5V <input type="checkbox"/> <input type="checkbox"/> >400V <input type="checkbox"/> <input type="checkbox"/> 3~	On the servocontroller <div style="border: 1px solid black; padding: 5px; width: fit-content; margin: 0 auto;"> <input type="checkbox"/> <input type="checkbox"/> <input checked="" type="checkbox"/> </div>
On the PSU <input type="checkbox"/> <input type="checkbox"/> ±15V +5V <input type="checkbox"/> <input type="checkbox"/> >400V <input type="checkbox"/> <input type="checkbox"/> 3~	On the servocontroller <div style="border: 1px solid black; padding: 5px; width: fit-content; margin: 0 auto;"> <input type="checkbox"/> <input type="checkbox"/> <input checked="" type="checkbox"/> </div>		

Description of the problem (Please give as many details as possible; use a separate sheet if necessary)

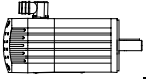

MOOG

