

USER MANUAL FOR

# DIRECT-OPERATED SERVO AND PROPORTIONAL VALVES WITH INTEGRATED DIGITAL ELECTRONICS

SERIES D637K AND D639K / SIZE 05



Rev. -, May 2012

SERVO AND PROPORTIONAL VALVES FOR ELECTROHYDRAULIC  
POSITION, SPEED, PRESSURE AND FORCE CONTROL EVEN FOR HIGH  
DYNAMIC REQUIREMENTS

## Copyright

© 2012 Moog GmbH  
Hanns-Klemm-Strasse 28  
71034 Boeblingen (Germany)  
Telephone: +49 7031 622-0  
Fax: +49 7031 622-100  
E-Mail: [Info.germany@moog.com](mailto:Info.germany@moog.com)  
Internet: <http://www.moog.com/industrial>

All rights reserved.

No part of this user manual may be reproduced in any form (print, photocopies, microfilm, or by any other means) or edited, duplicated, or distributed with electronic systems without the prior written consent of Moog.

Offenders will be held liable for the payment of damages.

Subject to change without notice.

# Table of Contents

Index of Tables .....	vii
Index of Figures .....	vii
<b>1 General Information .....</b>	<b>1</b>
<b>1.1 Notes on user manual .....</b>	<b>1</b>
1.1.1 Subject to change without notice and validity.....	1
1.1.2 Completeness .....	2
1.1.3 Storage location .....	2
1.1.4 Typographical conventions.....	3
1.1.5 Structure of the warning notes .....	4
<b>1.2 Supplemental documents .....</b>	<b>5</b>
<b>1.3 Intended operation .....</b>	<b>5</b>
<b>1.4 Selection and qualification of personnel .....</b>	<b>7</b>
<b>1.5 Structural modifications .....</b>	<b>7</b>
<b>1.6 Environmental protection .....</b>	<b>8</b>
1.6.1 Acoustical Emissions.....	8
1.6.2 Disposal.....	9
<b>1.7 Responsibilities .....</b>	<b>10</b>
<b>1.8 Warranty and liability .....</b>	<b>11</b>
<b>1.9 Declaration of conformity .....</b>	<b>12</b>
<b>1.10 Registered marks and trademarks.....</b>	<b>13</b>
<b>2 Safety .....</b>	<b>14</b>
<b>2.1 Handling in accordance with safety requirements.....</b>	<b>14</b>
<b>2.2 Occupational safety and health .....</b>	<b>15</b>
<b>2.3 General safety instructions .....</b>	<b>16</b>
<b>2.4 ESD .....</b>	<b>16</b>
<b>2.5 Pressure limitation .....</b>	<b>16</b>
<b>3 Product Description.....</b>	<b>17</b>
<b>3.1 Function and mode of operation.....</b>	<b>17</b>
3.1.1 Operational modes .....	17
3.1.2 Representative depiction of the valve .....	18
3.1.3 Permanent magnet linear force motor.....	19
3.1.4 Valve electronics and valve software .....	19
3.1.4.1 Valve status.....	20
3.1.5 Signal interfaces.....	21
3.1.5.1 Connector X1 .....	22
3.1.5.2 Field bus connectors X3 and X4 .....	22
3.1.5.3 Service connector X10 .....	23
<b>3.2 Safety function/fail-safe .....</b>	<b>24</b>
3.2.1 Mechanical fail-safe function .....	25
3.2.1.1 Valves with fail-safe function F, D or M .....	25
3.2.1.2 Mechanical fail-safe state .....	25
3.2.1.3 Fail-safe identification.....	25
3.2.1.4 bushing-spool identification .....	26
3.2.2 Electrical fail-safe function.....	26

3.2.3 Fail-safe events .....	27
3.2.3.1 Shutdown/failure of the supply voltage .....	27
3.2.3.2 Signals at the enable input .....	28
3.2.3.3 Settable fault reaction .....	28
3.2.3.4 Control commands .....	29
3.2.4 Restarting the valve .....	30
<b>3.3 Hydraulics .....</b>	<b>31</b>
3.3.1 Operational modes .....	31
3.3.1.1 Flow control (Q-control) .....	32
3.3.1.2 Pressure control (p-control) .....	32
3.3.1.3 Flow and pressure control (pQ-control) .....	34
3.3.2 Valve configurations and hydraulic symbols .....	35
3.3.2.1 4-way and 3-way operation .....	35
3.3.2.2 2-way and 2x2-way operation .....	36
3.3.3 Leakage port Y .....	36
3.3.3.1 Y identification .....	37
3.3.4 Electrical and hydraulic zero positions .....	37
3.3.5 Notes on the pressure controller control response (D639K) .....	38
<b>3.4 Control .....</b>	<b>39</b>
3.4.1 Signal types for analog command inputs .....	40
3.4.1.1 Signal type identification .....	41
3.4.1.2 Flow control command inputs .....	42
3.4.1.3 Pressure control command inputs .....	45
3.4.2 Analog actual value outputs 4–20 mA .....	48
3.4.2.1 Spool position actual value output .....	48
3.4.2.2 Pressure actual value output .....	48
3.4.3 Digital enable input .....	48
<b>3.5 Valve software .....</b>	<b>49</b>
<b>3.6 Moog Valve and Pump Configuration Software .....</b>	<b>50</b>
<b>3.7 Nameplate .....</b>	<b>50</b>
<b>4 Characteristic curves .....</b>	<b>51</b>
<b>4.1 Flow diagram (4-way operation) .....</b>	<b>51</b>
<b>4.2 Flow signal characteristic curve .....</b>	<b>52</b>
<b>4.3 Pressure signal characteristic curves .....</b>	<b>52</b>
4.3.1 Valves with controlled spool position .....	52
4.3.2 Pressure control valves .....	53
<b>4.4 Step response and frequency response .....</b>	<b>54</b>
<b>5 Transportation and Storage .....</b>	<b>58</b>
5.1 Checking/unpacking a delivery .....	60
5.2 Scope of delivery of the valve .....	60
5.3 Storage .....	60
<b>6 Mounting and Connection to the Hydraulic System .....</b>	<b>61</b>
<b>6.1 Dimensions (installation drawings) .....</b>	<b>63</b>
<b>6.2 Mounting surface .....</b>	<b>64</b>
6.2.1 Surface quality .....	64
6.2.2 Mounting pattern of mounting surface .....	64
<b>6.3 Mounting the valve .....</b>	<b>65</b>
6.3.1 Tools and materials required .....	65
6.3.2 Specification for installation screws .....	65
6.3.3 Procedure .....	66

<b>7 Electrical connection</b>	<b>68</b>
<b>7.1 Safety instructions for installation and maintenance</b>	<b>68</b>
7.1.1 Protective grounding and electrical shielding	71
7.1.2 Moog Valve and Pump Configuration Software	72
<b>7.2 Block diagram</b>	<b>73</b>
<b>7.3 Arrangement of connectors</b>	<b>74</b>
<b>7.4 Connector X1</b>	<b>76</b>
7.4.1 Pin assignment of connector X1	76
7.4.2 Mating connector for connector X1	76
7.4.3 Power supply	77
<b>7.5 Analog inputs/outputs</b>	<b>77</b>
7.5.1 Analog inputs	77
7.5.1.1 Signal types	78
7.5.2 Analog outputs	80
<b>7.6 Digital inputs/outputs</b>	<b>81</b>
7.6.1 Digital inputs	81
7.6.2 Digital outputs	81
<b>7.7 Digital signal interface</b>	<b>82</b>
7.7.1 SSI transducer	82
7.7.1.1 Pin assignment SSI transducer connector X2	83
<b>7.8 Field bus connectors X3 and X4</b>	<b>84</b>
7.8.1 CAN connectors	84
7.8.1.1 Technical data for the CAN bus interface	84
7.8.1.2 Pin assignment, CAN connectors	85
7.8.2 Profibus-DP connectors	85
7.8.2.1 Technical data for the Profibus-DP interface	86
7.8.2.2 Pin assignment, Profibus-DP connectors	87
7.8.3 EtherCAT connectors	87
7.8.3.1 Technical data for the EtherCAT interface	88
7.8.3.2 Pin assignment, EtherCAT connectors	89
<b>7.9 Analog input connectors X5, X6 and X7</b>	<b>90</b>
7.9.1 Pin assignment, analog input connectors X5, X6 and X7	90
7.9.2 Signal types	91
7.9.3 Input resistances	92
<b>7.10 Service connector X10</b>	<b>93</b>
<b>7.11 General notes on wiring</b>	<b>95</b>
7.11.1 Tools and materials required	95
7.11.2 Procedure	96
7.11.3 Wiring supply cables and digital and analog signals	96
<b>7.12 Protective grounding and electrical shielding</b>	<b>97</b>
7.12.1 Overview	97
7.12.2 Equipotential bonding and protective grounding	98
7.12.2.1 General principles	99
7.12.2.2 Protective conductor	100
7.12.2.3 Ground loops	100
7.12.3 Machines with deficient equipotential bonding	101
7.12.4 Electrical shielding	101
7.12.4.1 Cables	101
7.12.4.2 Connecting the shield	102
7.12.4.3 Insulated shielding	104
7.12.4.4 Cable routing	105
<b>7.13 Permissible lengths for connection cables</b>	<b>105</b>
7.13.1 Introduction	105

7.13.2 Typical values for copper cables .....	105
7.13.2.1 Resistance of cable .....	105
7.13.2.2 Capacitance of cable .....	105
7.13.3 24V supply cables .....	106
7.13.3.1 Voltage drop per unit length .....	107
7.13.3.2 Examples of the voltage drop of supply cables .....	107
7.13.4 Analog signal cables .....	108
7.13.5 Digital signal cables .....	109
7.13.5.1 Digital signal input cables .....	109
7.13.5.2 Digital signal output cables .....	109
7.13.5.3 Field bus cables .....	109
<b>7.14 Wiring connector X1 .....</b>	<b>110</b>
7.14.1 Single-ended command signals .....	110
7.14.2 Conversion of actual value output signals $I_{out}$ .....	111
7.14.2.1 Valves with 7-pin connector X1 .....	111
<b>7.15 Wiring SSI transducers (X2) .....</b>	<b>112</b>
7.15.1 SSI master mode .....	112
<b>7.16 Wiring CAN networks .....</b>	<b>113</b>
7.16.1 Cable lengths and cable cross sections .....	116
7.16.1.1 Suitable cable types for CAN networks .....	116
7.16.2 Permissible number of CAN bus nodes .....	117
7.16.3 CAN module address (node ID) .....	117
7.16.4 CAN transmission rate .....	117
<b>7.17 Wiring Profibus-DP networks (X3, X4) .....</b>	<b>118</b>
7.17.1 Cable lengths and cable cross sections .....	119
7.17.1.1 Suitable cable types for Profibus-DP networks .....	120
7.17.2 Permissible number of Profibus nodes .....	120
7.17.3 Profibus-DP module address (node ID) .....	120
7.17.4 Profibus-DP transmission rate .....	120
<b>7.18 Wiring EtherCAT networks (X3, X4) .....</b>	<b>121</b>
7.18.1 Suitable cable types for EtherCAT networks .....	122
7.18.2 Permissible number of EtherCAT nodes .....	123
7.18.3 EtherCAT module address (node ID) .....	123
7.18.4 EtherCAT transmission rate .....	123
<b>7.19 Wiring analog inputs (X5, X6, X7) .....</b>	<b>124</b>
<b>7.20 Electrical start-up .....</b>	<b>126</b>
<b>7.21 Electromagnetic compatibility (EMC) .....</b>	<b>127</b>
<b>7.22 Communication via the Moog Valve and Pump Configuration Software .....</b>	<b>128</b>
<b>8 Start-up .....</b>	<b>130</b>
<b>8.1 Preparations .....</b>	<b>135</b>
<b>8.2 Start-up of the valves .....</b>	<b>136</b>
<b>8.3 Configuration of the valves .....</b>	<b>136</b>
8.3.1 Configuration via the field bus interface .....	137
8.3.1.1 Configuration with the machine controller .....	137
8.3.1.2 Configuration with the Moog Valve and Pump Configuration Software .....	138
8.3.2 Configuration via the service interface .....	139
8.3.3 Factory setting of the valves .....	140
8.3.4 Storing of parameters .....	140
<b>8.4 Filling and flushing the hydraulic system .....</b>	<b>141</b>
<b>8.5 Start-up of the hydraulic system .....</b>	<b>142</b>
8.5.1 Venting .....	142
8.5.1.1 Tool required .....	143
8.5.1.2 Venting the valve and the actuator .....	143

<b>9 Operation</b>	<b>144</b>
9.1 Preparations for operation	147
9.2 Operation of the valve	148
9.3 Shutting down the valve	149
<b>10 Service</b>	<b>151</b>
10.1 Removing of the valves	155
10.1.1 Tools and materials required	155
10.1.2 Removing	156
10.2 Maintenance	156
10.2.1 Checking and replacing the port O-rings	157
10.2.1.1 Tools and materials required	157
10.2.1.2 checking and replacing the O-rings	157
10.2.2 Monitoring the pressure transducer drift	158
10.3 Trouble shooting	158
10.3.1 Leaks	159
10.3.1.1 Leak at the valve connecting surface	159
10.3.1.2 Leak at the linear force motor screw plug	159
10.3.1.3 Leak at the venting screw	159
10.3.2 No hydraulic response by the valve	160
10.3.3 Instability of the external control loop	161
10.3.4 Instability of the internal valve control loops	161
10.3.4.1 Flow control	161
10.3.4.2 Pressure control	161
10.4 Repair	162
<b>11 Technical Data</b>	<b>164</b>
11.1 Nameplates	165
11.1.1 Model number	167
11.1.2 LSS address (Layer Setting Services)	167
11.1.3 Data matrix code	167
11.2 General technical data	168
11.3 Hydraulic data	169
11.3.1 Pressure range identification	170
11.4 Static and dynamic data	170
11.5 Electrical data	171
11.5.1 Electromagnetic compatibility (EMC)	172
<b>12 Accessories and spare parts</b>	<b>173</b>
12.1 Accessories	173
12.2 Spare parts	175
12.3 Tools for valves in the D637K and D639K type series	175
<b>13 Ordering Information</b>	<b>176</b>
<b>14 Keyword index</b>	<b>178</b>
<b>15 Appendix</b>	<b>190</b>
15.1 Abbreviations, symbols and identification letters	190
15.2 Additional literature	192
15.2.1 Fundamentals of hydraulics	192
15.2.2 CAN fundamentals	192

15.2.3 Profibus fundamentals.....	192
15.2.4 EtherCAT fundamentals.....	193
15.2.5 Moog publications .....	193
<b>15.3 Quoted standards .....</b>	<b>193</b>
15.3.1 CiA DSP .....	193
15.3.2 TIA/EIA.....	193
15.3.3 IEC .....	193
15.3.4 IEEE .....	193
15.3.5 ISO, ISO/IEC .....	194
15.3.6 DIN .....	194
15.3.7 EN .....	194
15.3.8 EN ISO .....	195
15.3.9 ISO .....	196
<b>15.4 Quoted directives .....</b>	<b>196</b>
<b>15.5 Explosion-proof connectors.....</b>	<b>196</b>



# Index of Tables

Tab. 1: Identification D637K-R/D639K-R .....	5
Tab. 2: Identification D637K-P/D639K-P .....	5
Tab. 3: Operational modes of the valves .....	17
Tab. 4: Valve status .....	20
Tab. 5: Existing interfaces.....	21
Tab. 6: Spool .....	25
Tab. 7: Specification for installation screws .....	65
Tab. 8: Allocation of interfaces to connectors .....	75
Tab. 9: Technical data for the CAN bus interface .....	84
Tab. 10: Technical data for the Profibus-DP interface .....	86
Tab. 11: Technical data for the EtherCAT interface.....	88
Tab. 12: Input resistances X5, X6, X7 .....	92
Tab. 13: Benefits of the different signal types for analog inputs .....	96
Tab. 14: Examples of the voltage drop of supply cables as a function of the cable length for a cable cross section of 0.75 m <sup>2</sup> .....	107
Tab. 15: Recommendation for maximum cable lengths in CAN networks, depending on the transmission rate .....	116
Tab. 16: Recommendation for maximum cable lengths in CAN networks, depending on the cable cross section and the number n of CAN bus nodes .....	116
Tab. 17: Maximum permissible stub cable lengths in CAN networks .....	116
Tab. 18: Specification of electrical data for CAN bus cables .....	116
Tab. 19: Suitable cable types for CAN networks .....	116
Tab. 20: Recommendation for maximum cable lengths in Profibus-DP networks, depending on the transmission rate .....	119
Tab. 21: Specification of electrical data for Profibus-DP cables (as per type A).....	120
Tab. 22: Suitable cable types for Profibus-DP networks.....	120
Tab. 23: Assignment of Ethernet/EtherCAT signals with mixed connector types .....	122
Tab. 24: General technical data.....	168
Tab. 25: Hydraulic data.....	169
Tab. 26: Pressure range identification in the type designation .....	170
Tab. 27: Static and dynamic data .....	170
Tab. 28: Electrical data .....	171
Tab. 29: Accessories .....	173
Tab. 30: Spare parts .....	175
Tab. 31: Spare parts for valves in the D67XK type series .....	175
Tab. 32: Abbreviations, symbols and identification letters .....	190

# Index of Figures

Fig. 1:	Representative depiction of a direct drive servo valve .....	18
Fig. 2:	Representative depiction of a permanent magnet linear force motor .....	19
Fig. 3:	Flow control (Q-control) block diagram .....	32
Fig. 4:	Pressure control (p-control) block diagram .....	33
Fig. 5:	Flow and pressure control (pQ-control) block diagram .....	34
Fig. 6:	4-way operation with mechanical fail-safe function M (hydraulic symbol) .....	35
Fig. 7:	3-way operation with mechanical fail-safe function M (hydraulic symbol) .....	35
Fig. 8:	2-way operation with mechanical fail-safe function M (hydraulic symbol) .....	36
Fig. 9:	2x2-way operation with mechanical fail-safe function M (hydraulic symbol) .....	36
Fig. 10:	Examples of the electrical and hydraulic zero positions of different spools in the flow signal characteristic curve .....	37
Fig. 11:	Differential flow control command input $\pm 10$ V (circuit and characteristic curve) .....	42
Fig. 12:	Differential flow control command input $\pm 10$ mA (circuit and characteristic curve) .....	43
Fig. 13:	Differential flow control command input 4–20 mA (circuit and characteristic curve) .....	44
Fig. 14:	Differential flow control command input 0–10 V (circuit and characteristic curve) .....	45
Fig. 15:	Differential flow control command input 0–10 mA (circuit and characteristic curve) .....	46
Fig. 16:	Differential flow control command input 4–20 mA (circuit and characteristic curve) .....	47
Fig. 17:	Flow diagram (4-way operation) .....	51
Fig. 18:	Flow signal characteristic curve with equal electrical and hydraulic zero positions .....	52
Fig. 19:	Design for measuring the flow signal characteristic curve .....	52
Fig. 20:	Pressure signal characteristic curve of the valves with controlled spool position and zero lap .....	52
Fig. 21:	Design for measuring the pressure signal characteristic curve on valves with controlled spool position .....	52
Fig. 22:	Pressure characteristic curve of the pressure control valves .....	53
Fig. 23:	Design for measuring the pressure signal characteristic curve on pressure control valves .....	53
Fig. 24:	Step response of the spool stroke for valves with $Q_N = 60$ l/min (16 gpm) .....	54
Fig. 25:	Step response of the spool stroke for valves with $Q_N = 100$ l/min (26 gpm) .....	54
Fig. 26:	Step response of the spool stroke for valves with $Q_N = 80$ l/min (26 gpm) .....	55
Fig. 27:	Frequency response of the spool stroke for valves with $Q_N = 60$ l/min (16 gpm) .....	56
Fig. 28:	Frequency response of the spool stroke for valves with $Q_N = 80$ l/min with $\Delta p = 5$ bar .....	56
Fig. 29:	Frequency response of the spool stroke for valves with $Q_N = 100$ l/min (26 gpm) .....	57
Fig. 30:	Installation drawing for valves with CAN bus interface (dimensions in mm) .....	63
Fig. 31:	Hole pattern of the mounting surface according to <a href="#">ISO 4401-05-05-0-05</a> , dimensions in mm and (in) .....	64
Fig. 32:	Block diagram of the valve electronics .....	73
Fig. 33:	Arrangement of connectors on the valve electronics housing (maximum equipment specification) .....	74
Fig. 34:	Pin assignment connector X1 (7-pin) p/Q valves .....	76
Fig. 35:	Pin assignment connector X1 (7-pin) Q valves .....	76

Fig. 36: SSI transducer connector X2 (6+PE-pin) .....	83
Fig. 37: CAN connectors X3 and X4.....	85
Fig. 38: Profibus DP connectors X3 and X4.....	87
Fig. 39: EtherCAT connectors X3 and X4 .....	89
Fig. 40: Analog input connectors X5, X6 and X7.....	90
Fig. 41: Equivalent circuit diagram of analog input.....	92
Fig. 42: Service connector X10 (M8, 3-pin).....	93
Fig. 43: Equipotential bonding and protective grounding of machines (see also <a href="#">EN 60204-1</a> ) and electrical shielding of our valves with integrated electronics .....	98
Fig. 44: Connecting the shield to the control cabinet's wall (detail A from fig. 43).....	102
Fig. 45: Connecting the cable shield via connector to the control cabinet's wall (detail A from fig. 43).....	103
Fig. 46: Connecting the insulated shielding to the control cabinet's wall (detail A from fig. 43) .....	104
Fig. 47: Voltage drop on the supply cable .....	107
Fig. 48: Wiring of the 7-pin connector X1 Q valve .....	110
Fig. 49: Wiring of the 7-pin connector X1 pQ valve .....	110
Fig. 50: Circuit for single-ended command signals.....	110
Fig. 51: Circuit for converting the actual value output signals $I_{out}$ (for valves with 7-pin connector X1) .....	111
Fig. 52: Wiring diagram with SSI transducer .....	112
Fig. 53: Signals between valve and a 16-bit SSI transducer (example) .....	112
Fig. 54: CAN wiring diagram.....	114
Fig. 55: Connection of the CAN bus valve with terminal resistor.....	114
Fig. 56: Connection of the valve to a PC via the CAN bus interface (field bus connector X3) .....	115
Fig. 57: Profibus-DP wiring diagram .....	119
Fig. 58: Connection valve Profibus with terminal resistor .....	119
Fig. 59: EtherCAT wiring diagram.....	122
Fig. 60: Twisted-pair litz wires in Ethernet/EtherCAT cables with M12 connectors.....	122
Fig. 61: Connecting a 2-wire transducer to analog input connectors X5, X6 or X7 .....	125
Fig. 62: Connecting a 3-wire transducer to analog input connectors X5, X6 or X7 .....	125
Fig. 63: Connecting a 4-wire transducer to analog input connectors X5, X6 or X7 .....	125
Fig. 64: Connection of the valve to a PC via the service interface (service connector X10) .....	139
Fig. 65: MOOG Global Support Logo .....	162
Fig. 66: Nameplate (example) .....	165
Fig. 67: Ex nameplate (example).....	166

# 1 General Information

## 1.1 Notes on user manual

This user manual refers exclusively to the standard models of the valves of the D637K/D639K type series. It includes the most important notes in order to operate these valves properly and safely.

⇒ Chap. "1.3 Intended operation", page 5

⇒ Chap. "2.1 Handling in accordance with safety requirements", page 14



Special models of the valves custom-made for specific customers, such as valves with axis control function (ACV), are not explained in this user manual.

Please contact Moog or one of its authorized service centers for information on these special models.

The contents of this user manual and the product-related hardware and software documentation relevant to the particular application must be read, understood and followed in all points by each person responsible for machine planning, assembly and operation before work with and on the valves is started. This requirement applies in particular to the safety instructions.

⇒ Chap. "1.1.2 Completeness", page 2

⇒ Chap. "1.4 Selection and qualification of personnel", page 7

⇒ Chap. "1.7 Responsibilities", page 10

⇒ Chap. "2.1 Handling in accordance with safety requirements", page 14

This user manual was created with great care and takes into account the applicable regulations, the state of technology, as well as our many years of knowledge and experience. The entire content has been formulated to the best of our knowledge.

However, the possibility of error remains and improvements are possible.

Please feel free to submit any comments about possible errors and incomplete information to us.



This user manual is also available in German.

On request, translation into other languages is possible.

### 1.1.1 Subject to change without notice and validity

The information contained in this user manual is valid and correct at the moment of release of this version of the user manual. The version number and release date of this user manual are indicated in the footer.

Changes may be made to this user manual at any time and without reasons being given.

**Notes on user manual**

**Subject to change without notice and validity of the user manual**

## 1.1.2 Completeness

This user manual is only complete in conjunction with the product-related hardware and software documentation required for the relevant application.

Available documentation:

⇒ [Chap. "1.2 Supplemental documents", page 5](#)

**Completeness of  
the user manual**

## 1.1.3 Storage location

This user manual together with all the product-related hardware and software documentation relevant to the particular application must at all times be kept close at hand to the valve or the higher-level machine.

**Storage location for  
the user manual**

## 1.1.4 Typographical conventions

### DANGER



warns about an imminent danger to health and life.  
Failure to observe this warning can cause severe injuries or even death.

- ▶ Make absolutely sure to heed the measures described to prevent this danger

### Typographical conventions

### WARNING



warns about a possible situation dangerous to health.  
Failure to observe this warning can cause severe injuries or even death.

- ▶ Make absolutely sure to heed the measures described to prevent this danger

### CAUTION



warns about a possible situation dangerous to health.  
Failure to observe this warning can cause slight injuries.

- ▶ Make absolutely sure to heed the measures described to prevent this danger

### CAUTION

warns about possible property and environmental damage.  
Failure to observe this warning can cause damage to the product, a machine or the environment.

- ▶ Make absolutely sure to heed the measures described to prevent this danger



Identifies important notes that contain usage tips and special useful information, but no warnings.

### Important

- or - Identifies listings
- ▶ Identifies an action that must be taken
- ⇒ Identifies references to another chapter, another table or figure
- "..." Denotes headings to the chapters or titles of the documents to which reference is being made
- Blue text Identifies hyperlinks
- 1., 2., ... Identifies steps in a procedure that must be performed in consecutive order
- '...!' Identifies parameters for valve software (e.g.: 'Node ID') or the valve status (e.g.: 'ACTIVE')

### 1.1.5 Structure of the warning notes

In the present user manual, danger symbols draw attention to remaining dangers in the handling of valves that cannot be constructively avoided. The actions for avoiding danger described must be adhered to.

The warning notes used are structured as follows:

<b>SIGNAL WORD</b>		<b>Structure of warning notes</b>
	<p><b>Type of danger</b> Consequences ▶ Prevention</p>	
<ul style="list-style-type: none"> <li>• <b>Warning symbol:</b> draws attention to the danger</li> <li>• <b>Signal word:</b> indicates the severity of the danger               <ul style="list-style-type: none"> <li>- Meaning of the signal words: ⇒ <a href="#">Chap. "1.1.4 Typographical conventions", page 3</a></li> </ul> </li> <li>• <b>Type of danger:</b> names the type and source of danger</li> <li>• <b>Consequences:</b> describes the consequences in case of non-observance</li> <li>• <b>Prevention:</b> specifies the actions to prevent this danger.</li> </ul>		<b>Explanation structure of warning notes</b>

## 1.2 Supplemental documents



The supplemental documents mentioned here are not included in the valves' scope of delivery. They are available as an accessory.  
⇒ [Chap. "12 Accessories and spare parts", page 173](#)

The PDF files of the supplemental documents can be downloaded from the following link:  
<http://www.moog.com/industrial/literature>

### Supplemental documents

The following supplemental documents are available:

- Application notes "Technical Note TN 353"  
Protective grounding and electrical shielding of hydraulic valves with integrated electronics

## 1.3 Intended operation



The valves may be operated exclusively within the framework of the data and applications specified in the user manual.  
Any other or more extensive use is not permitted.

### Intended operation

The valves of the type series D637K/D639K are electrical operating resources for areas subject to explosion, protection type "de" (d flameproof enclosure according to IEC 60079-1, e increased safety according to IEC 60079-7).

#### Identification of type series D637K-R/D639K-R:

D637K-R/D639K-R		II 2G Ex d e IIC TX Gb			
	TX	Temperature environment		Temperature hydraulic fluid	
Sealing material: FKM	T3	-20 °C	60 °C	-20 °C	80 °C
	T4	-20 °C	25 °C	-20 °C	25 °C
Sealing material: HNBR	T3	-20 °C	35 °C	-20 °C	35 °C
	T4	-20 °C	25 °C	-20 °C	25 °C
Sealing material: T-ECOPUR Temperature range down to -40 °C on request	T4	-40 °C	-5 °C	-40 °C	-5 °C

Tab. 1: Identification D637K-R/D639K-R

#### Identification type series D637K-P/D639K-P:

D637K-P/D639K-P		II 2G Ex d e IIC TX Gb			
	TX	Temperature environment		Temperature hydraulic fluid	
Sealing material: FKM	T3	-20 °C	60 °C	-20 °C	80 °C
	T4	-20 °C	60 °C	-20 °C	65 °C
	T5	-20 °C	35 °C	-20 °C	35 °C
Sealing material: HNBR	T4	-20 °C	60 °C	-20 °C	60 °C
	T5	-20 °C	35 °C	-20 °C	35 °C
Sealing material: T-ECOPUR Temperature range down to -40 °C on request	T5	-40 °C	20 °C	-40 °C	20 °C

Tab. 2: Identification D637K-P/D639K-P

The valves may only be operated as a component part of a higher-level overall system, for example in a machine.



They may be used only as control elements to control flow and/or pressure in hydraulic circuits that regulate position, speed, pressure and power.

The valves are intended for use with mineral-oil-based hydraulic oils. Use with other media requires our prior approval.

Correct, reliable and safe operation of the valves requires qualified project planning as well as proper utilization, transportation, storage, mounting, removal, electric and hydraulic connection, start-up, configuration, operation, cleaning and maintenance.

**The valves may only be started up when the following is ensured:**

- The higher-level machine with all its installed components complies with the latest versions of the relevant national and international regulations, standards and guidelines (such as, the EU Machinery Directive, the regulations of the trade association and of TÜV or VDE).
- The valves and all the other installed components are in a technically fault-free and operationally reliable state.
- No signals that can lead to uncontrolled movements in the machine are transmitted to the valves.

**Intended operation also includes the following:**

- Observation of this user manual
- Handling of the valves in accordance with safety requirements  
⇒ [Chap. "2.1 Handling in accordance with safety requirements", page 14](#)
- Adherence to all the inspection and maintenance instructions of the manufacturer and the operator of the machine
- Observation of all product-related hardware and software documentation relevant to the particular application
- Observation of all safety standards of the manufacturer and the operator of the machine relevant to the particular application
- Observation of all the latest versions of the national and international regulations, standards and guidelines relevant to the particular application (such as, the EU Machinery Directive, the regulations of the trade association and of TÜV or VDE)

## 1.4 Selection and qualification of personnel

### CAUTION

#### **Danger of personal injury and damage to property!**

Working with and on the valves without the required basic mechanical, hydraulic, and electrical knowledge may cause injuries or parts may be damaged.

- ▶ Only properly qualified and authorized users may work with and on the valves.
- ▶ ⇒ Chap. "1.4 Selection and qualification of personnel", page 7.

### Selection and qualification of personnel



Maintenance work by the user on explosion proof valves is not permitted. Intervention by third parties will invalidate the ex certification.

Qualified users are specialized personnel with the required knowledge and experience who have been trained to carry out such work. The specialized personnel must be able to recognize and avert the dangers to which they are exposed when working with and on the valves.

In particular, these specialized personnel must be authorized to operate, earth/ground and mark hydraulic and electrical devices, systems and power circuits in accordance with the standards of safety engineering. Project planners must be fully conversant with automation safety concepts.

Warranty and liability claims in the event of personal injury or damage to property are among others excluded if such injury or damage is caused when the valves are worked on or handled by non-qualified personnel.

⇒ Chap. "1.8 Warranty and liability", page 11

### Qualified users

## 1.5 Structural modifications

### CAUTION

#### **Risk of damage!**

The valves and the accessories can be damaged due to structural changes.

- ▶ Due to the complexity of the internal components, structural changes to the valves and to the accessories may only be made by MOOG GmbH or our authorized MOOG service centers.

### Structural modifications

### CAUTION

#### **Electrostatic discharge!**

To guarantee safe operation in hazardous area.

- ▶ The additional painting of our explosion-proof valves by third parties is a structural change. In case of additional painting, due to the possible accumulation of electrostatic charges, the corresponding provisions of the EN 60079-0 standard must be adhered to.

**DANGER****Danger of explosion!**

To guarantee safe operation in hazardous area:

- ▶ Structural modifications of the valves or to accessories may only be made by MOOG GmbH or by an authorized MOOG service center.
- ▶ Intervention by third parties will invalidate the ex certification.

Warranty and liability claims for personal injury and damage to property are excluded if they are caused by unauthorized or improperly performed structural modifications or other interventions.

⇒ [Chap. "1.8 Warranty and liability", page 11](#)

## 1.6 Environmental protection

### 1.6.1 Acoustical Emissions

**WARNING****Damage to hearing!**

Depending on the application, significant levels of noise may be generated when the valves are operated.

- ▶ Always protect yourself with hearing protection when working on the valves.

**Environmental protection:  
Acoustical Emissions**

Generally speaking, the valves do not generate harmful acoustical emissions when they are used for their intended purpose.

## 1.6.2 Disposal

### WARNING



#### Risk of injury!

In order to prevent injuries and other damage to health, please observe the following recommendations.

- ▶ Wear appropriate safety clothing.
- ▶ Wear protective gloves and safety glasses.
- ▶ ⇒ [Chap. "2.2 Occupational safety and health", page 15](#)

It is essential to comply with the relevant national waste disposal regulations and environmental protection provisions when disposing of valves, spare parts or accessories, packaging that is no longer needed, hydraulic fluid or auxiliary materials and substances used for cleaning!

If necessary, the items to be disposed of must be expertly dismantled into individual parts, separated into individual materials and placed in the corresponding waste system or earmarked for recycling.

The valve contains among others the following materials:

- Electronic components
- Adhesives and casting compounds
- Parts with electro-plated surfaces
- Permanent-magnet materials
- Hydraulic fluid
- Assorted metals and plastics

**Environmental  
protection: Disposal**

## 1.7 Responsibilities

The manufacturer and the operator of the machine are responsible for ensuring that work with and on the valves and handling of the valves is planned and performed in accordance with the directions given in this user manual and in the product-related hardware and software documentation relevant to the particular application.

The manufacturer and the operator of the machine are in particular responsible for ensuring the following:

- Selection and training of personnel  
⇒ [Chap. "1.4 Selection and qualification of personnel", page 7](#)
- Intended operation  
⇒ [Chap. "1.3 Intended operation", page 5](#)
- Handling in accordance with safety requirements  
⇒ [Chap. "2.1 Handling in accordance with safety requirements", page 14](#)
- Taking and monitoring of the occupational safety and health measures required for the particular application  
⇒ [Chap. "2.2 Occupational safety and health", page 15](#)
- Observation of all safety standards of the manufacturer and the operator of the machine relevant to the particular application
- Observation of the latest versions of the relevant national and international regulations, standards and guidelines (such as, the EU Machinery Directive, the regulations of the trade association and of TÜV or VDE) in the configuration, construction and operation of the machine with all its installed components
- Installation of suitable safety devices for limiting the pressure at the hydraulic ports  
⇒ [Chap. "2.5 Pressure limitation", page 16](#)
- Compliance with the preconditions for satisfying the EMC protection requirements  
⇒ [Chap. "11.5.1 Electromagnetic compatibility \(EMC\)", page 172](#)
- Use of the valves in a technically faultless and operationally safe state
- Prevention of unauthorized or improperly performed structural modifications, repairs or maintenance  
⇒ [Chap. "1.5 Structural modifications", page 7](#)  
⇒ [Chap. "10 Service", page 151](#)
- Definition and observation of the application-specific inspection and maintenance instructions
- Adherence to all the technical data relating to the storage, transportation, installation, removal, connection, start-up, configuration, operation, cleaning, maintenance or elimination of any faults, in particular the ambient conditions and the data pertaining to the hydraulic fluid used  
⇒ [Chap. "11 Technical Data", page 164](#)
- Proper storage, transportation, installation, removal, connection, start-up, configuration, operation, cleaning, maintenance, elimination of any faults or disposal
- Use of suitable and faultless accessories and of suitable and faultless spare parts  
⇒ [Chap. "12 Accessories and spare parts", page 173](#)
- Handy and accessible storage of this user manual and of the product-related hardware and software documentation relevant to the particular application  
⇒ [Chap. "1.1.3 Storage location", page 2](#)

**Responsibility of the manufacturer and the operator of the machine**

## 1.8 Warranty and liability

Our General Terms and Conditions of Sale and Payment always apply. These are made available to the buyer at the latest on conclusion of the contract.

Among other things, warranty and liability claims for personal injury and damage to property are excluded if they are caused by one or more of the following:

- Work with and on the valves carried out by or the valves handled by non-qualified personnel  
⇒ [Chap. "1.4 Selection and qualification of personnel", page 7](#)
- Non-intended operation  
⇒ [Chap. "1.3 Intended operation", page 5](#)
- Handling not in accordance with safety requirements  
⇒ [Chap. "2.1 Handling in accordance with safety requirements", page 14](#)
- Omission of the occupational safety and health measures required for the particular application  
⇒ [Chap. "2.2 Occupational safety and health", page 15](#)
- Failure to observe this user manual or the product-related hardware and software documentation relevant to the particular application
- Failure to observe the safety standards of the manufacturer and the operator of the machine relevant to the particular application
- Observation of the latest versions of the relevant national and international regulations, standards and guidelines (such as, for example, the EU Machinery Directive, the regulations of the trade association and of TÜV or VDE) in the configuration, construction and operation of the machine with all its installed components
- Omission of suitable safety devices for limiting the pressure at the hydraulic ports  
⇒ [Chap. "2.5 Pressure limitation", page 16](#)
- Failure to comply with the preconditions for satisfying the EMC protection requirements  
⇒ [Chap. "11.5.1 Electromagnetic compatibility \(EMC\)", page 172](#)
- Use of the valves in a state that is not technically faultless or not operationally safe
- Unauthorized or improperly performed structural modifications, repairs or maintenance  
⇒ [Chap. "1.5 Structural modifications", page 7](#)  
⇒ [Chap. "10 Service", page 151](#)
- Failure to adhere to the inspection and maintenance instructions of the manufacturer and the operator of machine
- Failure to adhere to all the technical data relating to the storage, transportation, installation, removal, connection, start-up, configuration, operation, cleaning, maintenance or elimination of any faults, in particular the ambient conditions and the data pertaining to the hydraulic fluid used  
⇒ [Chap. "11 Technical Data", page 164](#)
- Improper storage, transportation, installation, removal, connection, start-up, configuration, operation, cleaning, maintenance, elimination of any faults or disposal
- Use of unsuitable or defective accessories or of unsuitable or defective spare parts  
⇒ [Chap. "12 Accessories and spare parts", page 173](#)
- Catastrophes caused by foreign objects or force majeure

### Exclusion of warranty and liability

## 1.9 Declaration of conformity

A declaration of conformity in accordance with the ATEX guideline for the control valves of the type series D637K/D639K has been created and is depicted in this user manual.

### Declaration of conformity

MOOG GmbH  
Hanns-Klemm-Str. 28  
71034 Böblingen

**MOOG**

Division Industry

#### Declaration of conformity

as defined by directive 94/9/EC (ATEX), Annex X

Herewith we declare that the

**Series of Servovalves**  
**D636Kxxxx, D637Kxxxx, D638Kxxxx, D639Kxxxx**

(detailed model & serial number is referenced on the delivery note)

are in conformance with the provisions of the directive 94/9/EC (ATEX).

The admission of the series is registered under **BVS 11 ATEX E 121 X**  
by DEKRA EXAM GmbH, Dinnendahlstrasse 9, 44809 Bochum, Germany  
The monitoring body of the QM system is **TÜV Süd (0123)**

Applied harmonized standards in particular:

- EN 60079-0:2009 Electrical apparatus for potentially explosive atmospheres - General requirements.
- EN 60079-1:2007 Electrical apparatus for potentially explosive atmospheres - Flameproof enclosures "d".
- EN 60079-7:2007 Electrical apparatus for potentially explosive atmospheres - Increased safety "e".

Moog GmbH  
Postfach 1670, D-71006 Böblingen  
Phone.: 07031 622-0  
Fax: 07031 622-100

  
Gunter Kilgus  
General Manager

  
Richard Kohse  
Quality Manager  
Representative for ATEX directive 94/9/EC

Böblingen, 29.08.2011

## 1.10 Registered marks and trademarks

Moog and Moog Global Support® are registered trademarks of Moog Inc. and its subsidiaries.

Microsoft® and Windows® are either registered trademarks or trademarks of the Microsoft® Corporation in the USA and/or other countries.

### Registered marks and trademarks



All the product and company names mentioned in this user manual are possibly proprietary names or trademarks of the respective manufacturers. The use of these names by third parties for their own purposes may infringe the rights of the manufacturers. The absence of the symbols ® or ™ does not indicate that the name is free from trademark protection.



## 2 Safety

### 2.1 Handling in accordance with safety requirements



It is the responsibility of the manufacturer and the operator of the machine to ensure that the valves are handled in accordance with safety requirements.

**Handling in accordance with safety requirements**

#### CAUTION



#### **Danger of personal injury and damage to property due to unexpected operation!**

As in any electronic control system, the failure of certain components in valves as well might lead to an uncontrolled and/or unpredictable operational sequence.

- ▶ If automatic control technology is to be used, the user should, in addition to all the potentially available standards or guidelines on safety-engineering installations, consult the manufacturers of the components used in great depth.

In order to ensure that the valves are handled in accordance with safety requirements and operated without faults, it is essential to observe the following:

- All the safety instructions in the user manual
- All the safety instructions in the product-related hardware and software documentation relevant to the particular application
- All the safety instructions in the safety standards of the manufacturer and the operator of the machine relevant to the particular application
- All the relevant national and international safety and accident prevention regulations, standards and guidelines, such as for example the safety regulations of the trade association, of TÜV or VDE, and the ATEX Directive 94/9/EC and ATEX Directive 1999/92/EC, in particular the following standards pertaining to the safety of machinery:
  - EN ISO 12100
  - EN 563
  - EN 982
  - EN 60204
  - EN 60079-0
  - EN 60079-1
  - EN 60079-7

Observing the safety instructions and the safety and accident prevention regulations, standards and guidelines will help to prevent accidents, malfunctions and damage to property!

## 2.2 Occupational safety and health

### DANGER



#### Risk of poisoning and injury!

Contact with hydraulic fluids can damage your health (e.g. eye injuries, skin and tissue damage, poisoning in case of inhaling).

- ▶ Wear protective gloves and safety glasses.
- ▶ If nevertheless hydraulic fluid gets into your eyes or on your skin, consult a doctor immediately.
- ▶ When handling hydraulic fluids, observe the safety provisions applicable to the hydraulic fluid used.

**Occupational safety and health measures and equipment**

### WARNING



#### Danger of injury due to falling objects!

Falling objects, such as valves, tools, or accessories can cause injury.

- ▶ Wear appropriate safety clothing, e.g. safety shoes.

### WARNING



#### Danger of burning!

Valves and hydraulic port lines can become very hot during operation. Fingers and hands can suffer severe burn injuries when touching the valve or the connector cable.

- ▶ Allow the valve and the connector cable to cool off before contact.
- ▶ Wear appropriate safety clothing, e.g. safety gloves.

### WARNING



#### Damage to hearing!

Depending on the application, significant levels of noise may be generated when the valves are operated.

- ▶ Always protect yourself with hearing protection when working on the valves.

## 2.3 General safety instructions

### CAUTION

**Risk of damage!**

In order to prevent damage to the valves or to the machine, heed the following points:

- ▶ Values specified in the technical data must be adhered to.
- ▶ Values specified on the nameplate must be adhered to.
- ▶ ⇒ [Chap. "11 Technical Data", page 164](#)

General safety instructions



This user manual and the product-related hardware and software documentation relevant to the particular application must be inserted in the machine's operating instructions.

## 2.4 ESD

### CAUTION

**Risk of damage!**

Electrical discharges can damage internal device components.

- ▶ Protect the valve, accessories and spare parts against static charging. In particular, avoid touching the connector contacts.

ESD

## 2.5 Pressure limitation

### WARNING

**Danger of personal injury and damage to property!**

The operation of the valves at pressure that is too high on the hydraulic connections can cause injuries and damage to the machine.

- ▶ Pressure-limiting valves or other comparable safety devices, for example, must be installed to limit the pressure at all the hydraulic ports to the specified maximum operating pressure. Maximum operating pressure:  
⇒ [Chap. "11 Technical Data", page 164](#)

Safety devices for pressure limitation

## 3 Product Description

### 3.1 Function and mode of operation

The valves of the D637K/D639K type series are direct operated servo valves or proportional valves (DDV: **D**irect **D**rive **V**alve). The valves are throttle valves for 2-, 3-, 4- or even 2x2-way applications.

#### Function and mode of operation

The valves are suitable for electrohydraulic position, speed, pressure and force control even for high dynamic requirements. They control flow and/or control pressure.

The valves of the D637K type series can be used for flow control.

The valves of the D639K type series can be used for pressure and pressure limitation control and/or flow control.

The control electronics and a pressure transducer (only for D639K) are integrated in the valve.

The valve electronics with a PWM driver end stage and a 24 V direct current supply are integrated into the valve. The digital on-board electronics are installed in the electronic housing in vibration-decoupled design so that they are not sensitive to shock and vibration.

#### 3.1.1 Operational modes

Depending on the model, one of the operational modes below is preset in the valve.

Selection between the operational modes is only possible in the D639K type series valves with pQ-control and can be configured via the integrated service or field bus interface.

Operational mode	Series		
	D637K Q	D639K p      pQ	
Flow control (Q-control) ⇒ Chap. "3.3.1.1 Flow control (Q-control)", page 32	• <sup>1</sup>		•
Pressure control (p-control) ⇒ Chap. "3.3.1.2 Pressure control (p-control)", page 32		• <sup>1</sup>	•
Flow and pressure control (pQ-control) ⇒ Chap. "3.3.1.3 Flow and pressure control (pQ-control)", page 34			• <sup>1</sup>

#### Operational modes: Q, p, pQ function

Tab. 3: Operational modes of the valves

<sup>1</sup> Operational mode preset on delivery

### 3.1.2 Representative depiction of the valve

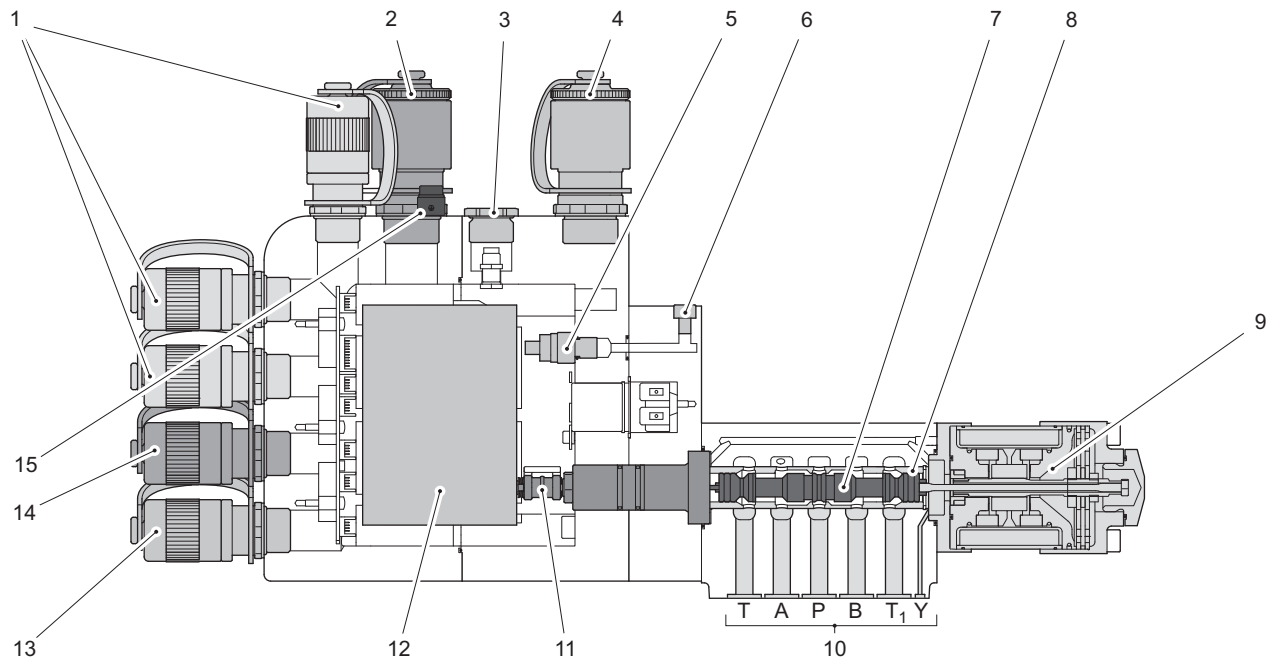

Item	Designation	Additional information
1	Analog input connectors X5...X7	The analog input connectors X5...X7 are optionally available.
2	Connector X2 for digital signal interface	The X2 connector is optionally available.
3	Service connector X10	The X10 service connector is only present for valves without CAN bus interface. By default, the X10 service connector is not approved for use in areas subject to explosion, however on request the valve can be equipped instead of the service connector with a CAN bus interface that can be used in hazardous area. Tightening torque: tighten the screw plug of the service connector with tightening torque 9.5 Nm / 7 lbf ft! ⇒ Chap. "7.10 Service connector X10", page 93 ⇒ Chap. "8.3.2 Configuration via the service interface", page 139
4	Connector X1	⇒ Chap. "7.4 Connector X1", page 76
5	Pressure transducer (LVDT)	The pressure transducer is only provided on D639K type series valves. ⇒ Chap. "3.3.1.2 Pressure control (p-control)", page 32
6	Venting screw	The venting screw is only present for valves of the D639K type series. ⇒ Chap. "8.5.1 Venting", page 142
7	Spool	
8	Bushing	Not required for valves D637K-P/D639K-P
9	Permanent magnet- linear force motor	⇒ Chap. "3.1.3 Permanent magnet linear force motor", page 19
10	Ports	⇒ Chap. "6.2.2 Mounting pattern of mounting surface", page 64
11	Position transducer (LVDT)	⇒ Chap. "3.3.1.1 Flow control (Q-control)", page 32
12	Digital valve electronics	⇒ Chap. "3.1.4 Valve electronics and valve software", page 19
13	Fieldbus-X4 connector	The field bus connectors X3 and X4 are only provided on valves with field bus interfaces. ⇒ Chap. "3.1.5.2 Field bus connectors X3 and X4", page 22 ⇒ Chap. "8.3.1 Configuration via the field bus interface", page 137
14	Fieldbus-X3 connector	
15	Ground terminal	⇒ Chap. "7.12 Protective grounding and electrical shielding"

Fig. 1: Representative depiction of a direct drive servo valve

### 3.1.3 Permanent magnet linear force motor

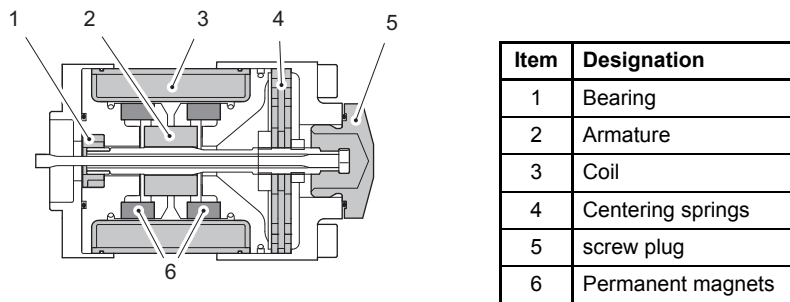

**Representative depiction of a permanent magnet linear force motor**

Fig. 2: Representative depiction of a permanent magnet linear force motor

A permanent magnet linear force motor (fig. 2 or item 9 in fig. 1) is used to drive the valve spool (item 7 in fig. 1).

In contrast to proportional-solenoid drives, the permanent magnet linear force motor can move the spool from the spring-set position in both working directions. This results in high actuating power for the spool while simultaneously providing very good static and dynamic properties.

The permanent magnet linear force motor is a differential motor excited by permanent magnets. Some of the magnetic force is already provided by the permanent magnets. The linear force motor's power demand is thus significantly lower than is the case with comparable proportional-magnet drives.

The linear force motor (item 6 fig. 2 or item 9 in fig. 1) bidirectionally drives the valve spool (item 7 in fig. 1) stiffly against the centering springs (item 4 in fig. 2). The high forces provided by this motor allow for precise spool movement even when flow and frictional forces are present. The position of the spool is then directly proportional to the coil current in the linear force motor. When no coil current is present the spool is forced to a position determined only by the centering springs. This de-energized position is configurable and can be set at the factory.

**Permanent magnet linear force motor**

### 3.1.4 Valve electronics and valve software

The digital drive and control electronics are integrated in the valve.

These valve electronics contain a microprocessor system that executes all the important functions via the valve software it contains. The digital electronics enable valve control that is both precise and repeatable across the full working range regardless of temperature.

The valve electronics can assume device- and drive-specific functions, such as command signal ramps or dead band compensation.

This can relieve the strain on external machine control and if necessary field bus communication.

**Integrated digital valve electronics and valve software**

⇒ Chap. "3.5 Valve software", page 49

### 3.1.4.1 Valve status

#### CAUTION



#### Danger of personal injury and damage to property!

The 'NOT READY' valve status is caused only by a serious, non-rectifiable fault.

- ▶ If the 'NOT READY' valve status occurs, the valve must be sent to MOOG GmbH or one of our authorized MOOG service centers for inspection.

The valve's device status is referred to as the valve status.

The valve status can be set or interrogated via the service or field bus interface in the valve software. Setting and interrogation can be performed for example with the Moog Valve and Pump Configuration Software.

⇒ [Chap. "3.6 Moog Valve and Pump Configuration Software", page 50](#)

#### Valve status

Valve status	Explanation
'ACTIVE'	The valve is ready for operation and is in closed-loop control operation.
'HOLD'	The valve is ready for operation and is in the electrical fail-safe state on account of a control command. The electrical fail-safe spool position is a closed loop parameterized setting. ⇒ <a href="#">Chap. "3.2.2 Electrical fail-safe function", page 26</a>
'FAULT HOLD'	The valve is ready for operation and is in the electrical fail-safe state on account of a fault reaction. The electrical fail-safe spool position is a closed loop parameterized setting. ⇒ <a href="#">Chap. "3.2.2 Electrical fail-safe function", page 26</a>
'DISABLED'	The valve electronics are ready for operation and the valve is in the mechanical fail-safe state on account of a control command. ⇒ <a href="#">Chap. "3.2.1.2 Mechanical fail-safe state", page 25</a> Internal parameters can be set and interrogated. The current to the permanent magnet linear force motor is switched off.
'FAULT DISABLED'	The valve electronics are ready for operation and the valve is in the mechanical fail-safe state on account of an error reaction. Internal parameters can be set and interrogated. ⇒ <a href="#">Chap. "3.2.1.2 Mechanical fail-safe state", page 25</a> The current to the permanent magnet linear force motor is switched off.
'INIT'	The valve is switched off, is in the mechanical fail-safe state and can be configured via the service or field bus interface. ⇒ <a href="#">Chap. "3.2.1.2 Mechanical fail-safe state", page 25</a>
'NOT READY'	The valve is not ready for operation and is in the mechanical fail-safe state on account of a serious non-rectifiable fault. ⇒ <a href="#">Chap. "3.2.1.2 Mechanical fail-safe state", page 25</a>

Tab. 4: Valve status

Fail-safe states and fail-safe events:

⇒ [Chap. "3.2.1 Mechanical fail-safe function", page 25](#)

⇒ [Chap. "3.2.2 Electrical fail-safe function", page 26](#)

⇒ [Chap. "3.2.3 Fail-safe events", page 27](#)

### 3.1.5 Signal interfaces

The valves have a connector, X1, with model-dependent analog and digital inputs/outputs. The connectors are an explosion-proof model.

⇒ Chap. "3.1.5.1 Connector X1", page 22

Pin assignment of the connector X1:

⇒ Chap. "7.4.1 Pin assignment of connector X1", page 76

#### WARNING



#### Danger of explosion!

To guarantee safe operation in hazardous area:

- ▶ For mounting and removal of the plug connectors as well as operation of the valve, the notes and instructions in the "Explosion-proof connectors eXLink, CEAG" operating instructions must absolutely be adhered to.

Depending on the model, the valves can also have an isolated field bus interface (connectors X3 and X4) and/or a service interface (service connector X10).

⇒ Chap. "3.1.5.2 Field bus connectors X3 and X4", page 22

⇒ Chap. "3.1.5.3 Service connector X10", page 23



For the standard model of the valve, the service interface is not suitable for use in hazardous area. On request, the service interface is available in an explosion-proof model.

	Interface		
	Connector X1	Field bus connectors X3 and X4	Service connector X10
Valves without field bus interface	•	-	• <sup>1</sup>
Valves with CAN bus interface	•	• <sup>1</sup>	
Valves with Profibus interface	•	•	• <sup>1</sup>
Valves with EtherCAT interface	•	•	• <sup>1</sup>

Tab. 5: Existing interfaces

<sup>1</sup> The valves can be started up and configured via the CAN bus or service interface with the Moog Valve and Pump Configuration Software.

⇒ Chap. "8.3.1.2 Configuration with the Moog Valve and Pump Configuration Software", page 138



It is necessary when ordering the valve to establish whether a field bus interface is to be integrated and if necessary one of the above-mentioned field bus interfaces is to be selected.

#### Interfaces for activation signals



### 3.1.5.1 Connector X1

Valves without field bus interfaces must be commanded with an analog signal via connector X1.

Valves with field bus interfaces can be commanded with an analog signal via connector X1 or with a digital signal via the field bus interface (connectors X3 and X4).

⇒ Chap. "3.4 Control", page 39

Different signal types for analog command inputs for flow control can, depending on the model, be selected in the valve.

⇒ Chap. "3.4.1 Signal types for analog command inputs", page 40

The valves have an analog actual value output:

⇒ Chap. "3.4.2 Analog actual value outputs 4–20 mA", page 48

The valves have a digital enable input:

⇒ Chap. "3.4.3 Digital enable input", page 48

Pin assignment of connector X1:

⇒ Chap. "7.4.1 Pin assignment of connector X1", page 76

**Valve Command**

**Analog command inputs**

**Analog actual value output**

**Enable input**

### 3.1.5.2 Field bus connectors X3 and X4

Valves with CAN bus interfaces can be started up and configured via the CAN bus interface (field bus connector X3) with the Moog Valve and Pump Configuration Software.

⇒ Chap. "8.3.1 Configuration via the field bus interface", page 137

To reduce the amount of wiring, the field bus interface is provided with two connectors on the valve. The valves can thus be directly looped into the field bus, i.e. without the use of external T-pieces.



The start-up, activation, monitoring, and configuration of the valves via the field bus interface (connectors X3 and X4) with the Moog Valve and Pump Configuration Software is only possible with CAN!

Valves with field bus interfaces are started up, activated, monitored and configured via the field bus interface (connectors X3 and X4).

⇒ Chap. "8.3.1.2 Configuration with the Moog Valve and Pump Configuration Software", page 138

Plug assignment of the field bus connectors X3 and X4:

⇒ Chap. "7.8 Field bus connectors X3 and X4", page 84

### 3.1.5.3 Service connector X10

Valves without CAN bus interfaces can be started up and configured via the service interface (service connector-X10) with the Moog Valve and Pump Configuration Software.

⇒ Chap. "8.3.2 Configuration via the service interface", page 139

#### WARNING



##### **Danger of explosion!**

To guarantee safe operation in hazardous area.

- ▶ In the standard model with a screw plug, the service connector X10 is not permitted for use in hazardous area.
- ▶ When mounting the screw plug of the service connector X10, it must be observed that the gasket and the thread of the screw plug as well as the thread in the electronic housing of the valve are not damaged.
- ▶ In case of damage to the screw plug for the service connector or the threads in the electronic housing, the valve must not be operated in an hazardous area.
- ▶ Tightening torque for screw plug:  
⇒ Chap. "3.1.2 Representative depiction of the valve", page 18



For the standard model of the valve, the service interface is not suitable for use in hazardous area. On request, the service interface is available in an explosion-proof model.

## 3.2 Safety function/fail-safe

### CAUTION



#### Risk of injury!

In order to prevent injuries and other damage to health during safety-critical operation, please observe the following recommendations.

- ▶ ⇒ Chap. "2.1 Handling in accordance with safety requirements", page 14

### CAUTION



#### Risk of injury!

In order to prevent injuries and other damage to health during the design, building, and operation of the machine with all installed components, please heed the following instructions.

- ▶ The manufacturer and operator of the machine are responsible for making sure that for safety-critical use, relevant safety standards in the latest version, which serve to avoid damage, are heeded.
- ▶ It is vital among other things to ensure that both the individual components and the complete machine can be rendered in a safe state.

The valve fail-safe functions increase the safety of the user if, for example, the valve supply voltage fails.

There are two different fail-safe functions: mechanical and electrical.

⇒ Chap. "3.2.1 Mechanical fail-safe function", page 25

⇒ Chap. "3.2.2 Electrical fail-safe function", page 26

The valve can be rendered in the fail-safe state by different events.

⇒ Chap. "3.2.3 Fail-safe events", page 27

The mechanical valve fail-safe state is denoted by the fact that the spool is in a defined spring-determined position.

⇒ Chap. "3.2.1.2 Mechanical fail-safe state", page 25

The electrical valve fail-safe state is denoted by the fact that the valve is in the 'HOLD' or 'FAULT HOLD' valve status and a preset command signal is corrected by suitable positioning of the spool.

It is essential to ensure at the machine end that these fail-safe states result in a safe state in the machine.

The valve must be restarted after it has adopted the fail-safe state.

⇒ Chap. "3.2.4 Restarting the valve", page 30

#### Fail-safe functions

#### Mechanical fail-safe state

#### Electrical fail-safe state

### 3.2.1 Mechanical fail-safe function

The following fail-safe functions are available:

- Fail-safe function F
- Fail-safe function D
- Fail-safe function M

#### Mechanical fail-safe functions



The fail-safe function must be specified when the valve is ordered. To see which fail-safe function is integrated into the valve, see the 6th place in the type designation.

⇒ Chap. "3.2.1.3 Fail-safe identification", page 25

#### 3.2.1.1 Valves with fail-safe function F, D or M

In the case of the mechanical fail-safe functions F, D and M, the mechanical setting of the linear force motor or corresponding centering springs at the factory establishes which position the spool assumes in the mechanical fail-safe state.

Position of spool: ⇒ Tab. 6, page 25

#### Fail-safe functions F, D and M

#### 3.2.1.2 Mechanical fail-safe state

The valve is in the mechanical fail-safe state when the spool is in a defined spring-determined position.

Fail-safe function	Position of spool
F	Defined position of the spool: approx. 10 % valve opening: P→B and A→T
D	Defined position of the spool: approx. 10 % valve opening: P→B and A→T
M	Defined overlapped center position of spool The mechanical fail-safe function M gives rise in conjunction with spools that have an overlap greater than $\pm 10\%$ , i.e. in valves with bushing-spool identification D, to the defined overlapped center position. In the case of a smaller overlap, i.e. in valves with a different bushing-spool identification, a defined overlapped center position is not possible. ⇒ Chap. "3.2.1.4 bushing-spool identification", page 26

#### Position of the spool in the mechanical fail-safe state

Tab. 6: Spool

#### 3.2.1.3 Fail-safe identification

The fail-safe identification, i.e. the 6th position in the valve type designation, indicates which mechanical fail-safe function is integrated in the valve.

Type designation: ⇒ Chap. "3.7 Nameplate", page 50

#### Fail-safe identification

Type designation:

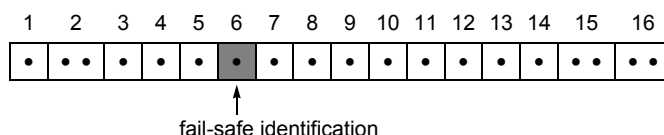

Ident.	Fail-safe function	Additional information
F	Valves with fail-safe function F	⇒ Tab. 6, page 25 ⇒ Chap. "3.2.1.1 Valves with fail-safe function F, D or M", page 25
D	Valves with fail-safe function D	
M	Valves with fail-safe function M	
X	Valves with special fail-safe function	

### 3.2.1.4 bushing-spool identification

The bushing-spool identification, i.e. the 4th position in the valve type designation, indicates which bushing-spool version is integrated in the valve.

Type designation: ⇒ Chap. "3.7 Nameplate", page 50

Type designation:

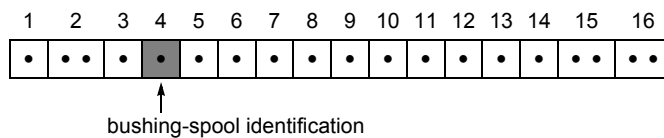

Ident.	Valve configuration	Bushing-spool version
O	4-way	Linear characteristic curve, zero lap
A	4-way	Linear characteristic curve, ±1.5 % to ±3 % positive overlap
D	4-way	Linear characteristic curve, ±10 % positive overlap
B	3-way	Valve opening: P→A and A→T (only for D639K)
Z	2x2-way	Valve opening: P→A and B→T (connect P with B and A with T externally), with port Y only
X		Special spool, on request

### Bushing-spool identification

### 3.2.2 Electrical fail-safe function

After adopting the 'HOLD' or 'FAULT HOLD' valve status, the valve is in the electrical fail-safe state and a preset command signal is corrected by suitable positioning of the spool.

Depending on the operational mode set, the command signal is a flow control and/or pressure control command signal.

The command signal can be set or interrogated via the service or field bus interface in the valve software. Setting and interrogation can be performed for example with the Moog Valve and Pump Configuration Software.

Command signals that may be applied from an external source via the field bus interface or the analog inputs are ignored in the 'HOLD' and 'FAULT HOLD' valve states.

### Electrical fail-safe function and electrical fail-safe state

### 3.2.3 Fail-safe events

#### CAUTION



#### Danger of personal injury and damage to property!

The 'NOT READY' valve status is caused only by a serious, non-rectifiable fault.

- ▶ If the 'NOT READY' valve status occurs, the valve must be sent to MOOG GmbH or one of our authorized MOOG service centers for inspection.

The valve is rendered in the fail-safe state in response to the fail-safe events set out below.

The valve must be restarted after it has adopted the fail-safe state.

⇒ Chap. "3.2.4 Restarting the valve", page 30

#### Fail-safe events

Fail-safe event	Fail-safe state		Cause of adoption of fail-safe state		
	Mechan.	Electr.	External event	Settable fault reaction	Control command
Shutdown/failure of the supply voltage	•		•		
Signals on the enable input of the connector X1 <sup>1</sup> (not possible for p/Q function)	•	•	•		
Adoption by valve of valve status	'HOLD'				•
	'FAULT HOLD'			•	
	'DISABLED'	•			•
	'FAULT DISABLED'	•			•
	'INIT'	•			•
	'NOT READY'	•		• Serious, non-rectifiable fault	

<sup>1</sup> Whether mechanical or electrical fail-safe function should be triggered must be selected on order.

Valve status: ⇒ Chap. "3.1.4.1 Valve status", page 20

#### 3.2.3.1 Shutdown/failure of the supply voltage

#### CAUTION

#### Risk of damage!

After the supply voltage to the valve is shut down, fails or drops below 18 V, the linear force motor is no longer activated by the valve electronics.

- ▶ The cause of the fault must be determined on the machine side and if necessary, eliminated.

#### Fail-safe due to shutdown/failure of the supply voltage

The valve is rendered in the mechanical fail-safe state when the supply voltage is shut down or fails.

### 3.2.3.2 Signals at the enable input

Switching of the valve to fail-safe state can also be triggered by a corresponding signal at the enable input of connector X1. Signals lower than 6.5 V at the enable input switch the valve to fail-safe state in the mechanical or electrical fail-safe state depending on the model.

⇒ Chap. "3.4.3 Digital enable input", page 48

Pin assignment of connector X1:

⇒ Chap. "7.4.1 Pin assignment of connector X1"

**Fail-safe due to signals at the enable input**

### 3.2.3.3 Settable fault reaction

#### CAUTION



#### **Danger of personal injury and damage to property!**

The 'NOT READY' valve status is caused only by a serious, non-rectifiable fault.

- ▶ If the 'NOT READY' valve status occurs, the valve must be sent to MOOG GmbH or one of our authorized MOOG service centers for inspection.

#### **Mechanical fail-safe state due to fault reaction**

The transition of the valve into the 'FAULT DISABLED' valve status and therefore into the mechanical fail-safe state can be initiated by different event, such as the supply voltage dropping below 18 V.

It is possible to set in the valve software the event for which the valve is rendered in the 'FAULT DISABLED' valve status.

The fault reaction settings can be configured or interrogated via the service or field bus interface in the valve software. Setting and interrogation can be performed for example with the Moog Valve and Pump Configuration Software.

⇒ Chap. "3.6 Moog Valve and Pump Configuration Software", page 50

The transition of the valve into the 'NOT READY' valve status and therefore into the mechanical fail-safe state is caused by a serious, non-rectifiable fault.

**Mechanical fail-safe state due to fault reaction**

#### **Electrical fail-safe state due to fault reaction**

The transition of the valve into the 'FAULT HOLD' valve status and therefore into the electrical fail-safe state can be initiated by different events, such as e.g. a fault in the electric cable

It is possible to set in the valve software the events for which the valve is rendered in the 'FAULT HOLD' valve status.

The fault reaction settings can be configured or interrogated via the service or field bus interface in the valve software. Setting and interrogation can be performed for example with the Moog Valve and Pump Configuration Software.

⇒ Chap. "3.6 Moog Valve and Pump Configuration Software", page 50

**Electrical fail-safe state due to fault reaction**

### 3.2.3.4 Control commands

The transition of the valve of the 'HOLD', 'DISABLED' and 'INIT' valve states can be initiated by a control command.

In the valve software, the valve can be put into the valve status 'HOLD,' 'DISABLED' or 'INIT.'

The valve state can be set or interrogated via the service or field bus interface in the valve software. Setting and interrogation can be performed for example with the Moog Valve and Pump Configuration Software.

⇒ [Chap. "3.6 Moog Valve and Pump Configuration Software", page 50](#)

#### Control commands



## 3.2.4 Restarting the valve

### WARNING



#### **Danger of injury due to unexpected machine movements!**

In order to avoid injuries and other risks to health on start-up of the valve after a transition into the fail-safe state, please follow the following instructions.

- ▶ The cause of the fault must be determined on the machine side and if necessary, eliminated.
- ▶ It is also necessary to ensure that restarting the valve does not give rise to unintentional or dangerous states in the machine.

### Restarting the valve

#### **After shutdown/failure of the supply voltage:**

After the transition of the valve into a fail-safe state on account of a shutdown/failure of the supply voltage to the valve, it will be necessary to restart the valve by applying the supply voltage in accordance with the technical data. If necessary, the valve must be returned to the 'ACTIVE' valve status.

#### **After application of an enable signal lower than 6.5 V:**

After the transition of the valve into a fail-safe state on account of the application of an enable signal lower than 6.5 V, it will be necessary to restart the valve by applying an enable signal between 8.5 V and 32 V.

#### **After transition of the valve into of the 'FAULT DISABLED' or 'FAULT HOLD' valve status:**

After the transition of the valve into the fail-safe state on account of a transition into the 'FAULT DISABLED' or 'FAULT HOLD' valve status, it can be restarted as follows:

- Acknowledge the fault via the service or field bus interface and return the valve to the 'ACTIVE' valve status.
- Set the supply voltage for at least 1 second under defined conditions to zero and then restore the supply voltage in accordance with the technical data. If necessary, the valve must be returned to the 'ACTIVE' valve status.

#### **After transition of the valve into the 'HOLD', 'DISABLED' or 'INIT' valve status:**

After the transition of the valve into the fail-safe state on account of adoption of the 'HOLD', 'DISABLED' or 'INIT' valve status, it can be restarted as follows:

- Return the valve to the 'ACTIVE' valve status.
- Apply an enable signal less than 6.5 V, then apply an enable signal between 8.5 V and 32 V and return the valve to the 'ACTIVE' valve status.
- For valves without field bus interface: set the supply voltage for at least 1 second under defined conditions to zero and then restore the supply voltage in accordance with the technical data.

## 3.3 Hydraulics

### CAUTION



**Danger of personal injury and damage to property!**

In order to ensure proper operation of the valves and of the machine, heed the following:

- ▶ The correct configuration of the valve with regard to flow and pressure is required.

### 3.3.1 Operational modes

Possible operational modes of the different Series: ⇒ [Tab. 3, page 17](#)

### 3.3.1.1 Flow control (Q-control)

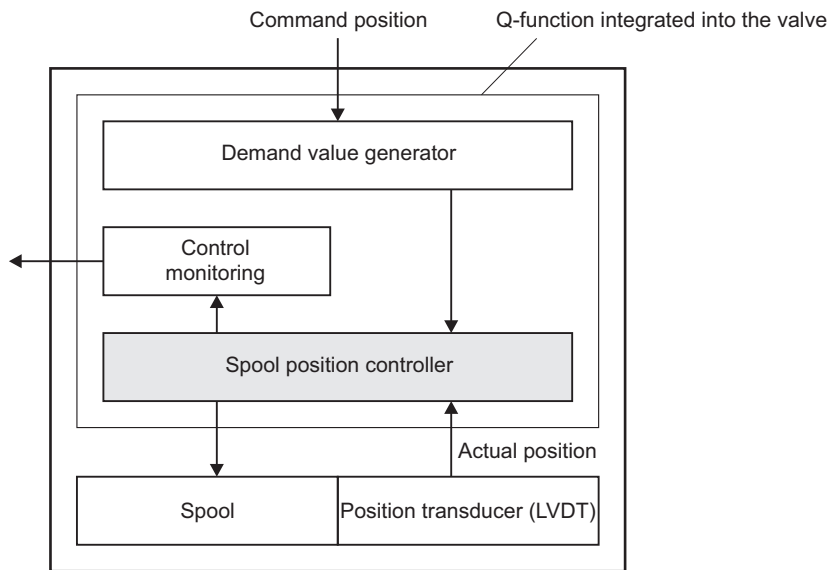

**Flow control (Q-function):**  
regulation of the position  
of the spool

Fig. 3: Flow control (Q-control) block diagram

In this operational mode the position of the spool is controlled. The predefined command signal corresponds to a particular spool position. The position of the spool is proportional to the control signal.

The command signal (command position for the spool) is transmitted to the valve electronics. The actual spool position is measured with a position transducer (LVDT) and transmitted to the valve electronics. Deviations between the predefined command position and the measured actual position of the spool are corrected. The valve electronics drive the linear force motor, which positions the spool accordingly. This process sets a specific flow.

The position command can be influenced by means of parameters in the valve software (e.g., linearization, ramping, dead band, sectionally defined amplification, correction of the zero position).

The parameters can be set or interrogated via the service or field bus interface in the valve software. Setting and interrogation can be performed for example with the Moog Valve and Pump Configuration Software.

The flow rate to be set depends not only on the position of the spool, but also on the pressure difference  $\Delta p$  at the individual control lands.

⇒ Chap. "3.5 Valve software", page 49

⇒ Chap. "4.1 Flow diagram (4-way operation)", page 51

⇒ Chap. "4.2 Flow signal characteristic curve", page 52

### 3.3.1.2 Pressure control (p-control)



Faultless valve functioning for pressure control is only guaranteed if the control loop is stable and the pressure in port T is lower than the pressure to be controlled.

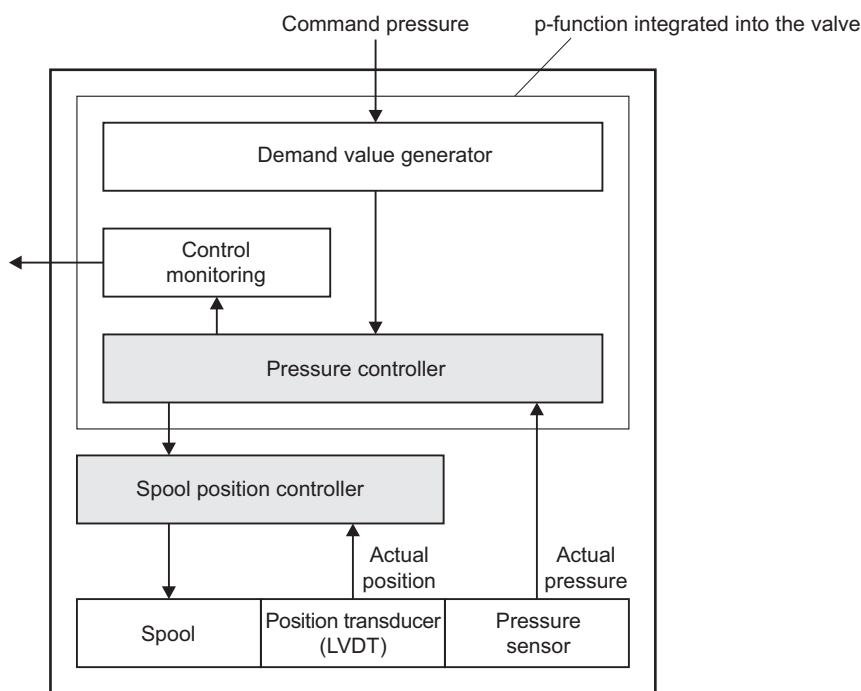

**Pressure control (p-control): controlling the pressure in the valve port A**

Fig. 4: Pressure control (p-control) block diagram

In this operational mode the pressure in port A is controlled. The predefined command signal corresponds to a particular pressure in port A.

The command signal (command pressure for port A) is transmitted to the valve electronics. The pressure in port A is measured with a pressure transducer and transmitted to the valve electronics as the actual pressure. Deviations between the predefined command pressure and the pressure measured in port A are corrected. The valve electronics drive the linear force motor, which positions the spool accordingly. This process sets a specific flow, which results in a pressure change in port A. The controlled pressure follows the command signal proportionally.

The pressure command can be influenced by means of parameters in the valve software (e.g., ramps, scaling, limitation).

The pressure controller is designed as an extended PID controller. The parameters of the PID controller and of the integrated pressure transducer can be set or interrogated via the service or field bus interface in the valve software. Setting and interrogation can be performed for example with the Moog Valve and Pump Configuration Software.

⇒ Chap. "3.3.5 Notes on the pressure controller control response (D639K)", page 38

⇒ Chap. "3.5 Valve software", page 49

⇒ Chap. "3.6 Moog Valve and Pump Configuration Software", page 50



High pressure peaks in the hydraulic system can result in a drift of the valve's internal pressure transducer.

To monitor any possible drift of the valve's pressure transducer, we recommend that the pressure transducer be checked 3, 6 and 12 months after the valve is started up and thereafter at intervals of 6 months. This can be conducted for example using comparison measurements with a calibrated pressure gauge. If necessary, the internal pressure transducer must be recalibrated.

The pressure transducer can be influenced by means of parameters in the valve software. The parameters can be set or interrogated via the service or field bus interface in the valve software. Setting and query can, for example, take place with the Moog Valve and Pump Configuration Software.

### Monitoring the pressure transducer drift

### 3.3.1.3 Flow and pressure control (pQ-control)

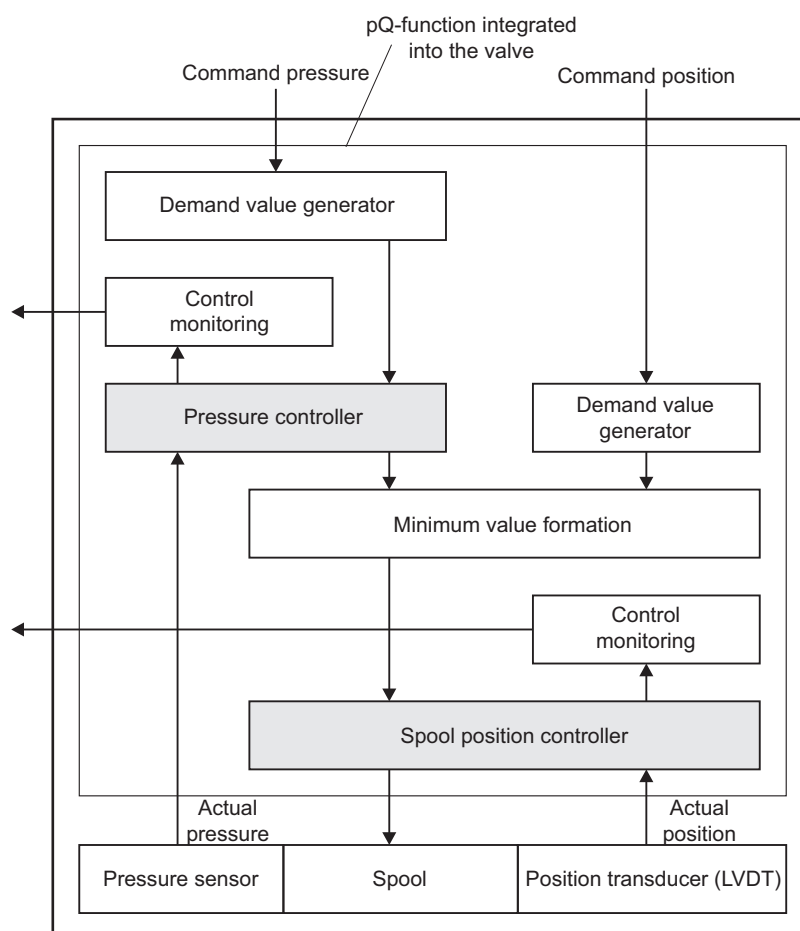

### Flow and pressure control (pQ-control)

Fig. 5: Flow and pressure control (pQ-control) block diagram

This operational mode is a combination of flow and pressure control, where both command signals, i.e. the command position for the spool and the command pressure for port A, must be provided.

In pQ-control the position command calculated by the pressure controller is compared with the position command applied from an external source. The smaller of the two command signals is forwarded to the position control loop.

The following combinations are for example possible:

- Flow control with superimposed pressure limitation control
- Forced changeover from one operational mode to the other

### 3.3.2 Valve configurations and hydraulic symbols

Depending on the model, the following valve configurations are possible:

- 2-way operation  
⇒ Chap. "3.3.2.2 2-way and 2x2-way operation", page 36
- 3-way operation  
⇒ Chap. "3.3.2.1 4-way and 3-way operation", page 35
- 4-way operation  
⇒ Chap. "3.3.2.1 4-way and 3-way operation", page 35
- 2x2-way operation  
⇒ Chap. "3.3.2.2 2-way and 2x2-way operation", page 36

#### Valve configurations

#### 3.3.2.1 4-way and 3-way operation

With 4-way operation the valves can be used to control the flow in ports A and B (used as throttle valves).

#### 4-way and 3-way operation

Port A or B must be sealed in order to obtain 3-way operation.

Leakage port Y must be used if the pressure in tank port T exceeds a value of 50 bar (725 psi).

⇒ Chap. "3.3.3 Leakage port Y", page 36

The valves are available with zero lap (less than  $\pm 3\%$ ) or  $\pm 10\%$  positive overlap.

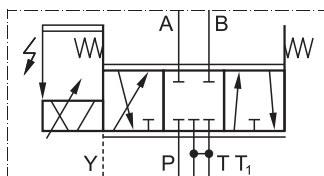

Fig. 6: 4-way operation with mechanical fail-safe function M (hydraulic symbol)

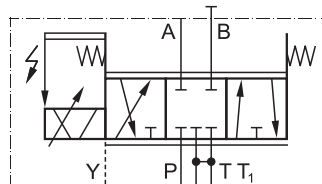

Fig. 7: 3-way operation with mechanical fail-safe function M (hydraulic symbol)

#### Hydraulic symbols: 4-way and 3-way operation

⇒ Chap. "3.2.1.1 Valves with fail-safe function F, D or M", page 25

### 3.3.2.2 2-way and 2x2-way operation

With 2-way and 2x2-way operation the valves can be used to control the flow in one direction (used as throttle valves).

#### 2-way and 2x2-way operation

With 2x2-way operation the valve can be used in 2-way applications for greater flows.

Ports P with B and A with T must externally be connected for this purpose.

The direction of flow must be observed as per fig. 9.



Leakage port Y must always be connected with 2x2-way operation.  
⇒ Chap. "3.3.3 Leakage port Y", page 36

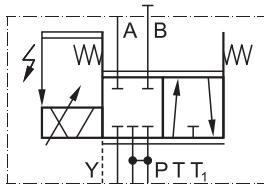

Fig. 8: 2-way operation with mechanical fail-safe function M (hydraulic symbol)

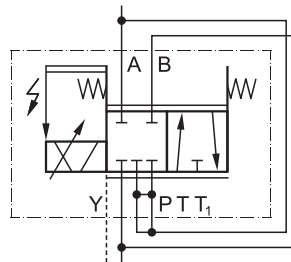

Fig. 9: 2x2-way operation with mechanical fail-safe function M (hydraulic symbol)

⇒ Chap. "3.2.1.1 Valves with fail-safe function F, D or M", page 25

### 3.3.3 Leakage port Y

Leakage port Y must be used in the following cases:

#### Leakage port Y

- when the pressure  $p_T$  in tank port T is greater than 50 bar (725 psi)
- with 2x2-way operation



The valve can be supplied either with or without leakage port Y. It is necessary when ordering the valve to establish whether leakage port Y is to be used. Whether leakage port Y is used can be ascertained from the Y identification, i.e. the 7th position in the type designation.  
⇒ Chap. "3.3.3.1 Y identification", page 37

### 3.3.3.1 Y identification

The Y identification, i.e. the 7th position in the valve type designation, indicates how leakage port Y is configured in the valve.

### Y identification

Type designation: ⇒ [Chap. "3.7 Nameplate", page 50](#)

Type designation:

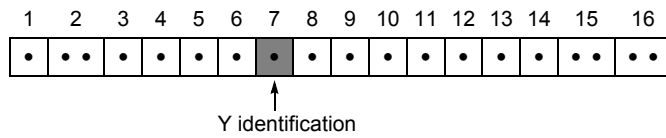

Ident.	Leakage port Y	Can be used when
0	Closed, with screw plug	Pressure in tank port $p_T \leq 50$ bar (725 psi)
3	Open, with filter element	Pressure in tank port $p_T > 50$ bar (725 psi)

### 3.3.4 Electrical and hydraulic zero positions



The hydraulic zero position of the spool is not necessarily identical to the electrical zero position.

The electrical zero position of the spool is set if the command signal input for the spool position is equal to zero.

### Electrical and hydraulic zero positions of the spool

The hydraulic zero position is the position of the spool in which the pressures, when the spool is symmetrical, are equal in the two sealed control ports.

The hydraulic zero position is model-dependent.

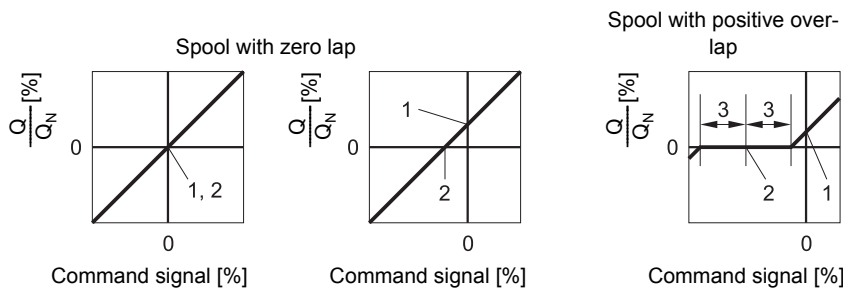

Item	Designation
1	Electrical zero position of the spool
2	Hydraulic zero position of the spool
3	Spool overlap

Fig. 10: Examples of the electrical and hydraulic zero positions of different spools in the flow signal characteristic curve



### 3.3.5 Notes on the pressure controller control response (D639K)

The controlled system is essentially influenced by:

- Rated flow  $Q_N$
- Actual pressure difference  $\Delta p$  per control land
- Load stiffness
- The fluid volume connected with port A and to be controlled

**Notes on the pressure controller control response (D639K)**

Depending on differences in machine construction (such as volume, pipework, branching, accumulators.), different pressure controller configurations may be required in pressure control.

The pressure controller configurations can be set or interrogated via the service or field bus interface in the valve software.

Setting and interrogation can be performed for example with the Moog Valve and Pump Configuration Software.

Up to 16 pressure controller configurations can be stored and activated during operation.

⇒ [Chap. "3.6 Moog Valve and Pump Configuration Software", page 50](#)

## 3.4 Control

Valves without field bus interfaces must be controlled with analog command signals via connector X1.

Valves with field bus interfaces can be controlled either with analog command signals via connector X1 or with digital signals via the field bus interface (connectors X3 and X4).

### Control of the valves

#### DANGER



#### Danger!

Danger due to electric shock.

- ▶ Only use SELV/PELV power supplies to supply the valve.

### 3.4.1 Signal types for analog command inputs

Valves without field bus interfaces must be controlled with analog command signals via connector X1.

Different signal types for analog command inputs for flow or pressure control can, depending on the model, be set in the valve.

The signal type can be set via the service or field bus interface in the valve software. Setting and interrogation can be performed for example with the Moog Valve and Pump Configuration Software.

⇒ [Chap. "3.6 Moog Valve and Pump Configuration Software", page 50](#)

#### Analog command inputs

Signal types for command inputs	Benefits
±10 V or 0–10 V	Simple measurement of the signal, e.g. with an oscilloscope
±10 mA or 0–10 mA	In contrast to the 4–20 mA signal type, less power is required with low command signals; large transmission lengths are possible
4–20 mA	Detection of fault in the electrical line and large transmission lengths are possible

#### Benefits of the different signal types for analog command inputs



It is necessary when ordering the valve to establish which signal type for the analog command inputs is to be set in the valve on delivery.

Which signal type has been set in the valve on delivery can be ascertained from the signal type identification, i.e. the 10th position in the type designation.

⇒ [Chap. "3.4.1.1 Signal type identification", page 41](#)

Which signal type is currently set can be ascertained for example with the Moog Valve and Pump Configuration Software.



All current and voltage inputs are differential, but can be connected to ground (single-ended) by means of external wiring.

Basically, activation of the command inputs with differential signals is to be preferred. If the command signal cannot be transmitted differentially, the reference point of the command input at the valve must be connected to ground (GND).

⇒ [Chap. "7.14.1 Single-ended command signals", page 110](#)

Because current inputs have a lower input resistance than voltage inputs and are therefore less prone to interference, a current signal is preferable to a voltage signal.

Pin assignment of connector X1:

⇒ [Chap. "7.4.1 Pin assignment of connector X1", page 76](#)

### 3.4.1.1 Signal type identification

The signal type identification, i.e. the 10th position in the valve type designation, indicates which signal type for the command inputs is set in the valve when it is delivered.

Type designation: ⇒ [Chap. "3.7 Nameplate", page 50](#)

**Type designation:**

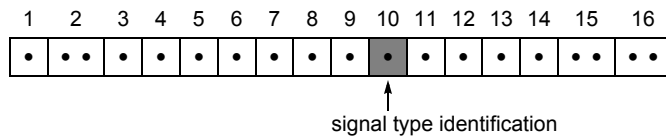

Ident.	Explanation
M	Analog command signals via floating voltage inputs: Flow control command input $\pm 10$ V and pressure control command input 0–10 V Circuit and characteristic curve: ⇒ <a href="#">Fig. 11, page 42</a> and ⇒ <a href="#">Fig. 14, page 45</a> Pin assignment of connector X1: and
X	Analog command signals via differential voltage inputs: Flow control command input $\pm 10$ mA and pressure control command input 0–10 mA Circuit and characteristic curve: ⇒ <a href="#">Fig. 12, page 43</a> and ⇒ <a href="#">Fig. 15, page 46</a> Pin assignment of connector X1: and
E	Analog command signals via differential voltage inputs: Flow control command input 4–20 mA and pressure control command input 4–20 mA Circuit and characteristic curve: ⇒ <a href="#">Fig. 13, page 44</a> and ⇒ <a href="#">Fig. 16, page 47</a> Pin assignment of connector X1: and
9	Digital command signals via field bus interface



The type designation and the signal type for analog command inputs on the nameplate indicate the valve's delivery status.

The signal type can be set via the service or field bus interface in the valve software and therefore it is possible to change the valve in such a way that it no longer conforms to this status.

Which signal type is currently set can be ascertained for example with the Moog Valve and Pump Configuration Software.

### Signal type identification

### 3.4.1.2 Flow control command inputs

#### Signal type for the command input: $\pm 10$ V

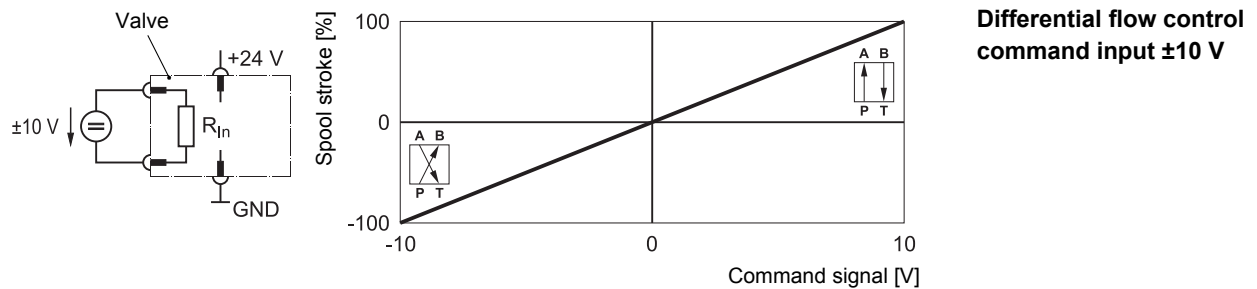

Fig. 11: Differential flow control command input  $\pm 10$  V (circuit and characteristic curve)

In the case of this signal type, the input is configured as a differential voltage input with a  $\pm 10$  V input range.

The spool stroke is proportional to the input voltage  $U_{in}$ .

$U_{in} = 10$  V      100 % spool stroke, valve opening: P→A and B→T

$U_{in} = 0$  V      Spool in electrical zero position

$U_{in} = -10$  V      100 % spool stroke, valve opening: P→B and A→T

The differential input resistance  $R_{in}$  is 20 k $\Omega$ .

The input resistance referenced to supply zero is approx. 150 k $\Omega$ .

#### CAUTION



#### Danger of personal injury and damage to property!

The potential difference of each input to GND must be between -15 V and 32 V.

- ▶ Only use SELV/PELV power supplies.
- ▶ Heed the correct dimensioning of the cables.

If there is no differential command input source available, the reference point of the command inputs must be connected to 0 V of the command input source (GND).

The operating direction of the command signal can be altered by modifying the parameters of the valve software.

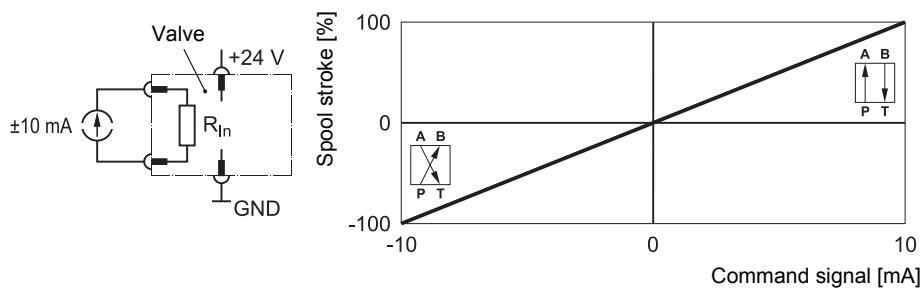
**Signal type for the command input:  $\pm 10$  mA****Differential flow control  
command input  $\pm 10$  mA**Fig. 12: Differential flow control command input  $\pm 10$  mA (circuit and characteristic curve)

In the case of this signal type, the input is configured as a differential voltage input with a  $\pm 10$  mA input range.

The input current to be measured  $I_{in}$  is directed via the two input pins to an internal shunt.

The spool stroke is proportional to the input current  $I_{in}$ .

$I_{in} = 10$  mA      100 % spool stroke, valve opening: P→A and B→T

$I_{in} = 0$  mA      Spool in electrical zero position

$I_{in} = -10$  mA      100 % spool stroke, valve opening: P→B and A→T

The differential input resistance  $R_{in}$  is 200  $\Omega$ .

The input resistance referenced to supply zero is approx. 150 k $\Omega$ .

**CAUTION****Danger of personal injury and damage to property!**

The potential difference of each input to GND must be between -15 V and 32 V.

- ▶ Only use SELV/PELV power supplies.
- ▶ Heed the correct dimensioning of the cables.

**CAUTION****Risk of valve electronic damage!**

The input current must be between -25 mA and 25 mA. Input currents outside this permissible range will destroy the input.

- ▶ Only use SELV/PELV power supplies.
- ▶ Heed the correct dimensioning of the cables.

If there is no differential command input source available, the reference point of the command inputs must be connected to 0 V of the command input source (GND).

The operating direction of the command signal can be altered by modifying the parameters of the valve software.

### Signal type for the command input: 4–20 mA

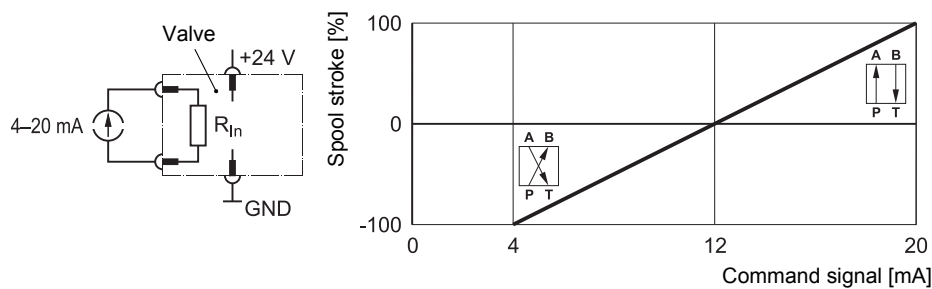

Differential flow control  
command input 4–20 mA

Fig. 13: Differential flow control command input 4–20 mA (circuit and characteristic curve)

In the case of this signal type, the input is configured as a differential voltage input with a 4–20 V input range.

The input current to be measured  $I_{in}$  is directed via the two input pins to an internal shunt.

The spool stroke is proportional to the input current  $I_{in}$ .

$I_{in} = 20 \text{ mA}$     100 % spool stroke, valve opening: P→A and B→T

$I_{in} = 12 \text{ mA}$     Spool in electrical zero position

$I_{in} = 4 \text{ mA}$     100 % spool stroke, valve opening: P→B and A→T

The differential input resistance  $R_{in}$  is 200  $\Omega$ .

The input resistance referenced to supply zero GND is approx. 150 k $\Omega$ .

#### CAUTION



##### Danger of personal injury and damage to property!

In the signal range 4–20 mA input currents < 3 mA can cause faulty reactions with digital valves.

- ▶ Examine the connection cables for defects.

#### CAUTION



##### Danger of personal injury and damage to property!

The potential difference of each input to GND must be between -15 V and 32 V.

- ▶ Only use SELV/PELV power supplies.
- ▶ Heed the correct dimensioning of the cables.

#### CAUTION

##### Risk of valve electronic damage!

The input current must be between -25 mA and 25 mA. Input currents outside this permissible range will destroy the input.

- ▶ Only use SELV/PELV power supplies.
- ▶ Heed the correct dimensioning of the cables.

If there is no differential command input source available, the reference point of the command inputs must be connected to 0 V of the command input source (GND).

The operating direction of the command signal can be altered by modifying the parameters of the valve software.

### 3.4.1.3 Pressure control command inputs

#### Signal type for the command input: 0–10 V

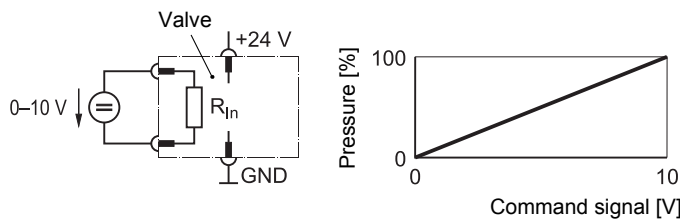

**Differential pressure control command input 0–10 V**

Fig. 14: Differential flow control command input 0–10 V (circuit and characteristic curve)

In the case of this signal type, the input is configured as a differential voltage input with a 0–10 V input range.

The pressure in control port A is proportional to the input voltage  $U_{in}$ .

$$U_{in} = 10 \text{ V} \quad 100 \% \text{ pressure in control port A}$$

$$U_{in} = 0 \text{ V} \quad 0 \% \text{ pressure in control port A}$$

The differential input resistance  $R_{in}$  is 20 k $\Omega$ .

The input resistance referenced to supply zero is approx. 150 k $\Omega$ .

#### CAUTION



#### **Danger of personal injury and damage to property!**

The potential difference of each input to GND must be between -15 V and 32 V.

- ▶ Only use SELV/PELV power supplies.
- ▶ Heed the correct dimensioning of the cables.

If there is no differential command input source available, the reference point of the command inputs must be connected to 0 V of the command input source (GND).



### Signal type for the command input: 0–10 mA

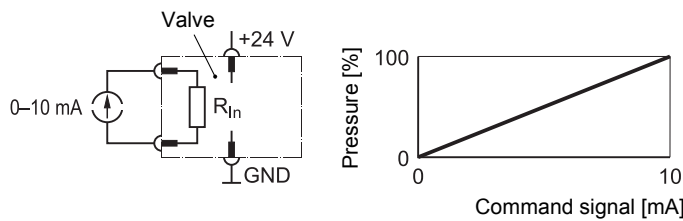

**Differential pressure  
control command  
input 0–10 mA**

Fig. 15: Differential flow control command input 0–10 mA (circuit and characteristic curve)

In the case of this signal type, the input is configured as a differential voltage input with a 0–10 mA input range.

The input current to be measured  $I_{in}$  is directed via the two input pins to an internal shunt.

The pressure in control port A is proportional to the input current  $I_{in}$ .

$$I_{in} = 10 \text{ mA} \quad 100 \% \text{ pressure in control port A}$$

$$I_{in} = 0 \text{ mA} \quad 0 \% \text{ pressure in control port A}$$

The differential input resistance  $R_{in}$  is 200  $\Omega$ .

The input resistance referenced to GND is approx. 150 k $\Omega$ .

#### CAUTION



##### **Danger of personal injury and damage to property!**

The potential difference of each input to GND must be between -15 V and 32 V.

- ▶ Only use SELV/PELV power supplies.
- ▶ Heed the correct dimensioning of the cables.

#### CAUTION

##### **Risk of valve electronic damage!**

The input current must be between -25 mA and 25 mA. Input currents outside this permissible range will destroy the input.

- ▶ Only use SELV/PELV power supplies.
- ▶ Heed the correct dimensioning of the cables.

If there is no differential command input source available, the reference point of the command inputs must be connected to 0 V of the command input source (GND).

### Signal type for the command input: 4–20 mA

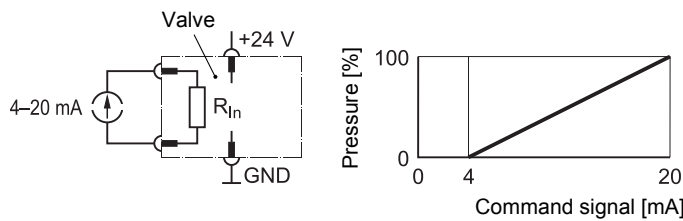

**Differential pressure  
control command  
input 4–20 mA**

Fig. 16: Differential flow control command input 4–20 mA (circuit and characteristic curve)

In the case of this signal type, the input is configured as a differential voltage input with a 4–20 V input range.

The input current to be measured  $I_{in}$  is directed via the two input pins to an internal shunt.

The pressure in control port A is proportional to the input current  $I_{in}$ .

$$I_{in} = 20 \text{ mA} \quad 100 \% \text{ pressure in control port A}$$

$$I_{in} = 4 \text{ mA} \quad 0 \% \text{ pressure in control port A}$$

The differential input resistance  $R_{in}$  is 200  $\Omega$ .

The input resistance referenced to GND is approx. 150 k $\Omega$ .

#### CAUTION



##### **Danger of personal injury and damage to property!**

In the signal range 4–20 mA input currents < 3 mA can cause faulty reactions with digital valves.

- ▶ Examine the connection cables for defects.

#### CAUTION



##### **Danger of personal injury and damage to property!**

The potential difference of each input to GND must be between -15 V and 32 V.

- ▶ Only use SELV/PELV power supplies.
- ▶ Heed the correct dimensioning of the cables.

#### CAUTION

##### **Risk of valve electronic damage!**

The input current must be between -25 mA and 25 mA. Input currents outside this permissible range will destroy the input.

- ▶ Only use SELV/PELV power supplies.
- ▶ Heed the correct dimensioning of the cables.

If there is no differential command input source available, the reference point of the command inputs must be connected to 0 V of the command input source (GND).

## 3.4.2 Analog actual value outputs 4–20 mA

Depending on the model, the valve can have different analog actual value outputs for flow and/or pressure control.

**Analog actual value outputs**

Pin assignment of connector X1:

⇒ [Chap. "7 Electrical connection", page 68](#)

Conversion of actual value output signals  $I_{out}$  4–20 mA into 2–10 V:

⇒ [Chap. "7 Electrical connection", page 68](#)

The reference point for the 4–20 mA analog actual value outputs is GND. The load impedance  $R_L$  must be in the range of 0–500  $\Omega$ .



External detection of electrical cable faults can be realized with the 4–20 mA analog actual value outputs.



The 4–20 mA actual value outputs are short-circuit protected.

### 3.4.2.1 Spool position actual value output

The output current  $I_{out}$  is proportional to the spool position.

**Spool position actual value output 4–20 mA**

$I_{out} = 20 \text{ mA}$  100 % spool stroke, valve opening: P→A and B→T

$I_{out} = 12 \text{ mA}$  Spool in electrical zero position

$I_{out} = 4 \text{ mA}$  100 % spool stroke, valve opening: P→B and A→T

### 3.4.2.2 Pressure actual value output

The output current  $I_{out}$  is proportional to the pressure in control port A.

**Pressure actual value output 4–20 mA**

$I_{out} = 20 \text{ mA}$  100 % pressure in control port A

$I_{out} = 4 \text{ mA}$  0 % pressure in control port A

## 3.4.3 Digital enable input

The valves with p and q function have a digital enable input.

**Enable input**

Switching of the valve to standby or fail-safe state can also be triggered by corresponding signals at the enable input of connector X1:

- Signals between 8.5 V and 32 V based on GND at the enable input switch the valve to ACTIVE.
- Signals lower than 6.5 V at the enable input switch the valve to its mechanical or electrical fail-safe state depending on the model.

Pin assignment of connector X1:

⇒ [Chap. "7.4.1 Pin assignment of connector X1"](#)

Fail-safe state of the valves:

⇒ [Chap. "3.2 Safety function/fail-safe", page 24](#)

The input current of the digital enable input is 2.3 mA with connection of the digital enable input to 24 V DC.

## 3.5 Valve software

By changing the configuration of the software in the valve, the functionality of the valve can be influenced.

**Valve software**

⇒ [Chap. "8.3 Configuration of the valves", page 136](#)

### CAUTION



#### **Risk of personal injuries!**

In case of malfunctions of the valve due to incorrectly-configured software, there is a danger due to uncontrolled movements of the higher-level machine and destruction in the area around the higher-level machine.

- ▶ When changing the configuration of the valve, make sure that the functionality of the valve matches that described in the operating instructions and the planned functionality.

The valve software is an integral part of the valve and cannot be altered, copied or replaced by the user.

Many of the functions made available by the valve software can be configured by the user by modifying parameters. For this purpose, the desired parameters must be transferred to the valve via the service or field bus interface. Parameters can be modified by each field bus node, for example by the machine controller.

**Configuration of the valves**



If the valve is incorporated in a field bus, the parameters can be transferred to the valve each time the system is powered up. This ensures that the valve always receives the correct configuration of the valve software.

The Moog Valve and Pump Configuration Software is available as an accessory to simplify start-up, diagnosis and configuration of the valves.

⇒ [Chap. "3.6 Moog Valve and Pump Configuration Software", page 50](#)

## 3.6 Moog Valve and Pump Configuration Software

The Moog Valve and Pump Configuration Software is a Microsoft® Windows® application enabling fast and convenient start-up, diagnosis and configuration of the valves.

The Moog Valve and Pump Configuration Software communicates with the valves via the service or CAN bus interface. A PC with a suitable interface card is required for this purposes.

The Moog Valve and Pump Configuration Software offers the following functions:

- Transfer of data between PC and valves
- Storage of the current valve settings on the PC
- Activation of the valves with graphic software control elements
- Graphic representation of status information, command signals and actual values as well as characteristic curves for the valves
- Recording and visualization of the system parameters with the integrated oscilloscope function



The Moog Valve Configuration Software is available as an accessory.  
⇒ [Chap. "12.1 Accessories", page 173](#)

### Moog Valve and Pump Configuration Software

## 3.7 Nameplate

See "Technical data":

- ⇒ [Chap. "11.1 Nameplates", page 165](#)
- ⇒ [Chap. "11.1.1 Model number", page 167](#)
- ⇒ [Chap. "11.1.2 LSS address \(Layer Setting Services\)", page 167](#)
- ⇒ [Chap. "11.1.3 Data matrix code", page 167](#)

### Nameplate

## 4 Characteristic curves

### 4.1 Flow diagram (4-way operation)

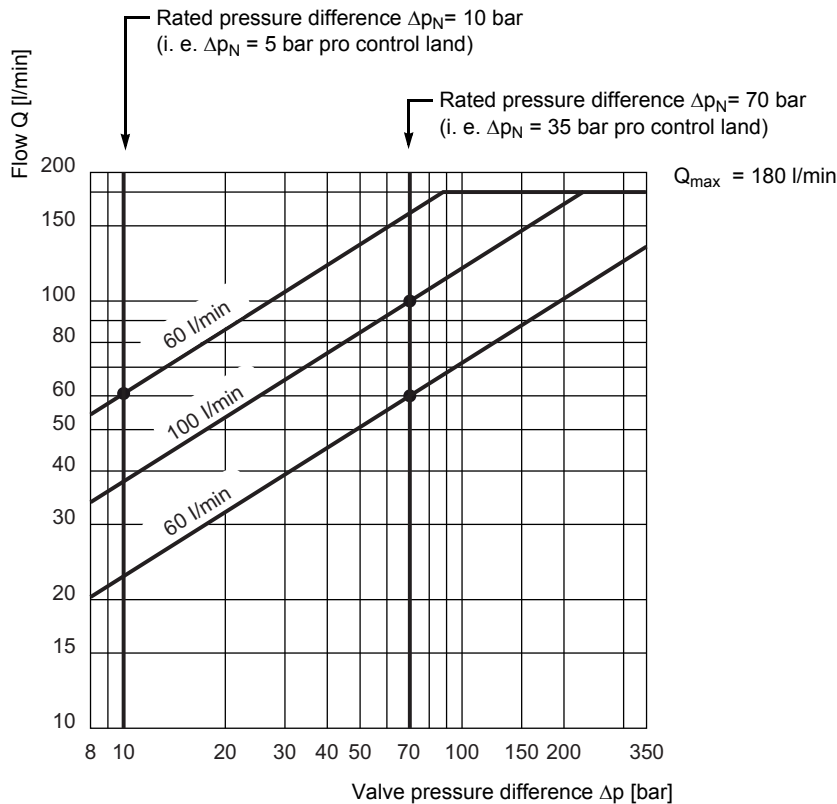

Flow diagram  
(4-way operation)

Fig. 17: Flow diagram (4-way operation)

The flow rate to be set depends not only on the position of the spool, but also on the pressure difference  $\Delta p$  at the individual control lands.

For a target value in flow control of 100 % there arises for the valves D637K-R and D639K-R with a rated pressure difference of  $\Delta p_N = 35$  bar per control land for the valves D637K-P and D639K-P  $\Delta p_N = 5$  bar per control land of the rated flow  $Q_N$ . If the pressure difference is altered, so the flow  $Q$  also changes with a constant command signal in accordance with the following formula:

Formula for calculating  
the flow Q

$$Q = Q_N \cdot \sqrt{\frac{\Delta p}{\Delta p_N}}$$

Q [l/min] : actual flow

$Q_N$  [l/min] : rated flow

$\Delta p$  : Actual pressure difference per control land  
[bar/psi]

$\Delta p_N$  : Rated pressure difference  $\Delta p_N = 35$  bar per control land  
[bar/psi]



To avoid cavitation, the flow speed of the actual flow Q, calculated in this way, at ports (A, B, P, T, etc.) must not be too great. In typical applications the maximum permissible flow speed is 30 m/s (approx. 100 ft/s).

⇒ Chap. "3.3.1.1 Flow control (Q-control)", page 32

## 4.2 Flow signal characteristic curve

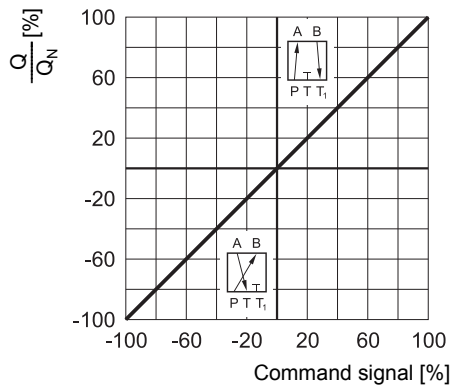

Fig. 18: Flow signal characteristic curve with equal electrical and hydraulic zero positions

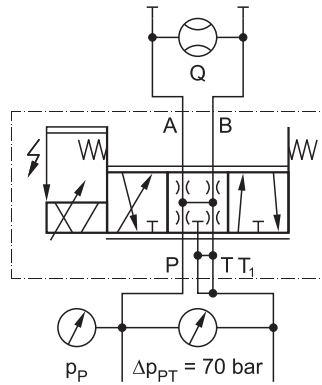

Fig. 19: Design for measuring the flow signal characteristic curve

Flow signal characteristic curve

## 4.3 Pressure signal characteristic curves<sup>1</sup>

### 4.3.1 Valves with controlled spool position

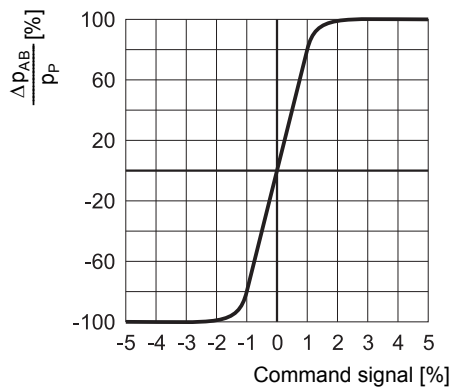

Fig. 20: Pressure signal characteristic curve of the valves with controlled spool position and zero lap

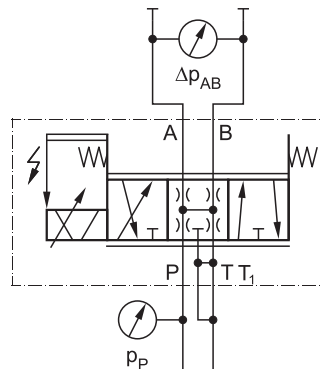

Fig. 21: Design for measuring the pressure signal characteristic curve on valves with controlled spool position

Pressure signal characteristic curve of the valves with controlled spool position and zero lap

<sup>1</sup> Typical characteristic curve  
(measured at operating pressure  $p_P = 140$  bar, viscosity of the hydraulic fluid  $\nu = 32$  mm<sup>2</sup>/s and temperature of the hydraulic fluid  $T = 40$  °C)

### 4.3.2 Pressure control valves

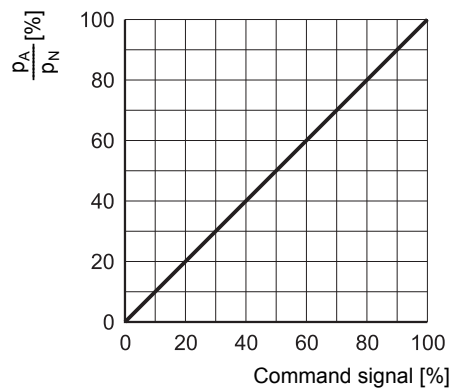

Fig. 22: Pressure characteristic curve of the pressure control valves

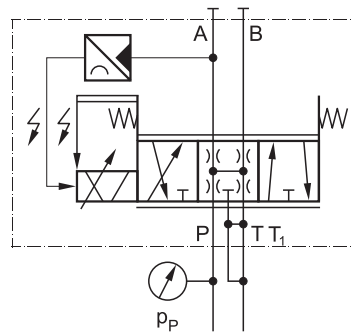
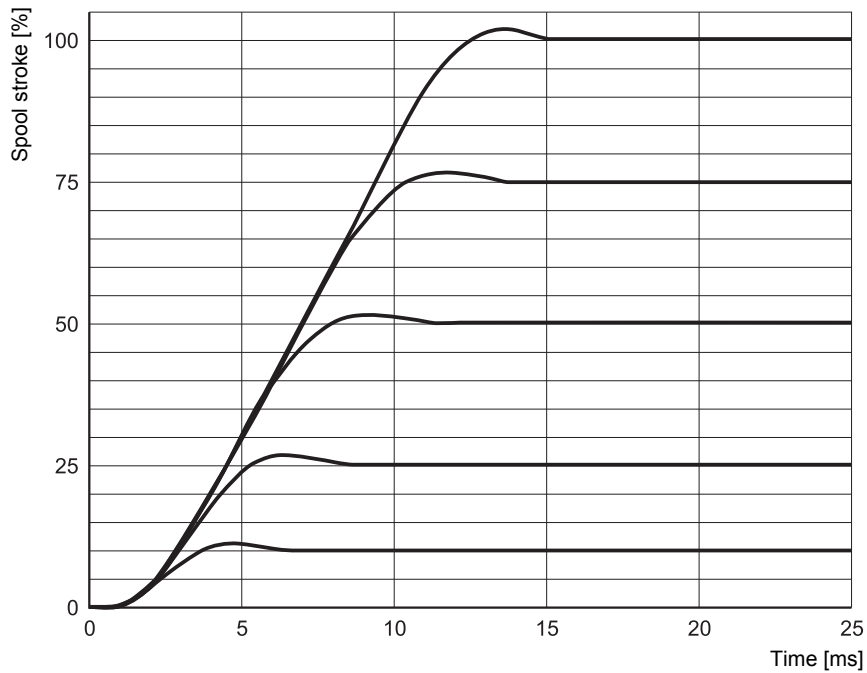

Fig. 23: Design for measuring the pressure signal characteristic curve on pressure control valves

**Pressure characteristic curve of the pressure control valves**



## 4.4 Step response and frequency response <sup>1</sup>



Step response  
of the spool stroke  
(D637K-R)

Fig. 24: Step response of the spool stroke for valves with  $Q_N = 60$  l/min (16 gpm)

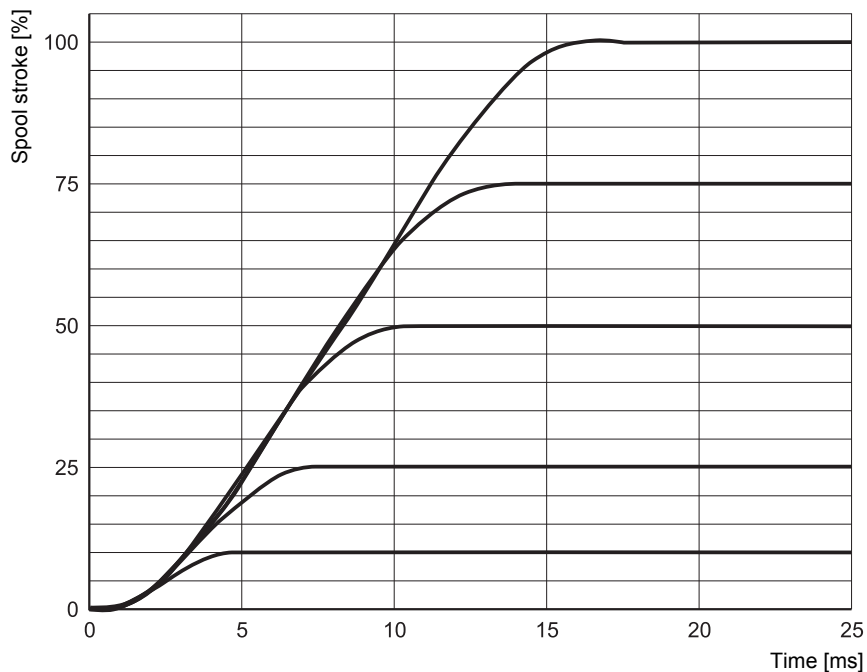

Step response  
of the spool stroke  
(D637K-R)

Fig. 25: Step response of the spool stroke for valves with  $Q_N = 100$  l/min (26 gpm)

<sup>1</sup> Typical characteristic curve  
(measured at operating pressure  $p_P = 140$  bar, viscosity of the hydraulic fluid  $\nu = 32$  mm<sup>2</sup>/s and temperature of the hydraulic fluid  $T = 40$  °C)

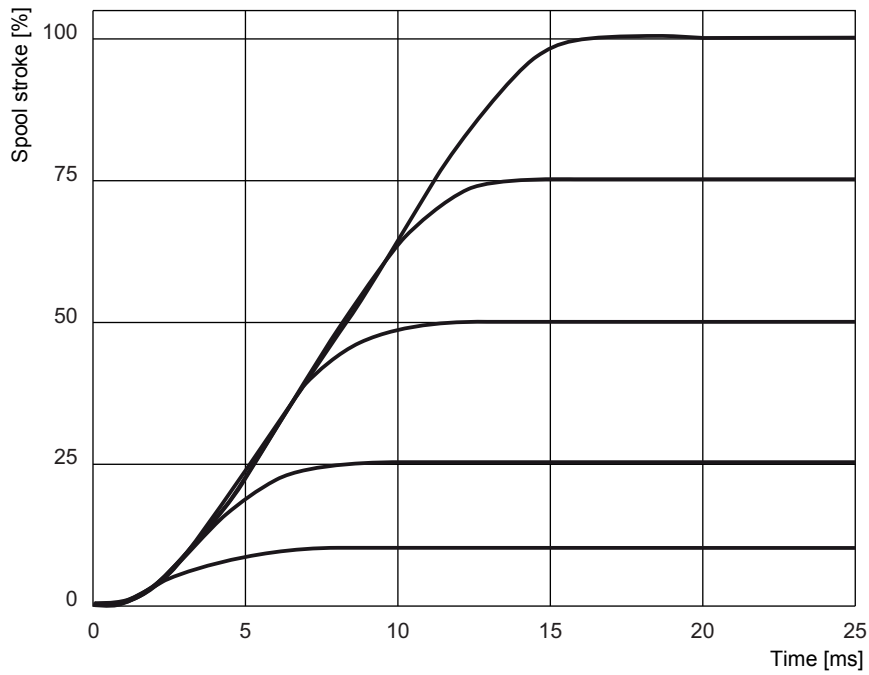

**Step response  
of the spool stroke  
(D637K-P/D639K-P)**

Fig. 26: Step response of the spool stroke for valves with  $Q_N = 80$  l/min (26 gpm)

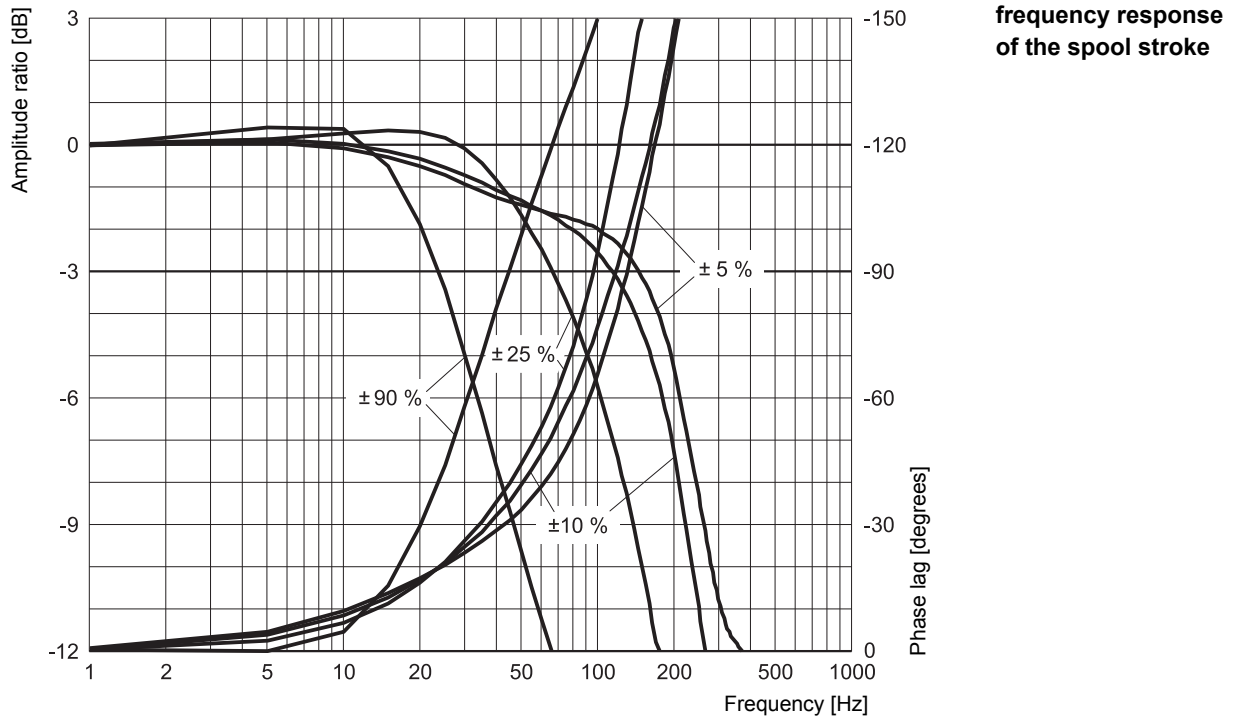

Fig. 27: Frequency response of the spool stroke for valves with  $Q_N = 60$  l/min (16 gpm)

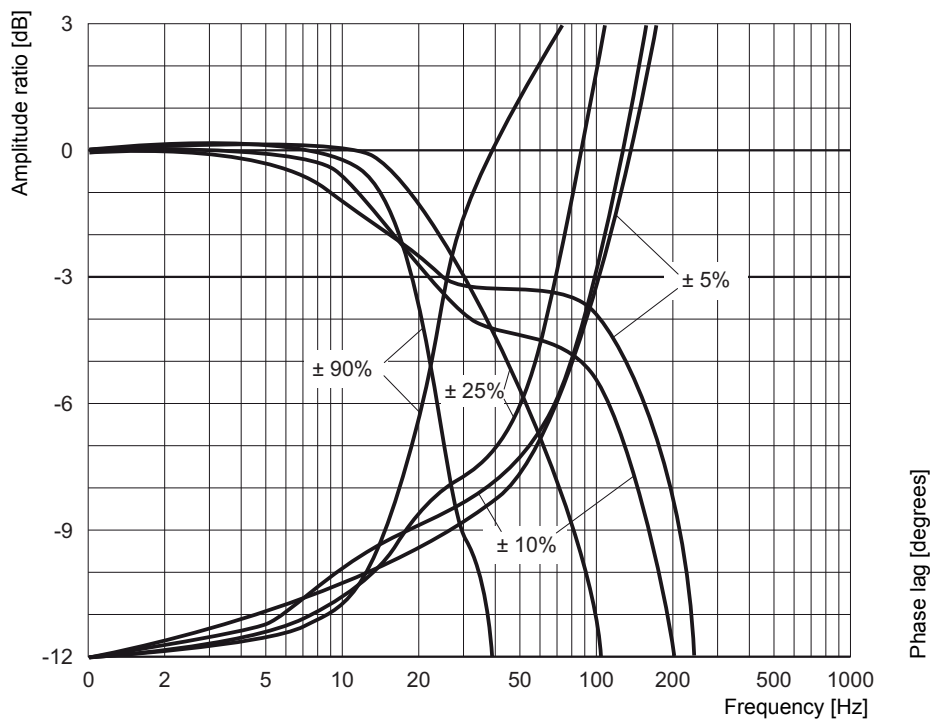

Fig. 28: Frequency response of the spool stroke for valves with  $Q_N = 80$  l/min with  $\Delta p=5$  bar

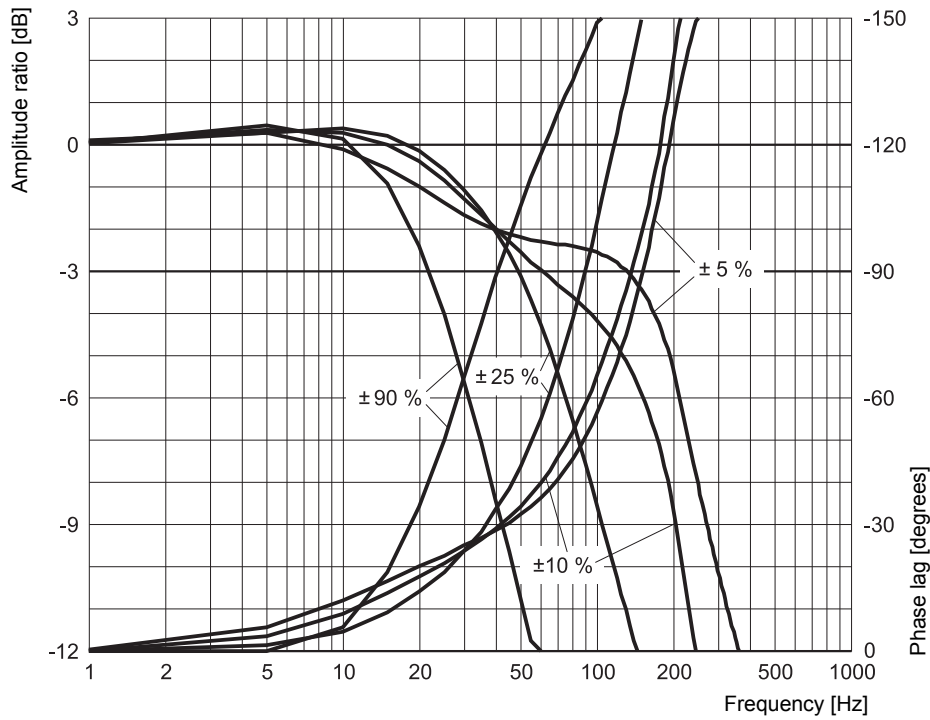

Fig. 29: Frequency response of the spool stroke for valves with  $Q_N = 100$  l/min (26 gpm)

## 5 Transportation and Storage

**Safety instructions:  
Transportation and  
Storage**

### WARNING



#### **Danger of property damage!**

In order to ensure perfect, reliable, and safe operation of the valves, heed the following:

- ▶ The valves must be protected in particular to prevent entry of dust and moisture.
- ▶ The permissible ambient conditions for the valves must be maintained at all times also in the case of transportation and storage.
- ▶ ⇒ [Chap. "11 Technical Data", page 164](#)

### WARNING



#### **Danger of explosion**

During transport and storage, cables on the valve, cable glands, screw plugs, and plug connectors must not be damaged.

- ▶ The valve must not be started up with damaged cables, plug connectors, and screw plugs, and it must be sent to us or to one of our authorized service centers immediately.

### CAUTION

#### **Risk of injury!**

To provide protection against injuries or other damaging influences on health, suitable protective measures must be taken if necessary prior to and when carrying out any work on the valves or the machine, such as mounting or removing, electrical or hydraulic connection, trouble shooting or servicing, and when handling the valves, accessories, tools or hydraulic fluids.

- ▶ ⇒ [Chap. "2.2 Occupational safety and health", page 15](#)

### CAUTION

#### **Risk of damage due to dirt and moisture!**

This is the only way of adequately protecting the valves against the penetration of dirt and moisture and protecting the gaskets/seals against the effects of ozone and UV.

- ▶ The valves must not be transported or stored without their shipping plate fitted.
- ▶ The valve shipping plate may only be removed from the valve hydraulic ports directly prior to mounting and must be reinstalled directly after the valve has been removed.
- ▶ The shipping plate and the associated fastening elements (screws and nuts) must be kept for later use, e.g. during transportation.

### CAUTION

#### **Risk of damage due to condensation!**

Due to temperature fluctuations during transport and storage of the valves, humidity may condense.

- ▶ Wait with the start-up of the valves until the valves have reached the ambient temperature
- 

### CAUTION

#### **Risk of damage!**

The plugs, connectors, and connection cables of the valves may not be used for other purposes, such as for stepping on or as transport holders.

---

### CAUTION



#### **Danger of personal injury and damage to property!**

Warranty and liability claims for personal injury and damage to property are excluded if they are caused by valves, spare parts or accessories having been stored or transported outside their original packaging.

- ▶ Store and transport valves, spare parts, and accessories only in properly-sealed original packaging.
  - ▶ ⇒ [Chap. "1.8 Warranty and liability", page 11](#)
- 

### CAUTION

#### **Risk of damage!**

Improper handling during transport or storage of the valves, spare parts, and accessories can cause damage to the original packaging and to the contents.

- ▶ After transporting or storing valves, spare parts and accessories, check the original packaging and contents for possible damage.
  - ▶ Do not start up the system if the packaging or contents show signs of damage. In this case, notify us or the supplier responsible immediately.
  - ▶ In the event of transportation damage, store the damaged packaging so that if necessary damages can be claimed from the transport contractor.
-

## 5.1 Checking/unpacking a delivery

### Procedure:

1. Check whether the packaging is damaged.
2. Remove packaging.
3. Keep damaged packaging so that damage claims can be lodged against the transport company.  
We recommend that you keep the original packaging for later transportation or storage operations.
4. Dispose of packaging material that is no longer needed according to the local specific disposal regulations and environmental protection provisions.
5. Check whether the contents of the packaging are damaged.
6. In case of damaged packaging or damaged content, inform us and the responsible supplier immediately.
7. Check whether the delivery matches the order and the delivery note.
8. In case of incorrect or incomplete delivery, inform us or the responsible supplier immediately.

### Procedure for checking/ unpacking a delivery

## 5.2 Scope of delivery of the valve

The scope of delivery of the valve consists of:

- Valve with mounted oilproof shipping plate at the hydraulic port
- 5 O-rings ID 12.4 x Ø 1.8 [mm] for ports A, B, P, T and T<sub>1</sub>
- 2 O-rings ID 15.6 x Ø 1.8 [mm] for port Y and O-ring recess X
- User manual for type series D637K/D639K

### Scope of delivery of the valve

## 5.3 Storage

The following effects may occur in the course of long-term storage:

- Gasket/seal materials become brittle, possibly resulting in leaks
- Hydraulic fluid becomes gummy, possibly resulting in friction

### Effects of long-term storage

In order to avoid possible resulting impairments or damage, we recommend that the valve, after a period of storage or operation of more than 5 years, be inspected by us or one of our authorized service centers.

## 6 Mounting and Connection to the Hydraulic System

### DANGER



#### **Danger of injury due to electric voltage and unexpected movements!**

Work on machines that are not shut down presents a danger to life and limb. Work such as mounting or removal, electrical or hydraulic connection, troubleshooting or service may only be performed on machines and valves that are shut down.

- ▶ Make sure to shut the machine down and switch it off.
- ▶ Make sure that the drive motor cannot be switched on.
- ▶ For this purpose, switch off the supply voltage as well as that of connected peripherals, such as externally powered transducers or programming units.
- ▶ Make sure that all power-transmitting components and connections (electrical and hydraulic) are switched off according to the manufacturer's instructions and secured against switching on again. If possible, remove the main fuse from the machine.
- ▶ Make sure that the machine is completely depressurized.

**Safety notes: Mounting and Connection to the Hydraulic System**

### DANGER



#### **Danger of poisoning and injury due to hydraulic fluid squirting out under pressure!**

Contact with hydraulic fluids can damage your health (e.g. eye injuries, skin and tissue damage, poisoning in case of inhaling).

- ▶ Wear protective gloves and safety glasses.
- ▶ If hydraulic fluid gets into your eyes or on your skin, consult a doctor immediately.
- ▶ When handling hydraulic fluids, observe the safety provisions applicable to the hydraulic fluid used.

### WARNING



#### **Danger of explosion**

For mounting and connection to the hydraulic system, cables on the valve, cable glands, screw plugs, and plug connectors must not be damaged.

- ▶ The valve must not be started up with damaged cables, plug connectors, and screw plugs, and it must be sent to us or to one of our authorized service centers immediately.

### WARNING



#### **Risk of injury!**

To provide protection against injuries or other damaging influences on health, suitable protective measures must be taken if necessary prior to and when carrying out any work on the valves or the machine, such as mounting or removing, electrical or hydraulic connection, trouble shooting or servicing, and when handling the valves, accessories, tools or hydraulic fluids.

- ▶ ⇒ [Chap. "2.2 Occupational safety and health", page 15](#)



## CAUTION

### **Danger of personal injury and damage to property!**

Working with and on the valves without the required basic mechanical, hydraulic, and electrical knowledge may cause injuries or parts may be damaged.

- ▶ Only properly qualified and authorized users may work with and on the valves.
  - ▶ ⇒ [Chap. "1.4 Selection and qualification of personnel"](#), page 7
-

## 6.1 Dimensions (installation drawings)

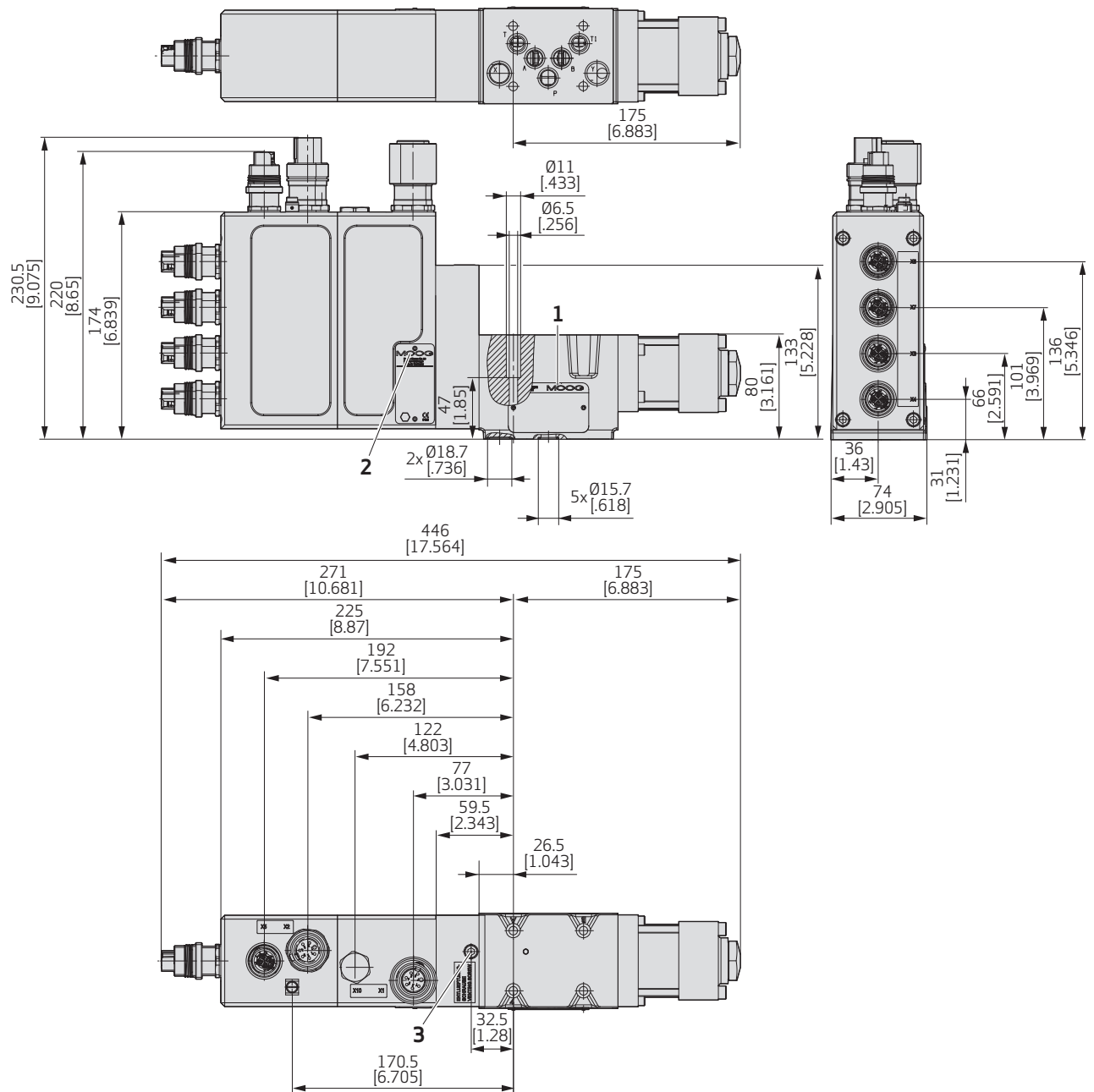

Item	Designation	Additional information
1	Nameplate	⇒ Fig. 11.1, page 165
2	Ex nameplate	⇒ Fig. 67, page 166
3	Venting screw	The venting screw is only present for valves of the D639K type series. ⇒ Chap. "8.5.1 Venting", page 142

Fig. 30: Installation drawing for valves with CAN bus interface (dimensions in mm)

Installation space for the connector when mounted: ⇒ Fig. 33, page 74

- Hydraulic symbols: ⇒ Chap. "3.3.2 Valve configurations and hydraulic symbols", page 35
- Procedure for mounting the valve: ⇒ Chap. "6.3.3 Procedure", page 66
- Position of the ports: ⇒ Chap. "6.2.2 Mounting pattern of mounting surface", page 64

## 6.2 Mounting surface



If the valve is mounted on the mounting surface, it projects over the mounting surface.

⇒ Chap. "6.1 Dimensions (installation drawings)", page 63

### 6.2.1 Surface quality

Evenness as per EN ISO 1302: < 0.01 mm (400 µin) over 100 mm (3.94 in)

Average roughness  $R_a$  according to

EN ISO 1302: < 0.8 µm (30 µin)

**Evenness and roughness  
of the mounting surface**

### 6.2.2 Mounting pattern of mounting surface



Contrary to ISO 4401-05-05-0-05 the length of the mounting surface must be at least 100 mm (3.94 in) so that the required O-ring recesses can be covered on ports X and Y.

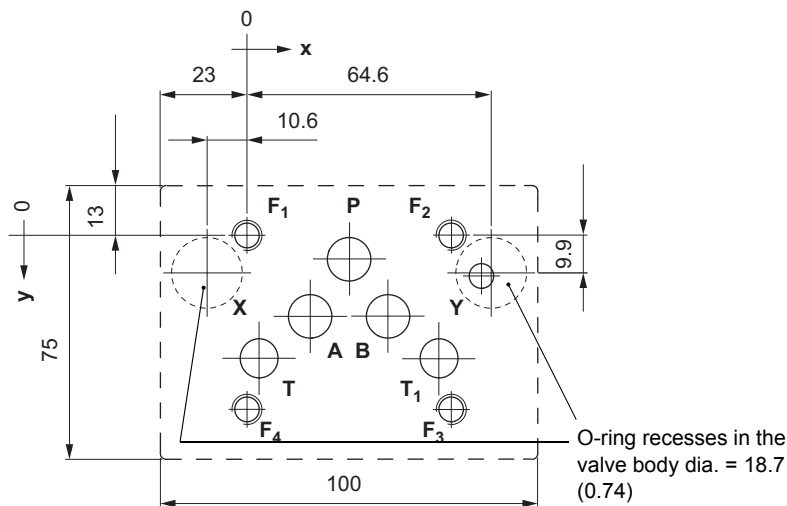

**Mounting pattern  
of mounting surface**

	P	A	T	T <sub>1</sub> optional	B	F <sub>1</sub>	F <sub>2</sub>	F <sub>3</sub>	F <sub>4</sub>	X	Y
	dia. 11.2 (0.44)	dia. 11.2 (0.44)	dia. 11.2 (0.44)	dia. 11.2 (0.44)	dia. 11.2 (0.44)	M6	M6	M6	M6	-	dia. 6.3 (0.25)
X	27 (1.06)	16.7 (0.66)	3.2 (0.13)	50.8 (2.00)	37.3 (1.47)	0	54 (2.13)	54 (2.13)	0	-	62 (2.44)
Y	6.3 (0.25)	21.4 (0.84)	32.5 (1.28)	32.5 (1.28)	21.4 (0.84)	0	0	46 (1.81)	46 (1.81)	-	11 (0.43)

Fig. 31: Hole pattern of the mounting surface according to ISO 4401-05-05-0-05, dimensions in mm and (in).

## 6.3 Mounting the valve

### 6.3.1 Tools and materials required

The following tools and materials are required for mounting the valves:

- For removing the shipping plate  
Regular screwdriver 8x1.6 [mm] and if necessary wrench WS 10
- For mounting the valve  
Torque wrench for 5 WAF hexagon socket screws
- Installation screws  
⇒ [Chap. "6.3.2 Specification for installation screws", page 65](#)
- Replacement for O-rings of ports to be replaced if necessary  
⇒ [Chap. "12.2 Spare parts", page 175](#)

**Required tools and materials for mounting the valves**



The installation screws and the O-rings to be replaced if necessary are not included in the scope of delivery for the valves. They are available as an accessory.

⇒ [Chap. "12 Accessories and spare parts", page 173](#)

### 6.3.2 Specification for installation screws

Hexagon socket head cap screws as per <a href="#">EN ISO 4762</a>		Quality class	Number required	Tightening torque
D637K-R/D639K-R	M6x60	10.9	4	11 Nm ± 10 % / 8 lbf ft +/- 10%
D637K-P/D639K-P	M6x40	10.9	4	11 Nm ± 10 % / 8 lbf ft +/- 10%

**Specification for installation screws**

Tab. 7: Specification for installation screws

### 6.3.3 Procedure

#### CAUTION

**Danger of personal injury and damage to property!**

The shipping plate attachment screws must not under any circumstances be used to mount the valve.

- ▶ Use only the installation screws specified here for mounting the valve.
- ▶ The fastening of the valve with non-specified, unsuitable screws can be destroyed under pressure.

**Safety notes: mounting the valves**

#### CAUTION

**Risk of damage due to dirt and moisture!**

This is the only way of adequately protecting the valves against the penetration of dirt and moisture and protecting the gaskets/seals against the effects of ozone and UV.

- ▶ The valves must not be transported or stored without their shipping plate fitted.
- ▶ The valve shipping plate may only be removed from the valve hydraulic ports directly prior to mounting and must be reinstalled directly after the valve has been removed.
- ▶ The shipping plate and the associated fastening elements (screws and nuts) must be kept for later use, e.g. during transportation.

#### CAUTION

**Danger of explosion and risk of damage due to overheating!**

In order to prevent overheating of the valves.

- ▶ Mount the valves so that good ventilation is ensured.
- ▶ The maximum permissible temperatures of the respective temperature classes and the maximum permissible ambient temperature as well as the maximum permissible temperature of the hydraulic fluid may not be exceeded.
- ▶ ⇒ [Chap. "1.3 Intended operation", page 5](#)

#### CAUTION

**Risk of damage!**

Vibrations and shocks can damage the valve.

- ▶ Do not mount the valve directly on machine parts that are exposed to strong vibrations or sudden movement.
- ▶ On units that are moved in jerks and jolts, the movement direction of the spool should not be the same as the movement direction of the unit.

**CAUTION****Increased wear and functional faults!**

The cleanliness of the connection and mounting surface influences the cleanliness and the life cycle of the valve. Soiling causes wear and functional faults.

- ▶ Make sure the valve is extremely clean.
- ▶ Install the valve dirt-free.
- ▶ Make sure that connections and attachments are clean.
- ▶ Do not use steel wool or cloths with lint for cleaning.
- ▶ Do not use any cleaning agents or methods that could attack the surfaces or the O-rings mechanically or chemically.



Mount the valves with venting screw in such a way that it can be vented.

The venting screw must point upwards.

⇒ [Chap. "8.5.1 Venting", page 142](#)

⇒ [Fig. 1, page 18](#)

**Procedure:**

1. Clean the valve mounting and connecting surfaces.  
Check and if necessary correct the evenness and roughness of the mounting surface.  
⇒ [Chap. "6.2.1 Surface quality", page 64](#)
2. Remove the shipping plate from the valve's hydraulic port.  
The shipping plate and the associated fastening elements (screws and nuts) must be kept for later use, e.g. during transportation.
3. Check that O-rings in the valve ports (A, B, P, T, etc.) are present and for elasticity, integrity and correct seating.  
If necessary, install O-rings, replace or correct the seating.
4. Paying attention to the mounting pattern, place the valve on the mounting surface and align with the mounting bores.
5. Secure the valve. To do so, tighten the installation screws (hexagon socket head cap screws) free from distortion in diagonal sequence.  
Tightening torque: 11 Nm ± 10 % / 8 lbf ft +/- 10 %  
⇒ [Chap. "6.3.2 Specification for installation screws", page 65](#)

**Procedure for mounting the valves**

## 7 Electrical connection

### 7.1 Safety instructions for installation and maintenance

#### DANGER

**Danger of explosion!**

An explosion can be triggered by sparks when switching on the machine.

- ▶ Open connectors for the interface must absolutely be covered before start-up.
- ▶ The eXLink connectors from CEAG must be mounted according to the instructions in the operating instructions for the eXLink connector.
- ▶ In its standard model with screw plug, the service connector X10 is not permitted for use in hazardous area.
- ▶ The service connector X10 in the standard model M8, 3-pin must be sealed with the original screw plug belonging to the valve before start-up.
- ▶ For mounting of the screw plug of the service connector X10, it must be observed that the gasket and the threads of the screw plug as well as the threads in the electronic housing of the valve are not damaged.
- ▶ In case of damage to the screw plug of the service connector X10 or the threads in the electronic housing, the valve must not be operated.
- ▶ Tightening torque screw plug:  
⇒ [Chap. "3.1.2 Representative depiction of the valve", page 18](#)

#### WARNING

**Danger of explosion**

For the electrical connection of the valve, cables, cable glands, screw plugs, and connectors must not be damaged.

- ▶ The valve must not be started up with damaged cables, connectors, and screw plugs, and it must be sent to us or to one of our authorized service centers immediately.

#### WARNING

**Danger of explosion**

To guarantee safe operation in hazardous area:

- ▶ The signal interfaces of the valve are implemented with explosion-proof connectors.
- ▶ For mounting and removal of the connectors as well as operation of the valve, the notes and instructions in the "Explosion-proof connectors eXLink, CEAG" operating instructions must absolutely be adhered to.

**CAUTION****Danger of personal injury and damage to property from interchanged connections!**

Interchanging connections causes unforeseeable movements of the machine and thus corresponding risks to people and equipment.

- ▶ When starting up valves on the field bus for the first time, we recommend that the component be operated in a depressurized state.
- ▶ Before connecting valves to the field bus, it is essential to complete the electrical and if necessary hydraulic connection of the component properly as described in the user manual.

**CAUTION****Danger of personal and property damage due to defective accessories and defective spare parts!**

Unsuitable or defective accessories or unsuitable or defective spare parts may cause damage, malfunctions or failure of the valve or the machine.

- ▶ Use only original accessories and original spare parts.

**CAUTION****Danger of personal injury and damage to property!**

Improperly laid connection cables can cause damage, malfunctions or failure of valves or the machine.

- ▶ Do not lay valve connection cables in the immediate vicinity of high-voltage cables or together with cables that switch inductive or capacitive loads.

**CAUTION****Danger of personal injury and damage to property!**

For the floating analog inputs of connector X1, the potential difference (referenced to supply zero) must be between -15 V and 32 V.

- ▶ Only use SELV/PELV power supplies.
- ▶ Heed the correct dimensioning of the cables.

**CAUTION****Danger of personal injury and damage to property!**

In the signal range 4–20 mA input currents < 3 mA can cause faulty reactions with digital valves.

- ▶ Examine the connection cables for defects.



**CAUTION****Risk of valve electronic damage!**

In the signal range 4–20 mA command signals  $I_{in} < 3 \text{ mA}$  (e.g. due to a faulty electric cable) indicate a fault.

- ▶ The valve response to this fault can be set and activated via the service or field bus interface in the valve software. Setting and activation can, for example, take place with the Moog Valve and Pump Configuration Software.
- ▶ Examine the connection cables for defects.

**CAUTION****Risk of valve electronic damage!**

The input current must be between -25 mA and 25 mA. Input currents outside this permissible range will destroy the input.

- ▶ Only use SELV/PELV power supplies.
- ▶ Heed the correct dimensioning of the cables.



The valves described here must only be operated with external fuse protection. The information about the external fuse protection of the valves is included in Chapter 11. ⇒ [Tab. 28, Seite 171](#)

## 7.1.1 Protective grounding and electrical shielding

### DANGER



#### **Danger of explosion in case of unsafe operation!**

In order to create as small a potential difference in the machine and to guarantee safe operation of the machine, the equipotential bonding and protective conducting system for a machine in which the valves should be used must be constructed according to EN 60204-1.

- ▶ Connect all elements of the machine to each other via equipotential bonding conductors.
- ▶ Connect all elements of the machine that have exposed metal surfaces via protective conductors to the protective conductor rail.
- ▶ Connect all the protective conductors and the equipotential bonding conductor in the main cabinet via the protective conductor rail to the protective earth (PE) terminal.

**Equipotential bonding/  
protective conductor  
system**

### DANGER



#### **Danger to life!**

People can be injured and property damaged through the operation of the valve with an unsafe power supply.

- ▶ Only use SELV/PELV power supplies as per EN 60204-1!

### DANGER



#### **Danger to life due to electric shock!**

Very strong current can flow via the shield connection of the valve.

- ▶ Extreme caution is required since for some industrial applications, no good equipotential bonding can be implemented.
- ▶ An effective equipotential bonding system must be set up in compliance with EN 60204-1, Section 8.

## 7.1.2 Moog Valve and Pump Configuration Software

### CAUTION

**Danger of personal injury and damage to property!**

Improper handling of the Moog Valve and Pump Configuration Software causes malfunctions and thus corresponding risks to people and equipment.

- ▶ For safety reasons, the Moog Valve and Pump Configuration Software must not be used inside a machine for visualization purposes or as an operator terminal.

### CAUTION

**Danger of personal injury and damage to property!**

It is not permitted to operate the Moog Valve and Pump Configuration Software on a field bus while the machine is running.

It is only permitted to activate valves via the Moog Valve and Pump Configuration Software if this does not cause any dangerous states in the machine and in its surroundings.

### CAUTION

**Danger of personal injury and damage to property!**

Activating valves via the Moog Valve and Pump Configuration Software within a network can give rise to unforeseeable events if field bus communication takes place simultaneously between the machine control or other bus nodes!

- ▶ Deactivate the field bus communication for machine control and other bus nodes.

### CAUTION

**Danger of personal injury and damage to property!**

Messages from the Moog Valve and Pump Configuration Software can also be received by other bus nodes. This may trigger unforeseeable events.

- ▶ Deactivate the field bus communication for machine control and other bus nodes.

### CAUTION

**Danger of personal injury and damage to property!**

If danger-free operation of the valves via the Moog Valve and Pump Configuration Software can also not be ensured with deactivated field bus communication to the machine control and other bus nodes, the following must be heeded:

- ▶ The valves may only communicate depressurized and in a direct connection (point-to-point) with the Moog Valve and Pump Configuration Software.

**CAUTION****Data loss!**

Data communication between the valve electronics and the Moog Valve and Pump Configuration Software may be disrupted if other field bus nodes (e.g. a controller) are accessing the valve electronics at the same time.

- ▶ Deactivate the field bus communication for machine control.

**7.2 Block diagram**

Fig. 32: Block diagram of the valve electronics

\* Depending on the model, the valves can have different electrical connections.

## 7.3 Arrangement of connectors

The depiction of the electronics housing is exemplary for all sizes.

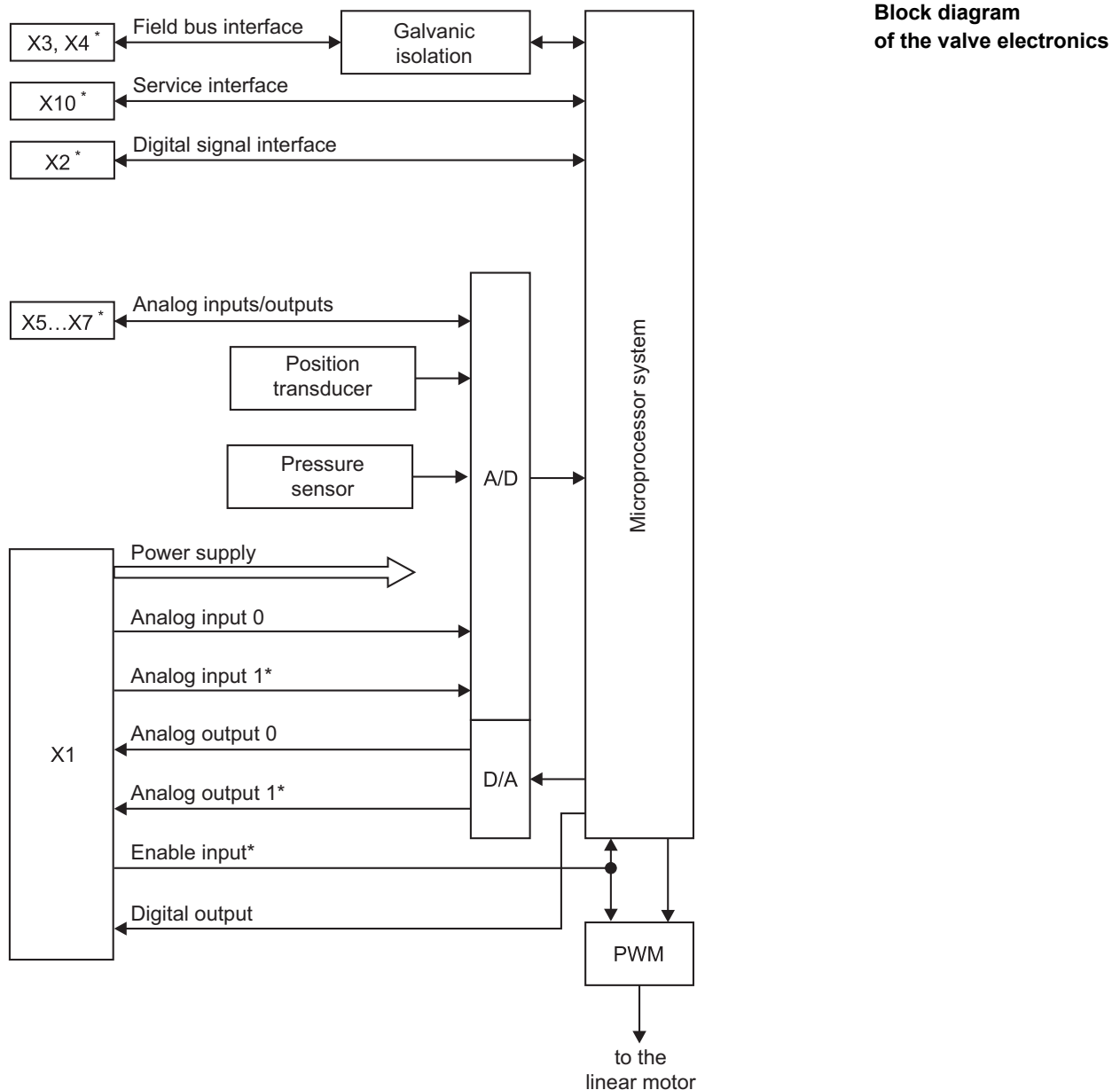
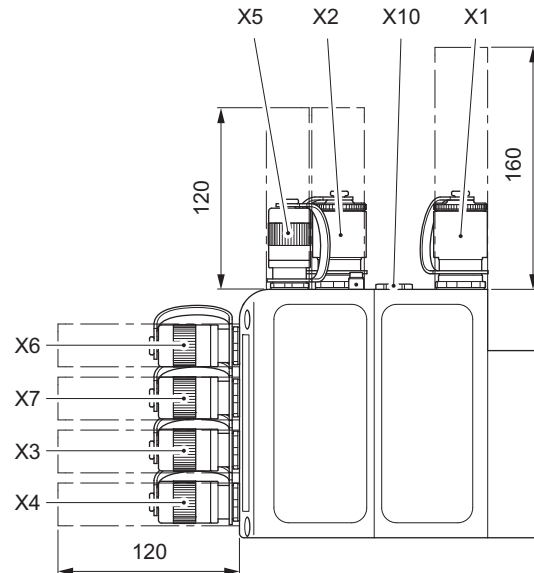

**Arrangement of connectors on the valve electronics housing (maximum equipment specification)**

Fig. 33: Arrangement of connectors on the valve electronics housing (maximum equipment specification)

X1	Connectors, analog signals and supply voltage ⇒ Chap. "7.4 Connector X1", page 76
X2	Connectors, digital signal interfaces are optionally available, must be specified on order. ⇒ Chap. "7.7 Digital signal interface", page 82
X3 X4	The field bus connectors X3 and X4 are only provided on valves with field bus interfaces and are optionally available, this must be specified on order. ⇒ Chap. "7.8 Field bus connectors X3 and X4", page 84
X5 X6 X7	Connectors, analog signals ⇒ Chap. "7.9 Analog input connectors X5, X6 and X7", page 90
X10	The X10 service connector is only present for valves without CAN bus interface. By default, the X10 service connector is not approved for use in hazardous area, however on request it is available for use in hazardous area. ⇒ Chap. "7.10 Service connector X10", page 93

### Allocation of interfaces to connectors

The valve electronics are equipped with connectors that are designated X1 through X10.

The table below shows which interfaces are accommodated in the different connectors.

Interface type	Interface	Connector
Analog input	Analog input 0	X1
	Analog input 2	X5
	Analog input 3	X6
	Analog input 4	X7
Analog output	Analog output 0	X1
Digital input	Digital input 0	X1
Digital output	Digital output 0	X1
Digital signal interface	SSI transducer	X2
Field bus interface	CANopen, Profibus-DP, EtherCAT	X3, X4
Service interface		X10

Tab. 8: Allocation of interfaces to connectors



The availability of the interface depends on the model.

### Allocation of interfaces to connectors

## 7.4 Connector X1

Connector X1 is designed in accordance with [EN 175201-804](#) and is available in the following versions:

- 7-pin connector with protective conductor contact

### 7.4.1 Pin assignment of connector X1

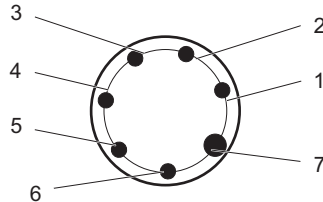

View of male receptacle X1 on the valve (internal thread, pin contacts)

**Pin assignment of connector X1 (7-pin) p/Q valves and Q valves**

Contact	Assignment	Description
1	Analog input 0	Current or voltage input referenced to pin 2, setpoint Q
2	Reference point for analog input 0 and 1	Reference point for pins 1 and 3
3	Analog input 1	Current or voltage input referenced to pin 2, setpoint p
4	Analog output 0	4–20 mA or 2–10 V referenced to GND, actual value Q
5	Analog output 1	4–20 mA or 2–10 V referenced to GND, actual value p
6	supply voltage	Nominal 24 V (18–23 V) DC based on GND
7	GND, supply zero or signal zero	GND ⇒ <a href="#">Chap. "7.12 Protective grounding and electrical shielding", page 97</a>

Fig. 34: Pin assignment connector X1 (7-pin) p/Q valves

Contact	Assignment	Description
1	Analog input 0	Current or voltage input referenced to pin 2, setpoint Q
2	Reference point for analog input 0	Reference point for pin 1
3	Digital enable input	Enable referenced to GND
4	Analog output 0	4–20 mA or 2–10 V referenced to GND, actual value Q
5	Digital output 0 (standby), optional digital output 1 (monitoring)	Standby monitoring referenced to GND
6	supply voltage	Nominal 24 V (18–23 V) DC based on GND
7	GND, supply zero or signal zero	GND ⇒ <a href="#">Chap. "7.12 Protective grounding and electrical shielding", page 97</a>

Fig. 35: Pin assignment connector X1 (7-pin) Q valves

⇒ [Chap. "7.14 Wiring connector X1", page 110](#)

### 7.4.2 Mating connector for connector X1

The mating connector for the 7-pin connector X1 is available as an accessory.

⇒ [Chap. "12.1 Accessories", page 173](#)

⇒ [Chap. "7.13 Permissible lengths for connection cables", page 105](#)

**Mating connector for connector X1**

## 7.4.3 Power supply

### CAUTION

#### Risk of personal injury due to insufficient electrical safety

The insulating elements used are designed for the safety extra low voltage range. The circuits of the field bus connections, if provided, are only functionally isolated from other connected circuits.

Compliance with the safety regulations requires that the equipment be isolated from the mains system in accordance with [EN 61558-1](#) and [EN 61558-2-6](#) and that all voltages be limited in accordance with [EN 60204-1](#).

- ▶ Nominal signal: see nameplate.
- ▶ Only use SELV/PELV power supplies!

### CAUTION

#### Risk of EMC damage!

Improper electrical connections can damage the valve electronics and destroy the field bus communication.

- ▶ Make the electrical connection so that it is EMC-appropriate.

The supply voltage must be nominally 24 V (18–32 V) DC referenced to supply zero. Supply voltages of less than 18 V are detected by the valve electronics as undervoltage.

The valve electronics are protected against polarity reversal of the connections.

The power consumption of the valves varies from model to model.



Detailed information can be found in the product-specific valve user manual.

### Requirement of supply voltage

## 7.5 Analog inputs/outputs

The analog inputs/outputs are available on connector X1 and the analog inputs optionally on connectors X5, X6 and X7. The analog inputs can measure both current and voltage.

### Analog inputs/outputs

### 7.5.1 Analog inputs

All current and voltage inputs are differential, but can be connected to ground (single-ended) by means of external wiring. The analog inputs of connector X1 have a resolution of 12 bits.

⇒ [Chap. "7.14.1 Single-ended command signals", page 110](#)



### 7.5.1.1 Signal types

The analog inputs are available in the following versions:

- $\pm 10$  V
- 0–10 V
- $\pm 10$  mA
- 0–10 mA
- 4–20 mA

**Signal types of the analog inputs on connector X1**

Which signal type is set for the analog inputs on delivery depends on the valve model. The signal types can be configured via the firmware.



Detailed information can be found in the "Firmware" User Manual.

#### Signal type for the analog input: $\pm 10$ V

In the case of this signal type, the input is configured as a differential voltage input with a  $\pm 10$  V input range.

**Analog input:  $\pm 10$**

The differential input resistance is 20 k $\Omega$ .

The input resistance referenced to supply zero is approx. 150 k $\Omega$ .

The potential difference of each input to supply zero must be between -15 V and 32 V.

If there is no differential analog source available, the reference point of the analog input (pin 5) must be connected to 0 V of the analog source.

#### Signal type for the analog input: 0–10 V

In the case of this signal type, the input is configured as a differential voltage input with a 0–10 V input range.

**Analog input: 0–10 V**

The differential input resistance is 20 k $\Omega$ .

The input resistance referenced to supply zero is approx. 150 k $\Omega$ .

The potential difference of each input to supply zero must be between -15 V and 32 V.

If there is no differential analog source available, the reference point of the analog input (pin 5) must be connected to 0 V of the analog source.

**Signal type for the analog input:  $\pm 10$  mA**

With this signal type, the input current to be measured is directed via the two input pins to an internal shunt.

**Analog input:  $\pm 10$  mA**

The differential input resistance is 200 k $\Omega$ .

The input resistance referenced to supply zero is approx. 150 k $\Omega$ .

**CAUTION****Risk of valve electronic damage!**

The input current must be between -25 mA and 25 mA. Input currents outside this permissible range will destroy the input.

- ▶ Only use SELV/PELV power supplies.
- ▶ Heed the correct dimensioning of the cables.

The potential difference of each input to supply zero must be between -15 V and 32 V.

If there is no floating analog source available, the reference point of the analog input (pin 5) must be connected to 0 V of the analog source.

**Signal type for the analog input: 0–10 mA**

With this signal type, the input current to be measured is directed via the two input pins to an internal shunt.

**Analog input: 0–10 mA**

The differential input resistance is 200 k $\Omega$ .

The input resistance referenced to supply zero is approx. 150 k $\Omega$ .

**CAUTION****Risk of valve electronic damage!**

The input current must be between -25 mA and 25 mA. Input currents outside this permissible range will destroy the input.

- ▶ Only use SELV/PELV power supplies.
- ▶ Heed the correct dimensioning of the cables.

The potential difference of each input to supply zero must be between -15 V and 32 V.

If there is no floating analog source available, the reference point of the analog input (pin 5) must be connected to 0 V of the analog source.

**Signal type for the analog input: 4–20 mA**

With this signal type, the input current to be measured is directed via the two input pins to an internal shunt.

**Analog input: 4–20 mA**

The differential input resistance is 200 k $\Omega$ .

The input resistance referenced to supply zero is approx. 150 k $\Omega$ .

**CAUTION****Risk of valve electronic damage!**

The input current must be between -25 mA and 25 mA. Input currents outside this permissible range will destroy the input.

- ▶ Only use SELV/PELV power supplies.
- ▶ Heed the correct dimensioning of the cables.

The potential difference of each input to supply zero must be between -15 V and 32 V.

If there is no floating analog source available, the reference point of the analog input (pin 5) must be connected to 0 V of the analog source.

In the 4–20 mA signal range signals of  $I_{in} < 3$  mA (e.g. due to a defective electric cable) signify a fault, which can be evaluated by the valve software. The monitoring must be activated in the valve software.

**7.5.2 Analog outputs****Analog outputs 4–20 mA**

The reference point for the 4–20 mA analog outputs is supply zero.

**Analog output: 4–20 mA**

The load impedance must be in the range of 0–500  $\Omega$ .

Cable break detection of the connected cable can be effected with the 4–20 mA analog outputs.

The 4–20 mA analog outputs are short-circuit protected.

**Analog outputs 2–10 V**

The reference point for the 2–10 V analog outputs is supply zero.

**Analog output: 2–10 V**

The internal resistance is 500  $\Omega$ .

Cable break detection of the connected cable can be effected with the 2–10 V analog outputs.

Voltage drops in the supply cable to the valve electronics can result in deviations from the actual value.

⇒ [Chap. "7.14.1 Single-ended command signals", page 110](#)

Recommendation: Use a 4–20 mA analog output and terminate directly at the measurement input with 500  $\Omega$ .

⇒ [Chap. "7.14.2 Conversion of actual value output signals  \$I\_{out}\$ ", page 111](#)

## 7.6 Digital inputs/outputs

The digital inputs/outputs are available on connector X1 depending on the model. The digital input serves as the enable input. The digital outputs indicate specific events, such as for example the occurrence of a fault.

### Digital inputs/outputs

### 7.6.1 Digital inputs

#### Digital enable input

Signals between 8.5 V and 32 V supply voltage referenced to supply zero at the enable input are identified as an enable signal.

#### Enable input

Signals of less than 6.5 V at the enable input are identified as enable not issued. The electrical output stage is deactivated if no enable is issued.

This input is also used to acknowledge a valve fault state via an analog signal.

The input current of the digital enable input is 2.3 mA when connected to 24 V.



Detailed information can be found in the "Firmware pQ" user manual.

### 7.6.2 Digital outputs

The digital outputs are short-circuit protected and switch off in the event of overload. After a period of cooling down, the digital output switches itself back on. Overload means a current load in excess of 1.5 A. However, the total current consumption of the valve must be limited by a fuse.

#### Valve standby

High Supply voltage connected.

Low Supply voltage disconnected (10 k $\Omega$  to supply zero).

#### Logic level

## 7.7 Digital signal interface

The digital signal interface is available on connector X2.  
A digital transducer can be connected to this signal interface.

Connector X2 is available in the following versions:

- 7-pin SSI transducer connector X2  
⇒ [Chap. "7.7.1 SSI transducer", page 82](#)

### 7.7.1 SSI transducer

This digital signal interface is suitable in accordance with [EIA 422](#) for connecting e.g. position transducers or rotary transducers with an SSI interface.  
⇒ [Chap. "7.15 Wiring SSI transducers \(X2\)", page 112](#)

The following transducer types are supported:

- Coded with binary code
- Coded with Gray Code

**Supported types  
of SSI transducers**

The digital signal interface must be configured.



Detailed information can be found in the "Firmware" User Manual.

The signal levels conform to the standard [EIA 422](#).

#### Recommended cable types

Use exclusively shielded cables with copper braiding shielding with min. 80% overlap.  
Copper conductors with a cross section of at least 0.25 mm<sup>2</sup>.  
Use cables with twisted-pair conductors in environments with high background noise levels.

**Recommended cable  
types for SSI transducer**

#### Cable break monitoring

Inputs CLK and DATA of the digital signal interfaces are monitored for cable break – regardless of which transducer type is connected.  
The status of cable break monitoring can be read out via field bus. The reaction to a cable break is configurable.

**Cable break monitoring**



Detailed information can be found in the "Firmware" User Manual.

### 7.7.1.1 Pin assignment SSI transducer connector X2

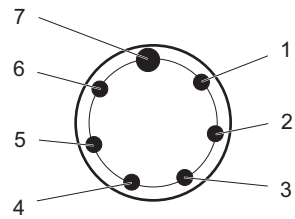

**SSI transducer  
connector X2**

View of the SSI encoder female  
receptacle X2 on the valve  
(external thread, socket contacts)

Contact	Assignment	Description
1	CLK+	Clock pulse output
2	CLK-	
3	DATA+	Data input for transducer data
4	DATA-	
5	SensorSup	Supply voltage to SSI transducer 24 V / 5 V / 0 V (configurable; see "Firmware" User Manual) $I_{\max} = 300 \text{ mA}$
6	GND	Supply zero
7		not used

Fig. 36: SSI transducer connector X2 (6+PE-pin)

#### Power supply to the transducer

Power is supplied to the transducer via pin 5 on connector X2.

#### Power supply to the transducer



There is joint fusing of this power supply for X2, X5, X6 and X7.  
The total supply current must therefore not exceed the following  
value:

$$I_{\max} (X2+X5+X6+X7) = 300 \text{ mA}$$

The 24 V or 5 V supply voltage is configurable (see "Firmware" User Manual).  
An external power supply to the transducer is also possible. However, the 0 V  
transducer supply must be connected to supply zero.

The supply voltage is cut off in the event of a possible short circuit in the supply  
voltage to the transducer. A fault reaction can be configured (see "Firmware"  
User Manual). The voltage is available again as soon as the short circuit has  
been eliminated.

## 7.8 Field bus connectors X3 and X4

Field bus connectors X3 and X4 are available in the following versions:

- 4-pin CAN connector  
⇒ Chap. "7.8.1 CAN connectors", page 84
- 4-pin Profibus-DP connector  
⇒ Chap. "7.8.2 Profibus-DP connectors", page 85
- 4-pin EtherCAT connector  
⇒ Chap. "7.8.3 EtherCAT connectors", page 87

### Versions of the field bus connector

### 7.8.1 CAN connectors

The CAN bus has the following features:

- Multi-master system: Each node can transmit and receive
- Topology: Line structure with short stub lines
- Network expansion and transmission rates:  
25 m at 1 Mbit/s to 5,000 m at 25 kbit/s
- Addressing type: Message-orientated via identifiers  
Priority assignment of messages possible via identifiers
- Security: Hamming distance = 6, i.e. up to 5 individual errors per message are detected
- Physical Bus: [ISO 11898](#)
- Max. nodes: 127 (via repeater)

#### 7.8.1.1 Technical data for the CAN bus interface

<b>EMC protection requirements</b>	Immunity to interference as per <a href="#">EN 61000-6-2</a> (evaluation criterion A) Emitted interference as per <a href="#">EN 61000-6-4</a>
<b>Connectors X3 and X4</b>	In each case a 4-pin plug connector with socket connectors (eXLink plug connector Fa. CEAG, coding 1h) ⇒ Chap. "7.8.1.2 Pin assignment, CAN connectors", page 85
<b>Physical</b>	<a href="#">ISO 11898</a> CAN-HIGH SPEED
<b>Maximum voltage capacity</b>	±40 V long-term (between CAN_H and CAN_L) ±500 V long-term referenced to supply zero (optical isolation) ±2.5 ESD (classification A: Human Body Model, C = 100 pF, R = 1.5 kΩ)
<b>Maximum permissible number of CAN bus nodes</b>	32 or 110 ⇒ Chap. "7.16.2 Permissible number of CAN bus nodes", page 117

Tab. 9: Technical data for the CAN bus interface

### 7.8.1.2 Pin assignment, CAN connectors

#### CAN connectors X3 and X4

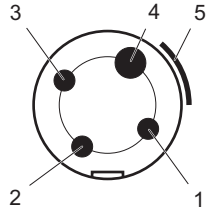

View of CAN female receptacle X3 and X4 on the valve (external thread, socket contacts)

Contact	Assignment	Description
1	CAN_V+	Not connected in the valve
2	CAN_GND	CAN terminal resistor
3	CAN_H	Transceiver H
4	CAN_L	Transceiver L
5	CAN_SHLD	Screen (applied on the control cabinet side)

Fig. 37: CAN connectors X3 and X4

#### CAUTION

#### Danger of property damage due to improper plug connection!

In order to avoid damage to the explosion proof connector:

- ▶ Heed the notes and instructions in the "Ex connector eXLink" operating instructions.

### 7.8.2 Profibus-DP connectors

The Profibus-DP has the following features:

- Standardized in accordance with [EN 61158-2](#) (type 3)
- Multi-master system:  
Masters share access time and initiate communication.  
Slaves react only on request.
- Topology: Line structure with short stub lines
- Network expansion and transmission rates:  
100 m at 12 Mbit/s to 1,200 m at 9.6 kbit/s per segment  
Use of repeaters possible
- Addressing type: address-oriented  
Priority/cycle time assignment of messages via master configuration
- Physical Bus: RS 485 according to [TIA/EIA-485-A](#)  
Max. nodes: 127



### 7.8.2.1 Technical data for the Profibus-DP interface

<b>EMC protection requirements</b>	Immunity to interference as per EN 61000-6-2 (evaluation criterion A) Emitted interference as per EN 61000-6-4
<b>Connectors X3 and X4</b>	In each case a 4-pin plug connector with socket connectors (eXLink plug connector Fa. CEAG, coding 5h) ⇒ Chap. "7.8.2.2 Pin assignment, Profibus-DP connectors", page 87
<b>Physical</b>	Conformity as per test specification "PROFIBUS slaves Version 2.0 of the PNO, Order-No: 2.032"
<b>Maximum voltage capacity</b>	-9 V to 14 V (long-term) from signal cable to Profi GND ±500 V long-term referenced to supply zero (optical isolation) ±40 V with a pulse of 15 µs via a resistance of 100 Ω with an edge duration < 100 ns.
<b>Maximum permissible number of Profibus-DP nodes</b>	32 bus nodes without repeater With repeater up to 126 nodes

#### Technical data for the Profibus-DP interface

Tab. 10: Technical data for the Profibus-DP interface

### 7.8.2.2 Pin assignment, Profibus-DP connectors

#### Profibus DP connectors X3 and X4

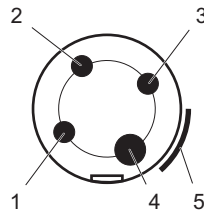

View of the Profibus-DP female receptacle X3 and X4  
on the valve (external thread, socket contacts)

Contact	Assignment	Description
1	Profi V+	Terminal resistors for RXD/TXD-P
2	Profi A	RXD/TXD-N
3	Profi GND	Terminal resistors for RXD/TXD-N
4	Profi B	RXD/TXD-P
5	Shield	Positioned on control cabinet side

Fig. 38: Profibus DP connectors X3 and X4

#### CAUTION

#### Danger of property damage due to improper plug connection!

In order to avoid damage to the explosion proof connector:

- ▶ Heed the notes and instructions in the "Ex connector eXLink" operating instructions.

### 7.8.3 EtherCAT connectors

The EtherCAT bus has the following features:

- Standardized in accordance with [IEC 62407](#)
- Single-master system:  
The master initiates communication.  
Slaves react only on request.
- Topology:  
Line, star, tree and ring structure based on the daisy chain principle
- Network expansion and transmission rates:  
100 m between two nodes at 100 Mbit/s
- Addressing type: Address-orientated, one telegram for all nodes
- Physical Bus: Fast Ethernet  
Max. nodes: 65,535

### 7.8.3.1 Technical data for the EtherCAT interface

<b>EMC protection requirements</b>	Immunity to interference as per <a href="#">EN 61000-6-2</a> (evaluation criterion A) Emitted interference as per <a href="#">EN 61000-6-4</a>
<b>Connectors X3 and X4</b>	In each case a 4-pin plug connector with socket connectors (eXLink plug connector Fa. CEAG, coding 5h) ⇒ <a href="#">Chap. "7.8.3.2 Pin assignment, EtherCAT connectors", page 89</a>
<b>Physical</b>	4-core, paired cable as per CAT 5 for 100-Base-TX transmission Network topology: Tree and line Termination: device-internal Transmission rate: 100 Mbit/s As per <a href="#">EN 61158-2</a> Type 12 EtherCAT, "PHYSICAL LAYER SPECIFICATION AND SERVICE DEFINITION" and <a href="#">ISO/IEC 8802-3</a> 100 Base-TX ( <a href="#">IEEE 802.3</a> Section 24)
<b>Maximum voltage capacity</b>	±500 V long-term referenced to supply zero (optical isolation)
<b>Maximum permissible number of EtherCAT bus nodes</b>	65.536 The maximum number of nodes in a field bus line is 216.

#### Technical data for the EtherCAT interface

Tab. 11: Technical data for the EtherCAT interface

### 7.8.3.2 Pin assignment, EtherCAT connectors

#### EtherCAT connectors X3 and X4

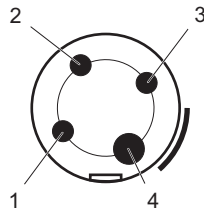

View of the EtherCAT female receptacle X3 and X4 on the valve (external thread, socket contacts)

Contact	Assignment	Description
1	TX+	Transmit
2	RX+	Receive
3	TX-	Transmit
4	RX-	Receive

Fig. 39: EtherCAT connectors X3 and X4

#### CAUTION

**Danger of property damage due to improper plug connection!**

In order to avoid damage to the explosion proof connector:

- ▶ Heed the notes and instructions in the "Ex connector eXLink" operating instructions.

To connect the valves to an EtherCAT network, we recommend molded cord sets with an integral straight mating connector.

⇒ [Chap. "7.18 Wiring EtherCAT networks \(X3, X4\)", page 121](#)

## 7.9 Analog input connectors X5, X6 and X7

The analog inputs of connectors X5, X6 and X7 have a resolution of 14 bits.

### 7.9.1 Pin assignment, analog input connectors X5, X6 and X7

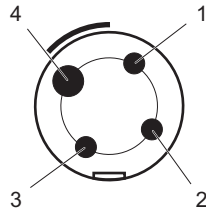

View of the analog input female receptacle X5, X6 and X7 on the valve  
(external thread, socket contacts)

Analog input  
connectors X5, X6 and X7

Contact	Assignment	Description
1	Transducer supply	+24 V, $I_{\max} (X2+X5+X6+X7) = 300$ mA referenced to pin 3
2	Reference point of analog input	Reference point for pin 4
3	Transducer supply 0 V	Supply zero
4	Analog input	Current or voltage input referenced to pin 2

Fig. 40: Analog input connectors X5, X6 and X7

⇒ [Chap. "7.19 Wiring analog inputs \(X5, X6, X7\)", page 124](#)

#### Power supply to the transducer

The transducer is supplied with power via pin 1 of connectors X5, X6 and X7.

⇒ [Fig. 40, page 90](#)



There is joint fusing of this power supply for X2, X5, X6 and X7. The total supply current must therefore not exceed the following value:

$$I_{\max} (X2+X5+X6+X7) = 300 \text{ mA}$$

An external power supply to the transducer is also possible. However, the 0 V transducer supply must be connected to supply zero. An interruption of the transducer supply current can be identified as a cable break (see "Firmware" User Manual).

The supply voltage is cut off in the event of a possible short circuit in the supply voltage to the transducer. A fault reaction can be configured (see "Firmware" User Manual). The voltage is available again as soon as the short circuit has been eliminated.

Power supply to  
the transducer at  
connectors X5, X6, X7

## 7.9.2 Signal types

The analog inputs are available in the following versions:

- $\pm 10$  V
- 0–10 V
- 0–10 mA
- 4–20 mA

**Signal types of the analog inputs at connectors X5, X6, X7**

The inputs can be operated in each case differentially or single-ended (one input cable referenced to supply zero).

Which signal type is set for the analog inputs on delivery depends on the valve model. The signal types can be configured via the firmware.



Detailed information can be found in the "Firmware" User Manual.

### Signal type for the analog input: $\pm 10$ V

In the case of this signal type, the input is configured as either a differential or a single-ended voltage input with a  $\pm 10$  V input range.

⇒ [Chap. "7.9.3 Input resistances", page 92](#)

**Analog input:  $\pm 10$**

The potential difference of each input to supply zero must be between -15 V and 32 V.

If there is no differential analog source available, the reference point of the analog input (pin 2) must be connected to 0 V of the analog source.

### Signal type for the analog input: 0–10 V

For this signal type, the input is either configured as a differential or as a single-ended voltage input with 0–10 V input range.

⇒ [Chap. "7.9.3 Input resistances", page 92](#)

**Analog input: 0–10 V**

The potential difference of each input to supply zero must be between -15 V and 32 V.

If there is no differential analog source available, the reference point of the analog input (pin 2) must be connected to 0 V of the analog source.

### Signal type for the analog input: 0–10 mA

In the case of this signal type, the input is configured as either a differential or a single-ended current input with a 0–10 mA input range.

⇒ [Chap. "7.9.3 Input resistances", page 92](#)

**Analog input: 0–10 mA**

The analog input is deactivated in the event of an excessively high input current.

The potential difference of each input to supply zero must be between -15 V and 32 V.

If there is no floating analog source available, the reference point of the analog input (pin 2) must be connected to 0 V of the analog source.

### Signal type for the analog input: 4–20 mA

In the case of this signal type, the input is configured as either a differential or a single-ended current input with a 4–20 mA input range.

⇒ Chap. "7.9.3 Input resistances", page 92

The analog input is deactivated in the event of an excessively high input current.

The potential difference of each input to supply zero must be between -15 V and 32 V.

If there is no floating analog source available, the reference point of the analog input (pin 2) must be connected to 0 V of the analog source.

In the 4–20 mA signal range signals of  $I_{in} < 3$  mA (e.g. due to a defective electric cable) signify a fault, which can be evaluated by the valve software. The monitoring must be activated in the valve software.

### Analog input: 4–20 mA

## 7.9.3 Input resistances

The input resistances of the analog inputs are dependent on the set signal type and the version.

### Input resistances

Signal type	Version	$R_D$	$R_1$	$R_2$
Voltage $\pm 10$ V; 0–10 V	Differential	200 k $\Omega$	250 k $\Omega$	10 k $\Omega$
	Single-ended	200 k $\Omega$	250 k $\Omega$	< 5 $\Omega$
Current 0–10 mA; 4–20 mA	Differential	210 $\Omega$	100 k $\Omega$	10 k $\Omega$
	Single-ended	210 $\Omega$	100 k $\Omega$	< 5 $\Omega$

Tab. 12: Input resistances X5, X6, X7

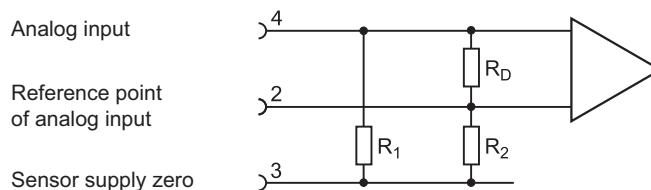
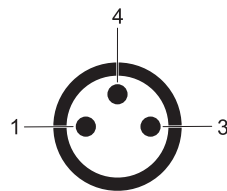

Fig. 41: Equivalent circuit diagram of analog input

## 7.10 Service connector X10

This interface serves to connect diagnostic and start-up tools and is available on connector X10.

**Service connector X10**



View of service connector X10  
(external thread, pin contacts)

**Service connector X10  
(M8, 3-pin)**

Contact	Assignment	Description
1	CAN_H	Transceiver H
3		Not assigned
4	CAN_L	Transceiver L

Fig. 42: Service connector X10 (M8, 3-pin)

Valves without CAN bus interfaces can be started up and configured via the service interface (service connector X10) with the Moog Valve and Pump Configuration Software.

### WARNING



#### Danger of explosion!

To guarantee safe operation in hazardous area.

- ▶ In the standard model with a screw plug, the service connector X10 is not permitted for use in hazardous area.
- ▶ When mounting the screw plug of the service connector X10, it must be observed that the gasket and the thread of the screw plug as well as the thread in the electronic housing of the valve are not damaged.
- ▶ In case of damage to the screw plug for the service connector or the threads in the electronic housing, the valve must not be operated in an hazardous area.
- ▶ Tightening torque for screw plug:  
⇒ [Chap. "3.1.2 Representative depiction of the valve", page 18](#)



**DANGER****Danger of explosion!**

An explosion can be triggered by sparks when switching on the machine.

- ▶ Open connectors for the interface must absolutely be covered before start-up.
- ▶ The eXLink connectors from CEAG must be mounted according to the instructions in the operating instructions for the eXLink connector.
- ▶ In its standard model with screw plug, the service connector X10 is not permitted for use in hazardous area.
- ▶ The service connector X10 in the standard model M8, 3-pin must be sealed with the original screw plug belonging to the valve before start-up.
- ▶ For mounting of the screw plug of the service connector X10, it must be observed that the gasket and the threads of the screw plug as well as the threads in the electronic housing of the valve are not damaged.
- ▶ In case of damage to the screw plug of the service connector X10 or the threads in the electronic housing, the valve must not be operated.
- ▶ Tightening torque screw plug:  
⇒ [Chap. "3.1.2 Representative depiction of the valve", page 18](#)



For the standard model of the valve, the service interface is not suitable for use in hazardous area. On request, the service interface is available in an explosion-proof model.

## 7.11 General notes on wiring

### DANGER



#### **Danger of explosion!**

An explosion can be triggered by sparks when switching on the machine.

- ▶ Open connectors for the interface must absolutely be covered before start-up.
- ▶ The eXLink connectors from CEAG must be mounted according to the instructions in the operating instructions for the eXLink connector.
- ▶ In its standard model with screw plug, the service connector X10 is not permitted for use in hazardous area.
- ▶ The service connector X10 in the standard model M8, 3-pin must be sealed with the original screw plug belonging to the valve before start-up.
- ▶ For mounting of the screw plug of the service connector X10, it must be observed that the gasket and the threads of the screw plug as well as the threads in the electronic housing of the valve are not damaged.
- ▶ In case of damage to the screw plug of the service connector X10 or the threads in the electronic housing, the valve must not be operated.
- ▶ Tightening torque screw plug:  
⇒ [Chap. "3.1.2 Representative depiction of the valve", page 18](#)

### 7.11.1 Tools and materials required

### WARNING



#### **Danger of explosion**

To guarantee safe operation in hazardous area:

- ▶ The signal interfaces of the valve are implemented with explosion-proof connectors.
- ▶ For mounting and removal of the connectors as well as operation of the valve, the notes and instructions in the "Explosion-proof connectors eXLink, CEAG" operating instructions must absolutely be adhered to.

### CAUTION

#### **Danger of property damage due to improper plug connection!**

In order to avoid damage to the explosion proof connector:

- ▶ Heed the notes and instructions in the "Ex connector eXLink" operating instructions.

The following are required for electrically connecting the valves:

- Mating connector for connector X1 (7-pin)
- Connection cables for mating connector
- Crimping tool for mating connector with corresponding crimping insert
- Installation tool

**Tool required**

The above-mentioned connectors, cables and tools are not included in the valve scope of delivery. They are supplied separately.

⇒ Chap. "12.1 Accessories", page 173

## 7.11.2 Procedure

Procedure for electrically connecting the valve:

**Procedure for electrical connection**

1. Conduct electrical connection in accordance with the pin assignment.  
⇒ Chap. "7.4 Connector X1", page 76
2. Establish equipotential bonding, protective grounding and electrical shielding.  
⇒ Chap. "7.12 Protective grounding and electrical shielding", page 97  
⇒ Chap. "7.13 Permissible lengths for connection cables", page 105
3. Valves with field bus interface: wire field bus.  
⇒ Chap. "7.16 Wiring CAN networks", page 113  
⇒ Chap. "7.17 Wiring Profibus-DP networks (X3, X4)", page 118
4. Check whether all the connectors and if necessary the service connector to which no mating connector is attached are covered with a suitable dust protection cap.
5. If necessary, put a dust protection cap on.



Make sure to heed the instructions and notes in the eXLink plug connector operating instructions from CEAG.

## 7.11.3 Wiring supply cables and digital and analog signals

Activation of the analog inputs with differential signals is to be preferred. If the signal cannot be transmitted differentially, the reference point of the input at the valve must be connected to ground (supply zero).

⇒ Chap. "7.14.1 Single-ended command signals", page 110

Because current inputs have a lower input resistance than voltage inputs and are thus immune to interference, activation with a current signal is to be preferred to activation with a voltage signal.

**Evaluating the different signal types**

Signal type	Benefits
±10 V or 0–10 V	Simple measurement of the signal, e.g. with an oscilloscope.
±10 mA or 0–10 mA	Large transmission lengths are possible.
4–20 mA	Detection of faults in the electrical line and large transmission lengths are possible.

**Benefits of the different signal types for analog inputs**

Tab. 13: Benefits of the different signal types for analog inputs

## 7.12 Protective grounding and electrical shielding

### 7.12.1 Overview

The valves with integrated electronics are equipped with a protective conductor connection (⊕) in the connector or on the valve body in accordance with the requirements of the standard [EN 60204](#).

This chapter contains guidelines on protective grounding and electrical shielding of cables in applications in which the valves with integrated electronics are used.

#### Guidelines for protective grounding

#### CAUTION



##### **Danger of personal injury and damage to property!**

Improper grounding and shielding can cause damage, malfunctions or failures of valves or the machine.

- ▶ The valves should only be used in such machines and plants that comply with the requirements of the standard [EN 60204-1](#) and this chapter.

#### CAUTION

##### **Risk of personal injury due to insufficient electrical safety!**

Compliance with the safety regulations requires that the equipment be isolated from the mains system in accordance with [EN 61558-1](#) and [EN 61558-2-6](#) and that all voltages be limited in accordance with [EN 60204-1](#).

- ▶ Only use SELV/PELV power supplies!

## 7.12.2 Equipotential bonding and protective grounding

- The purpose of equipotential bonding is to establish as small a potential difference as possible within the machine.
- Protective grounding serves to maintain safety while the machine is in operation.
- The term protective earth or PE designates only a single point within the machine: the connection point of the external protective conductor. All additional connections to ground ( $\oplus$ ) are established via protective and equipotential bonding conductors.

### Equipotential bonding and protective grounding of machines

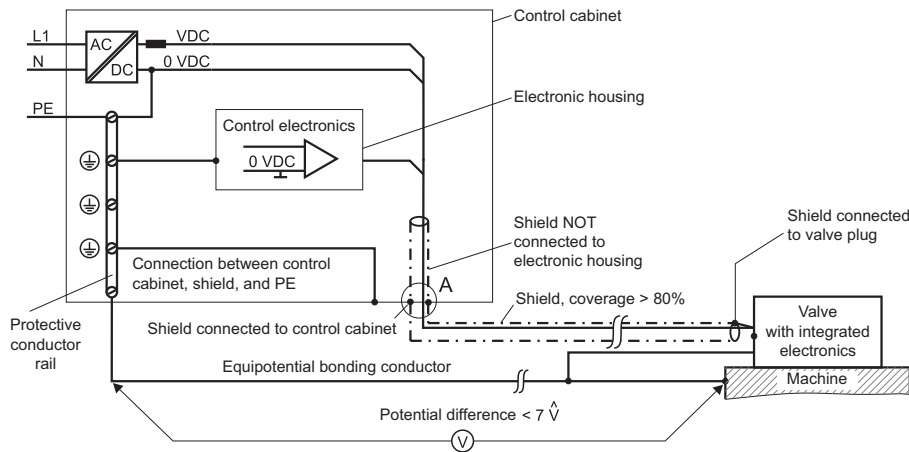

Fig. 43: Equipotential bonding and protective grounding of machines (see also EN 60204-1) and electrical shielding of our valves with integrated electronics

### 7.12.2.1 General principles

#### DANGER



#### Danger of explosion in case of unsafe operation!

In order to create as small a potential difference in the machine and to guarantee safe operation of the machine, the equipotential bonding and protective conducting system for a machine in which the valves should be used must be constructed according to [EN 60204-1](#).

- ▶ Connect all elements of the machine to each other via equipotential bonding conductors.
- ▶ Connect all elements of the machine that have exposed metal surfaces via protective conductors to the protective conductor rail.
- ▶ Connect all the protective conductors and the equipotential bonding conductor in the main cabinet via the protective conductor rail to the protective earth (PE) terminal.

Observe the following points when performing equipotential bonding and protective grounding:

- Connect all elements of the machine to each other via equipotential bonding conductors.
- Connect all elements of the machine that have exposed metal surfaces via protective conductors to the protective conductor rail.
- Connect all the protective conductors and the equipotential bonding conductor in the main cabinet via the protective conductor rail to the protective earth (PE) terminal.

#### Performing equipotential bonding



The cross section of the protective conductor is specified in [EN 60204-1](#), Section 8. The following cross section have proven successful for equipotential bonding conductors:

- up to 200 m cable length: 16 mm<sup>2</sup>
- up to 200 m cable length: 25 mm<sup>2</sup>

#### Required cross section of the protective conductor



The potential difference between any two points within the machine should not be more than 7 V peak ( $7 \hat{V}$ ).

- Connect the electrical shielding and the electrical ground of the electronics chassis point-to-point to the protective conductor rail.
- Before releasing a machine for normal operation, always check that all equipotential bonding and protective conductors are in proper working order in accordance with [EN 60204-1](#), Section 18.

#### Maximum potential difference

### 7.12.2.2 Protective conductor

The valves must essentially only be operated with safe power supplies (SELV/PELV). No dangerous voltages are generated in the valve. Therefore, no protective conductor must be connected.

#### Requirements of the protective conductor

#### DANGER



#### Danger to life!

People can be injured and property damaged through the operation of the valve with an unsafe power supply.

- ▶ Only use SELV/PELV power supplies as per EN 60204-1!

### 7.12.2.3 Ground loops

If a valve is connected to protective earth (PE) both via the equipotential bonding system and via the valve protective conductor, a compensating current can split in the resulting ground loop. This current can cause serious malfunctions in the machine.

#### Avoiding ground loops

Observe the following points in order to minimize as much as possible malfunctions caused by a ground loop:

- Route the valve supply and signal cables as closely as possible to the equipotential bonding conductor.  
⇒ [Chap. "7.12.3 Machines with deficient equipotential bonding", page 101](#)
- The impedance of the equipotential bonding system should be less than 10 % of the impedance of the systems comprising cable protective conductors and shields.

## 7.12.3 Machines with deficient equipotential bonding

### DANGER



#### Danger to life due to electric shock!

Very strong current can flow via the shield connection of the valve.

- ▶ Extreme caution is required since for some industrial applications, no good equipotential bonding can be implemented.
- ▶ An effective equipotential bonding system must be set up in compliance with EN 60204-1, Section 8.

### Deficient equipotential bonding

## 7.12.4 Electrical shielding

An effectively shielded machine is to a high degree immune to external interference sources. Furthermore, the interference emitted by the machine is reduced considerably by effective shielding.

### Electrical shielding

A functioning equipotential bonding system provides the basis for an effectively shielded machine. To ensure that the cables are effectively shielded, it is essential to satisfy the general requirements with regard to equipotential bonding and protective grounding.

⇒ Chap. "7.12.2 Equipotential bonding and protective grounding", page 98

### 7.12.4.1 Cables

Observe the following points when choosing cables for connecting the valves:

### Requirements of cables

- Only use shielded cables.
- The cable shield should be made of copper braiding with a minimum 80 % coverage.
- The individual conductors must be made of copper and have a minimum cross section of 0.2 mm<sup>2</sup> in accordance with EN 60204-1.
- Use cables with twisted pair conductors in environments with high background noise levels.
- The protective conductor should be guided within the cable shield.  
⇒ Chap. "7.12.2.2 Protective conductor", page 100



### 7.12.4.2 Connecting the shield



When connecting the shield, use metal shell connectors with a leading protective earth contact (⊕) in accordance with EN 60204-1.

#### Connection on the valve side

Connect the cable shield conductively to the metal shell of the connector.

#### Connecting the shield on the valve side

#### Connection on control cabinet side

Connection on the control cabinet side can be completed with either lead-through cables or connectors.

#### Connecting the shield on the control cabinet side

#### Cable leadthrough

Observe the following points when connecting the shield on the control cabinet side:

#### Connecting the shield with cable leadthrough

- Connect the control cabinet's wall conductively to the protective conductor rail (⊕).  
⇒ Fig. 43, page 98
- Connect the cable shield correctly (flat, conductively) to the control cabinet's wall.

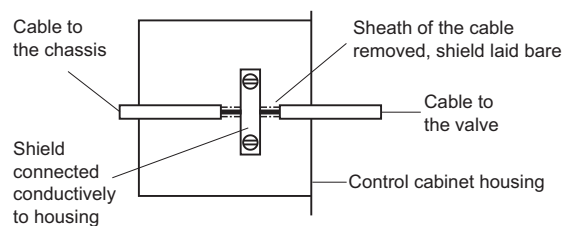

Fig. 44: Connecting the shield to the control cabinet's wall (detail A from fig. 43)

### WARNING



#### Danger due to electric shock!

The shield of the cable must be laid correctly in order to prevent faults in the machine and injuries to people.

- ▶ Do NOT connect the shield of the cable with the electronics chassis.

- Lead the cable shield without interruption through the wall of the EMC-compliant control cabinet as closely as possible to the electronics chassis, e.g. by means of a cable gland.

## Plug connection

Observe the following points when connecting the shield on the control cabinet side:

### Connecting the shield with plug connection

- Connect the control cabinet's wall conductively to the protective conductor rail (⊕).  
⇒ Fig. 43, page 98
- Connect the shield of the cable coming from the valve to the housing of the removable connector.



The housing of the connector permanently mounted in the control cabinet must demonstrate a good-conducting connection with the wall of the control cabinet.

- Connect the connector mounted in the wall of the control cabinet to the shield inside the cabinet.

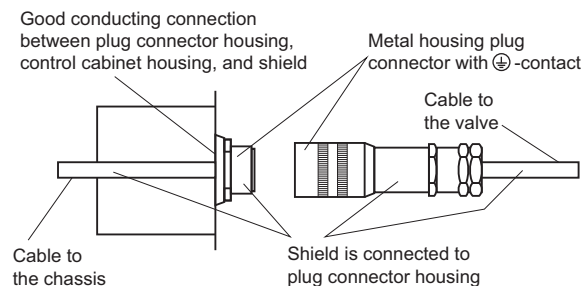

Fig. 45: Connecting the cable shield via connector to the control cabinet's wall (detail A from fig. 43)

- Lead the shield inside the control cabinet as closely as possible to the electronics chassis.

## WARNING



### Danger due to electric shock!

The shield of the cable must be laid correctly in order to prevent faults in the machine and injuries to people.

- ▶ Do NOT connect the shield of the cable with the electronics chassis.

### 7.12.4.3 Insulated shielding

If connecting the shield to both ends of the cable is not desirable, such as in a machine with deficient equipotential bonding, insulated shielding may be required. However, this is normally only necessary if it is not possible to establish a good equipotential bonding system.

#### Insulated shielding in the event of deficient equipotential bonding

Observe the following points when connecting insulated shielding:

- Use metal shell connectors with a leading protective earth contact (⊕) in accordance with EN 60204-1.
- Connect the cable shield conductively to the metal shell of the connector.
- Connect the control cabinet's wall conductively to the protective conductor rail (⊕).  
⇒ Fig. 43, page 98
- Connect the cable shield via a capacitor (e.g. 10 nF / 100 VDC ceramic capacitor) to the control cabinet's wall.

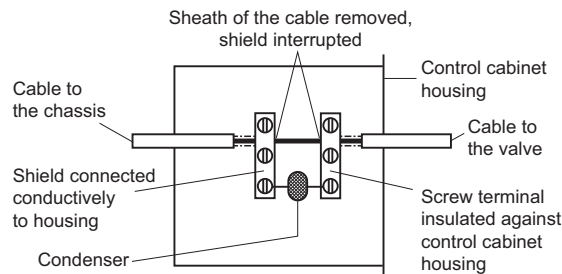

Fig. 46: Connecting the insulated shielding to the control cabinet's wall (detail A from fig. 43)

- Install a separate shield connected to the control cabinet's wall inside the control cabinet. Route this shield as closely as possible to the electronics chassis.

#### WARNING



#### Danger due to electric shock!

The shield of the cable must be laid correctly in order to prevent faults in the machine and injuries to people.

- ▶ Do NOT connect the shield of the cable with the electronics chassis.

### 7.12.4.4 Cable routing

The routing of the cable inside a machine must comply with the following general guidelines:

- Route supply and signal cables in separate cable conduits.
- In order to minimize malfunctions caused by a ground loop, route the valve connection cables as closely as possible to the equipotential bonding conductor.  
⇒ [Chap. "7.12.2.3 Ground loops", page 100](#)
- Do not route cable conduits near strong electromagnetic interference sources, such as electric motors or transformers.
- If the cable routing cannot eliminate the risk of lightning strokes completely, suitable protective measures must be taken, as described in [EN 60204-1](#).

#### Cable routing inside the machine

## 7.13 Permissible lengths for connection cables

### 7.13.1 Introduction

The valves with integrated electronics are supplied via 24 V supply cables and controlled via analog or field bus cables.

This section of the chapter is intended to serve as a guide to dimensioning and configuring supply and signal cables in order to guarantee adequate supply voltage and signal quality for all the permissible valve operating states.

The maximum permissible length of supply and signal cables is limited by the resistance and the capacitance per unit length of the cables.

#### Dimensioning of supply and signal cables

### 7.13.2 Typical values for copper cables

The typical values specified here are used in the example calculations in the following sections.

#### 7.13.2.1 Resistance of cable

The typical resistance  $R_{\text{typ}}$  of a copper cable of length  $\ell$  is calculated as follows:

$$R_{\text{typ}} = \frac{\rho_{\text{Cu}}}{q_{\text{typ}}} \cdot \ell = 23.73 \frac{\text{m}\Omega}{\text{m}} \cdot \ell$$

$$q_{\text{typ}} = 0.25 \text{ mm}^2 \quad \text{Typical cross section used for connection cables}$$

$$\rho_{\text{Cu}} = 0.0178 \frac{\Omega\text{mm}^2}{\text{m}} \quad \text{Resistivity of copper at } 20 \text{ }^\circ\text{C}$$

#### Calculating the resistance

#### 7.13.2.2 Capacitance of cable

The typical capacitance per unit length of copper cables is 50 pF/m.

The typical capacitance  $C_{\text{typ}}$  of a copper cable of length  $\ell$  is calculated as follows:

$$C_{\text{typ}} = 50 \frac{\text{pF}}{\text{m}} \cdot \ell$$

#### Calculating the capacitance

### 7.13.3 24V supply cables

The maximum permissible length  $\ell_{\max}$  of the supply cable is calculated as follows:

**Calculating the maximum length of supply cables**

$$I_{\max} = \frac{U_{\text{dr\_max}}}{\left(\frac{U_{\text{ab}}}{I}\right)_{\text{typ}}}$$

$$U_{\text{dr\_max}} = I_{\max} \cdot \left(\frac{U_{\text{ab}}}{I}\right)_{\text{typ}}$$

$U_{\min} = 18 \text{ V}$       Lowest permissible supply voltage for valve

$U_{\text{dr\_max}} = 6 \text{ V}$       Maximum permissible voltage drop over the supply cable  
 $U_{\text{dr\_max}} = 24 \text{ V} - U_{\min}$

$\left(\frac{U_{\text{ab}}}{I}\right)_{\text{typ}}$       voltage drop per unit length  
 ⇒ [Chap. "7.13.3.1 Voltage drop per unit length", page 107](#)



This calculation does not take into account a possible reduction of the power supply output voltage on account of the connected load. Nor does it take into account any voltage dips that can occur at the moment when additional loads are connected.

### 7.13.3.1 Voltage drop per unit length

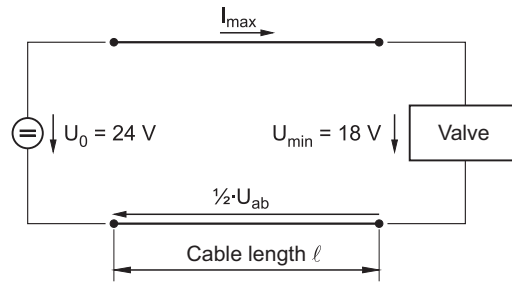

Fig. 47: Voltage drop on the supply cable

The voltage drop per unit length over the forward and return lines of the supply cable is calculated as follows:

$$\left(\frac{U_{ab}}{l}\right)_{\text{typ}} = 2 \cdot I_{\max} \cdot \left(\frac{R_{\text{typ}}}{l}\right) = 2 \cdot I_{\max} \cdot 23.73 \frac{\text{m}\Omega}{\text{m}}$$

$I_{\max}$  Maximum current consumption of valve  
(see product-specific valve user manual)

$R_{\text{typ}}$  Typical resistance of the cable  
⇒ [Chap. "7.13.2.1 Resistance of cable", page 105](#)

$\ell$  Length of the supply cable

### 7.13.3.2 Examples of the voltage drop of supply cables

Valve series	Max. current consumption $I_{\max}$	Voltage drop $\left(\frac{U_{ab}}{l}\right)_{\text{typ}}$	Max. permissible cable length $\ell_{\max}$
D637K/D639K	2,200 mA	104 mV/m	58 m

Examples of the voltage drop of supply cables

Tab. 14: Examples of the voltage drop of supply cables as a function of the cable length for a cable cross section of  $0.75\text{ mm}^2$

## 7.13.4 Analog signal cables

### Influence of resistance R

The influence of the resistance R of the cable used on the maximum cable length  $\ell_{\max}$  for signal cables is very low, as the currents flowing through signal cables are very small.

#### Example:

For a cable length  $\ell$  of 428 m the resistance R according to the formula below is only 10  $\Omega$ .

$$R = \frac{\rho_{\text{Cu}}}{q_{\text{typ}}} \cdot l = 23.73 \frac{\text{m}\Omega}{\text{m}} \cdot 428 \text{ m} \approx 10 \Omega$$

### Influence of capacitance per unit length

The influence of the capacitance per unit length of the cable used on the maximum cable length  $\ell_{\max}$  for signal cables is considerably greater.

The capacitance C that increases with the cable length forms with the input resistance R of an analog input a high pass of the first order, which can couple high-frequency interference for example at signal inputs. The limit frequency  $f_l$  of the high pass is calculated as follows:

$$f_g = \frac{1}{2 \cdot \pi \cdot R \cdot C}$$

The longer the cable, the lower the limit frequency  $f_l$  of the high pass.

#### Example:

A cable length  $\ell$  of 10 m and a typical analog input resistance R of 10 k $\Omega$  produce according to the formula below a limit frequency  $f_l$  of 32 kHz.

$$f_g = \frac{1}{2 \cdot \pi \cdot R \cdot C} = \frac{1}{2 \cdot \pi \cdot R \cdot 50 \frac{\text{pF}}{\text{m}} \cdot l}$$

$$f_g = \frac{1}{2 \cdot \pi \cdot 10 \text{ k}\Omega \cdot 50 \frac{\text{pF}}{\text{m}} \cdot 10 \text{ m}}$$

$$f_g = 32 \text{ kHz}$$

### Recommendations

With a differential voltage command signal and a cable length  $\ell$  of 10 m the EMC test was conducted in accordance with EN 61000-6-2. The interference on the spool position during the interference (electromagnetic coupling, transient) was below 1 %. This can worsen as the cable is lengthened.

Experience shows that with cable lengths over 15 m a current input should be used, as here the input resistance is smaller by a factor of 50.

The limit frequency  $f_l$  of the high pass also increases by the same factor, and with it the input becomes more immune to interference.

Furthermore, the voltage drop on the cable does not have an effect in the event of a current command signal.

A differential input is always to be recommended, regardless of whether a voltage or current signal is used as the command signal, since interference coupled on the two input cables is subtracted to virtually zero.

### Influence of resistance R

### Influence of capacitance per unit length

### Calculating the limit frequency

### Current input with cable length > 15 m

### Recommendation: differential input

## 7.13.5 Digital signal cables

### 7.13.5.1 Digital signal input cables

Digital signal input cables, such as enable, are more non-critical with regard to their cable lengths, because the currents are low (< 20 mA) and a greater noise level distance is easier to maintain, since only two states/levels must be differentiated.

**Length of digital  
signal cables**

### 7.13.5.2 Digital signal output cables

With digital signal output cables, such as monitoring and standby, currents up to 1.5 A are encountered. In these cases, the voltage drop over longer cables can no longer be neglected. Thus, these cables are subject to the same requirements as supply cables.

⇒ [Chap. "7.13 Permissible lengths for connection cables", page 105](#)

### 7.13.5.3 Field bus cables

In the case of digital field bus cables, the maximum possible cable lengths are very different. For the most part the cable ends are terminated with low resistance (power adaptation) in order to avoid signal reflections, which permits longer cable lengths. The maximum possible cable lengths are laid down in the standards of the relevant field buses and depend among other things on the transmission rate used.

**Length of field bus cables**



## 7.14 Wiring connector X1

### Wiring of the 7-pin connector X1

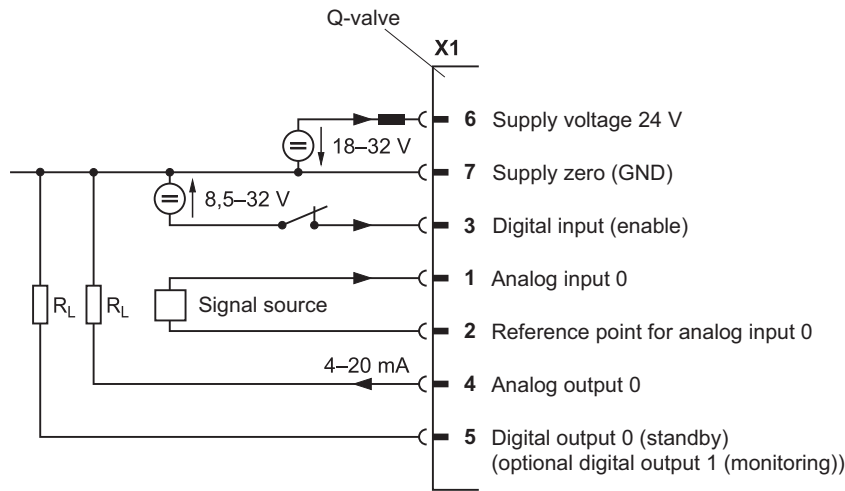

Fig. 48: Wiring of the 7-pin connector X1 Q valve

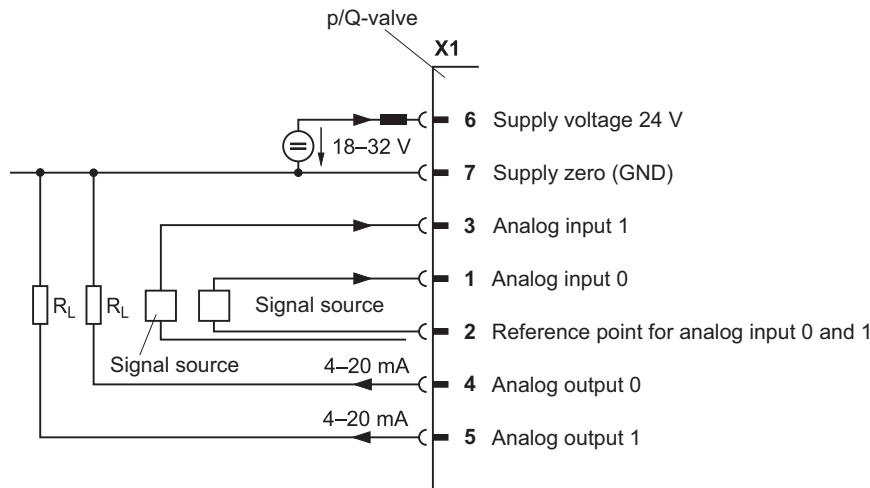

Fig. 49: Wiring of the 7-pin connector X1 pQ valve

### 7.14.1 Single-ended command signals

Activation of the command inputs with differential signals is to be preferred. If the command signal cannot be transmitted differentially, the reference point of the command input at the valve must be connected to ground (GND).

### Circuit for single-ended command signals

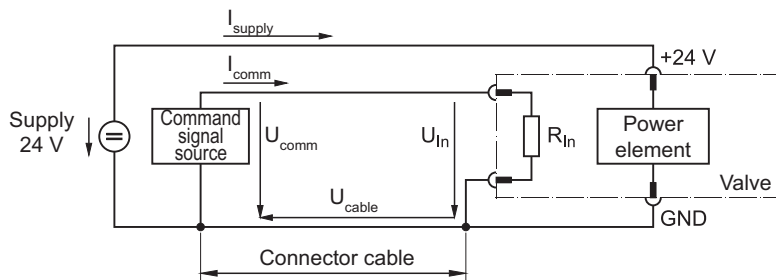

Fig. 50: Circuit for single-ended command signals

If the command inputs are connected to ground (single-ended), the connection cable must be as short as possible and have an appropriately large cross section in order to keep the voltage drop as low as possible.

The voltage drop on the forward and return lines is generated by the supply current  $I_{\text{Supply}}$  of the valve electronics power circuit. It is proportional to the length of the connection cable and varies according to the valve status.

Maximum permissible cable lengths:

⇒ Chap. "7.13 Permissible lengths for connection cables", page 105

The voltage drop  $U_{\text{cable}}$  on the return line and the resulting potential shift of ground (supply zero) results in not the command signal  $U_{\text{comm}}$  but rather the input voltage  $U_{\text{in}}$  being applied at the command input in accordance with the following equation:

$$U_{\text{in}} = U_{\text{comm}} - U_{\text{cable}}$$

In the case of command signal sources with impressed current  $I_{\text{comm}}$ , the potential shift of ground (supply zero) has no effect on the signal. However, changes in the voltage drop resulting from the valve's varying current consumption must be corrected by the command signal source. If current control does not follow the voltage change in terms of time, the command signal at the valve input may also be affected here.



The function of single-ended command inputs is identical to the function of differential command inputs.

**Single-ended connection of the command inputs**

**Input voltage  $U_{\text{in}} = U_{\text{comm}} - U_{\text{cable}}$**

**Command signal sources with impressed current  $I_{\text{comm}}$**

## 7.14.2 Conversion of actual value output signals $I_{\text{out}}$

The actual value output signals  $I_{\text{out}}$  4–20 mA can be converted into  $U_{\text{out}}$  2–10 V in accordance with the following circuit.

**Conversion of actual value output signals  $I_{\text{out}}$  4–20 mA into 2–10 V**

### 7.14.2.1 Valves with 7-pin connector X1

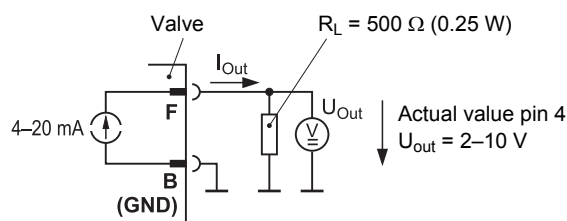

Fig. 51: Circuit for converting the actual value output signals  $I_{\text{out}}$  (for valves with 7-pin connector X1)

## 7.15 Wiring SSI transducers (X2)

An SSI transducer delivers an absolute position or angle signal, which can be read in via the digital signal interface.

### Wiring SSI transducers (X2)

### 7.15.1 SSI master mode

In SSI master mode the integrated electronics generate internally the SSI clock signal (CLK) with settable frequencies in the range between 78 kHz and 5 MHz.



Detailed information can be found in the "Firmware" User Manual.

In the rest state the clock signal is at 1. The first falling edge of the clock signal signals to the SSI transducer to maintain its current value. The following rising edge of the clock signal starts the data transmission of the SSI transducer. The output starts with the highest-value bit (MSB). After a complete data record has been transmitted, the SSI transducer holds the data signal at 0 until it is ready for a new transmission. The switching back of the data signal to 1 simultaneously satisfies the start condition for the SSI interface for triggering a new read-in cycle.

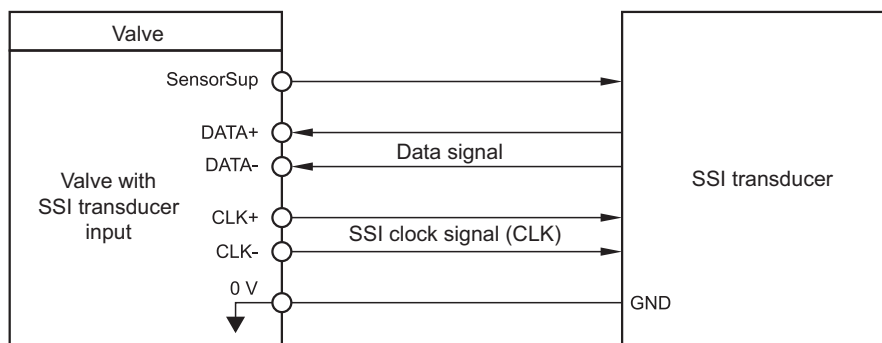

Wiring diagram with SSI transducer

Fig. 52: Wiring diagram with SSI transducer

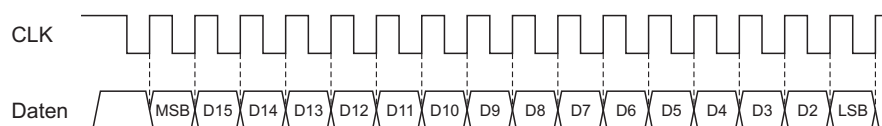

Signals between valve and a 16-bit SSI transducer (example)

Fig. 53: Signals between valve and a 16-bit SSI transducer (example)

The signal levels conform to the standard [EIA 422](#).

SSI transducers can be used with either Gray codes or binary coded data. A maximum of 32 bits is possible.



Detailed information can be found in the "Firmware" User Manual.

## 7.16 Wiring CAN networks

The valves are equipped with an electrically isolated CAN interface depending on the model. The CAN interface is supplied internally.

### Procedure for connecting the valve to the CAN bus

### Procedure

#### CAUTION

##### **Danger of personal injury and damage to property!**

Failure to heed safety instructions causes malfunctions and thus corresponding risks to people and equipment.

- ▶ Please heed all the safety instructions prior to and during start-up.

1. Establish the electrical connection to the CAN bus.  
⇒ [Chap. "7.8.1 CAN connectors", page 84](#)
2. Set the module address.  
⇒ [Chap. "7.16.3 CAN module address \(node ID\)", page 117](#)
3. Set the transmission rate.  
⇒ [Chap. "7.16.4 CAN transmission rate", page 117](#)
4. Check the configuration of the valve software and the controller settings.

#### Observe the following points when wiring CAN networks:

- All cables, connectors and terminal resistors used in CAN networks should comply with [ISO 11898](#).
- Correct version of protective grounding and electrical shielding.  
⇒ [Chap. "7.12 Protective grounding and electrical shielding", page 97](#)
- Use shielded cables with four cores (twisted pair) and surge impedance of  $120\ \Omega$  (CAN\_H, CAN\_L, CAN\_GND and CAN\_SHLD grounded).
- A CAN bus cable must not branch but short stub cables with T-connectors are permitted.
- Stub cables must be as short as possible.
- Maximum stub cable length:  
⇒ [Chap. "7.16.1 Cable lengths and cable cross sections", page 116](#)
- The cable between CAN\_L and CAN\_H at both CAN bus cable ends must be ended by a terminal resistor of  $120\ \Omega \pm 10\ \%$ .
- A terminal resistor can be omitted if the valve-internal terminal resistor (deactivated as standard) is activated (for configuration, see "Firmware" User Manual).
- Reference potential CAN\_GND and CAN\_SHLD may be connected to protective earth (PE) at one point only (e.g. on a connector with terminal resistor).
- The transmission rate must be adapted to the CAN bus cable length.  
⇒ [Chap. "7.16.1 Cable lengths and cable cross sections", page 116](#)
- The maximum permissible number of CAN bus nodes in the CAN network must not be exceeded.

⇒ Chap. "7.16.2 Permissible number of CAN bus nodes", page 117

- Do not lay CAN Bus cables in the immediate vicinity of disturbance sources. If interference sources cannot be avoided, use double-shielded cables.

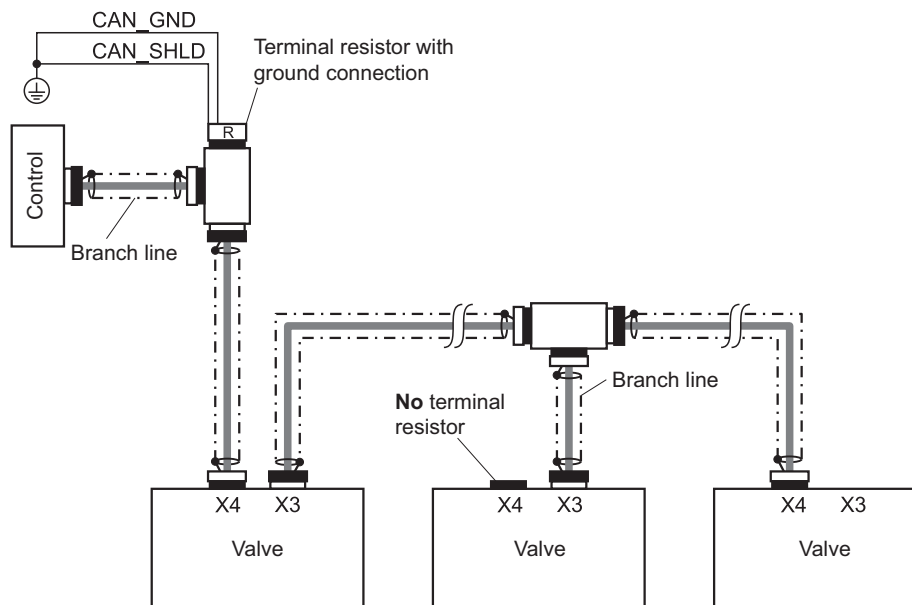

**Wiring diagram of the CAN network**

Fig. 54: CAN wiring diagram

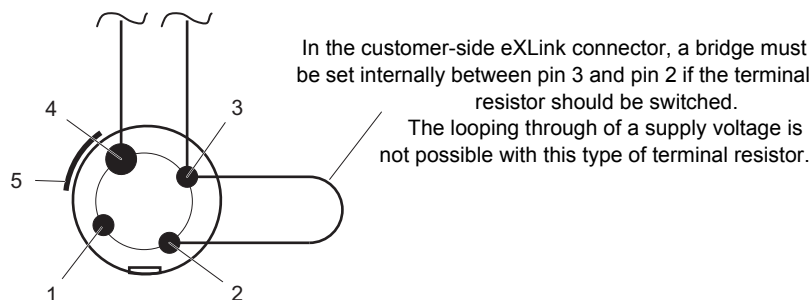

**Customer-side connection of CAN bus to the valve if terminal resistor is required**

Fig. 55: Connection of the CAN bus valve with terminal resistor



For CAN bus nodes without a galvanically isolated CAN bus interface, CAN\_GND is generally connected to supply voltage GND inside the device.

In these cases, the supply voltage connection cable must be grounded at the same point inside the machine as the CAN\_GND connection cable.

Maximum interference immunity is achieved in extensive CAN networks by using solely CAN bus nodes with galvanically isolated CAN bus interface.

If it is not possible to dispense with CAN bus nodes without galvanically isolated CAN bus interface, arrange these nodes in the immediate vicinity of the central ground point. The cable length to this central ground point is to be kept as short as possible. It is particularly important in this respect to ensure that the equipotential bonding line is properly dimensioned!

**Interference immunity in CAN networks**

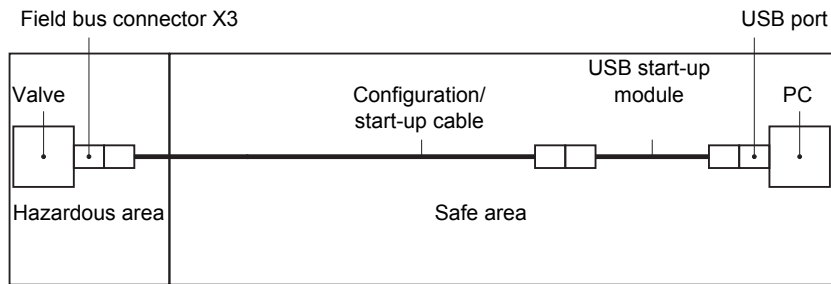

**Connection of the valve to a PC via the CAN bus interface (X3)**

Fig. 56: Connection of the valve to a PC via the CAN bus interface (field bus connector X3)

## DANGER



### **Danger of explosion!**

To guarantee safe operation in hazardous area:

- ▶ In its standard model with screw plug, the service connector X10 is not permitted for use in hazardous area.
- ▶ For mounting of the screw plug of the service connector X10, it must be observed that the gasket and the threads of the screw plug as well as the threads in the electronic housing of the valve are not damaged.
- ▶ In case of damage to the screw plug of the service connector or the threads in the electronic housing, the valve must not be operated in an hazardous area.
- ▶ Tightening torque screw plug:  
     ⇒ [Chap. "3.1.2 Representative depiction of the valve", page 18](#)



The use of the service interface is only permitted outside the hazardous area.

## 7.16.1 Cable lengths and cable cross sections

Transmission rate	Maximum cable length
1000 kbit/s	25 m
800 kbit/s	50 m
500 kbit/s	100 m
250 kbit/s	250 m
125 kbit/s	500 m
100 kbit/s	650 m
50 kbit/s	1000 m
20 kbit/s	2500 m

**Cable lengths and cable cross sections**

Tab. 15: Recommendation for maximum cable lengths in CAN networks, depending on the transmission rate

Cable cross section	Maximum cable length for n CAN bus nodes		
	n = 32	n = 64	n = 100
0.25 mm <sup>2</sup>	200 m	170 m	150 m
0.50 mm <sup>2</sup>	360 m	310 m	270 m
0.75 mm <sup>2</sup>	550 m	470 m	410 m

**Maximum cable length**

Tab. 16: Recommendation for maximum cable lengths in CAN networks, depending on the cable cross section and the number n of CAN bus nodes

Transmission rate	Maximum stub cable length	
	Maximum	Cumulative
1000 kbit/s	2 m	20 m
500 kbit/s	6 m	39 m
250 kbit/s	6 m	78 m
125 kbit/s	6 m	156 m

**Maximum length of stub cables**

Tab. 17: Maximum permissible stub cable lengths in CAN networks

### 7.16.1.1 Suitable cable types for CAN networks

Parameter	Value
Surge impedance	120 Ω

**Suitable cable types for CAN networks**

Tab. 18: Specification of electrical data for CAN bus cables

Manufacturer	Cable type
Web: <a href="http://www.draka-mog.com">http://www.draka-mog.com</a>	Draka ToughCAT7 Mud Protected

Tab. 19: Suitable cable types for CAN networks

## 7.16.2 Permissible number of CAN bus nodes

The CAN bus interface for the valve electronics supports integration in CAN networks with up to 110 CAN bus nodes.

**Maximum number  
of CAN bus nodes**

However, the maximum permissible number of CAN bus nodes can be restricted by other nodes with an older CAN bus driver to 32.

A maximum of 127 nodes can be operated in a CAN network thanks to the use of repeaters. However, it is necessary to bear in mind here the additionally inserted signal propagation time, which limits the maximum expansion of the CAN network.

## 7.16.3 CAN module address (node ID)

### CAUTION



#### Danger due to malfunctions!

A multiple use of module addresses causes malfunctions and thus corresponding dangers to people and equipment.

- ▶ Each module address may only be used once within a CAN bus network.

**CAN module address  
(node ID)**

The factory setting for the module address of the valve electronics is 127.

The module address can be changed with the LSS services (Layer Setting Services) via the CAN bus.

If there are no additional nodes present on the CAN bus, it is possible to set the node ID via the LSS Service Switch Mode Global.

To change the module address of the valve electronics with a CAN bus network, it is essential to address the valve electronics unambiguously via the LSS address. The node ID is then set via the LSS Service Switch Mode Selective.

It is also possible to configure the module address via service interface X10.



The module address of the valve electronics can also be altered with the Moog Valve and Pump Configuration Software.

## 7.16.4 CAN transmission rate



The transmission rate must be set to the same value for all the CAN bus nodes within a CAN bus network.

**CAN transmission rate**

The factory setting for the transmission rate is 500 kbit/s.



The transmission rate can be changed with the LSS services (Layer Setting Services) via the CAN bus.



The transmission rate of the valves/pumps can also be altered with the Moog Valve and Pump Configuration Software.



## 7.17 Wiring Profibus-DP networks (X3, X4)

The valves are equipped with an electrically isolated Profibus-DP interface depending on the model. The Profibus-DP interface is supplied internally.

### Wiring Profibus-DP networks

#### Procedure for connecting the valves to the Profibus-DP

#### Procedure

#### CAUTION

##### **Danger of personal injury and damage to property!**

Failure to heed safety instructions causes malfunctions and thus corresponding risks to people and equipment.

- ▶ Please heed all the safety instructions prior to and during start-up.

1. Establish the electrical connection to the Profibus-DP.  
⇒ [Chap. "7.8.2 Profibus-DP connectors", page 85](#)
2. Set the module address.  
⇒ [Chap. "7.17.3 Profibus-DP module address \(node ID\)", page 120](#)
3. Check the configuration of the valve software and the controller settings.

#### Observe the following points when wiring Profibus-DP networks:

- It is recommended to use 2-core Profibus cables so as to prevent the power supply to the terminal resistors from being connected in parallel.
- The specification [EN 61158-2](#) describes two cable types. Type B can be used with limitation.
- Stub cables must be as short as possible.
- Avoid stub cables in the case of transmission rates in excess of 1,500 kbit/s.
- If stub cables are used, do not use any terminal resistors in this branch.
- The stub cable length in the case of transmission rates in excess of 1,500 kbit/s should not exceed 6.6 m in total.

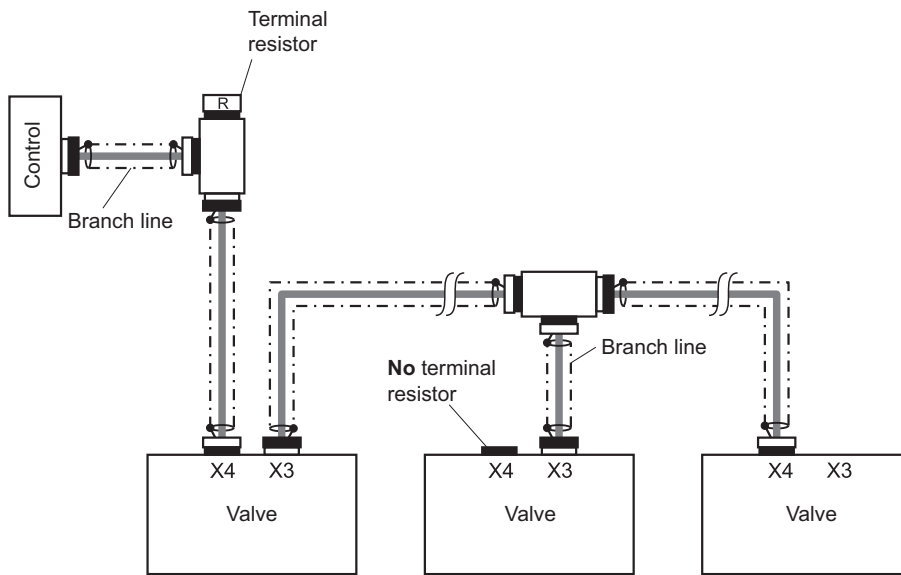

**Wiring diagram of the Profibus-DP networks**

Fig. 57: Profibus-DP wiring diagram

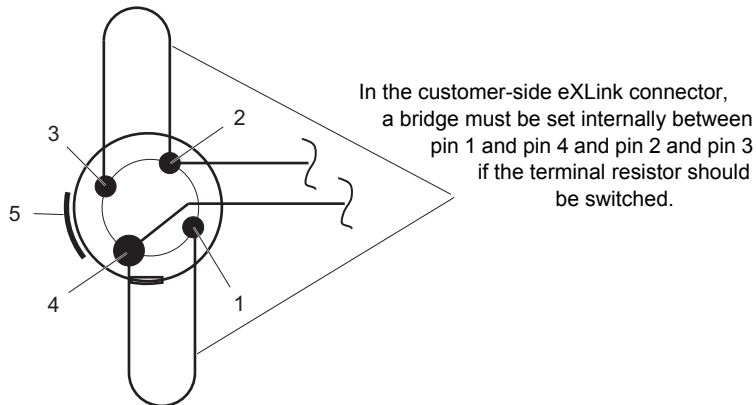

**Customer-side connection of Profibus to the valve if terminal resistor is required**

Fig. 58: Connection valve Profibus with terminal resistor

### 7.17.1 Cable lengths and cable cross sections

Transmission rate	Maximum cable length without repeaters
12,000 kbit/s	100 m
1,500 kbit/s	200 m
500 kbit/s	400 m
187.5 kbit/s	1,000 m
93.75 kbit/s	1,200 m
45.45 kbit/s	1,200 m
19.2 kbit/s	1,200 m
9.6 kbit/s	1,200 m

**Cable lengths and cable cross sections**

Tab. 20: Recommendation for maximum cable lengths in Profibus-DP networks, depending on the transmission rate

### 7.17.1.1 Suitable cable types for Profibus-DP networks

Parameter	Value
Characteristic cable impedance ( $\Omega$ )	135–165 at 3–20 MHz
Effective capacitance (pF/m)	< 30
Loop impedance ( $\Omega$ /km)	< 110
Cable diameter (mm)	> 0.64
Cable cross section (mm <sup>2</sup> )	> 0.34

Tab. 21: Specification of electrical data for Profibus-DP cables (as per type A)

**Suitable cable types for Profibus-DP networks**

Manufacturer	Cable type
Web: <a href="http://www.drakamog.com">http://www.drakamog.com</a>	Draka ToughCAT7 Mud Protected

Tab. 22: Suitable cable types for Profibus-DP networks

### 7.17.2 Permissible number of Profibus nodes

The Profibus-DP interface of the valve electronics supports integration into Profibus-DP networks with up to 32 Profibus nodes.

A maximum of 126 nodes can be operated in a Profibus-DP network with to the use of repeaters.

**Permissible number of Profibus-DP nodes**

### 7.17.3 Profibus-DP module address (node ID)

#### CAUTION



#### Danger due to malfunctions!

A multiple use of module addresses causes malfunctions and thus corresponding dangers to people and equipment.

- Each module address may only be used once within a Profibus DP network.

**Profibus-DP module address (node ID)**

The module address can be configured by sending a Set\_Slave\_Add telegram from a controller. There is also the option of configuring the module address by writing to the Profibus module identifier.

It is also possible to configure the module address via service interface X10.

The factory setting for the module address of the valve electronics is 126.



The module address of the valve electronics can also be altered with the Moog Valve and Pump Configuration Software.

### 7.17.4 Profibus-DP transmission rate

The valve electronics are automatically set to the transmission rate specified by the Profibus master. It is not possible, nor is it necessary, to configure the transmission rate on the slave side.

**Profibus-DP transmission rate**

## 7.18 Wiring EtherCAT networks (X3, X4)

The valves are equipped with an electrically isolated EtherCAT interface depending on the model. The EtherCAT interface is supplied internally.

**Wiring EtherCAT networks**

### Procedure for connecting the valves to the EtherCAT bus

**Procedure**

#### CAUTION

**Danger of personal injury and damage to property!**

Failure to heed safety instructions causes malfunctions and thus corresponding risks to people and equipment.

- ▶ Please heed all the safety instructions prior to and during start-up.

1. Establish the electrical connection to the EtherCAT bus.  
⇒ [Chap. "7.8.3 EtherCAT connectors", page 87](#)
2. Optional: Set the module address.  
⇒ [Chap. "7.18.3 EtherCAT module address \(node ID\)", page 123](#)
3. Check the configuration of the valve software and the controller settings, in particular the command signal source.



Detailed information can be found in the "Firmware" User Manual.

#### Observe the following points when wiring EtherCAT networks:

- All cables must be designed as shielded cables with twisted-pair litz wires as per [ISO/IEC 8802-3 100 Base-TX](#) and CAT 5 as per [ANSI/TIA/EIA-568-B.1](#).
- The cable length between two nodes must not exceed 100 m as per [ISO/IEC 8802-3 100 Base-TX](#).
- The maximum permissible number of EtherCAT nodes must not exceed 65,536.
- The cable between the nodes must not branch.
- An external cable termination (terminal resistor) as in CAN or Profibus-DP networks is not necessary.

**Wiring diagram of the EtherCAT network**

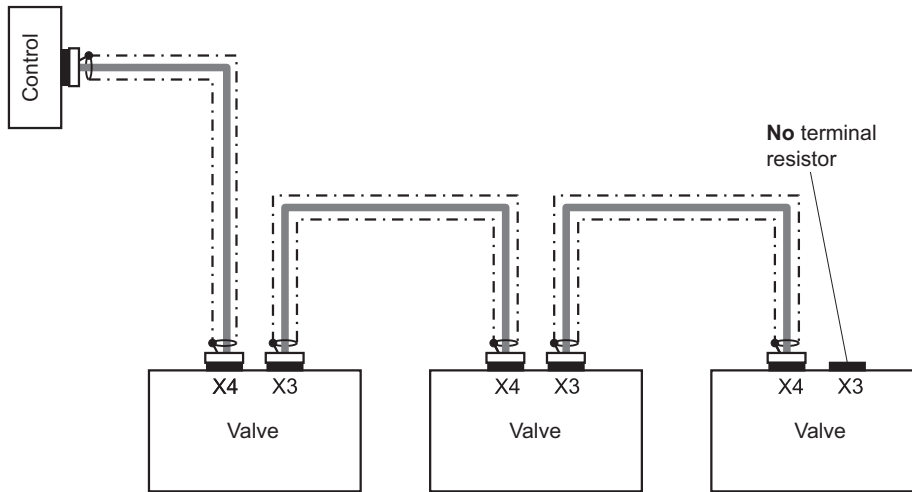

Fig. 59: EtherCAT wiring diagram

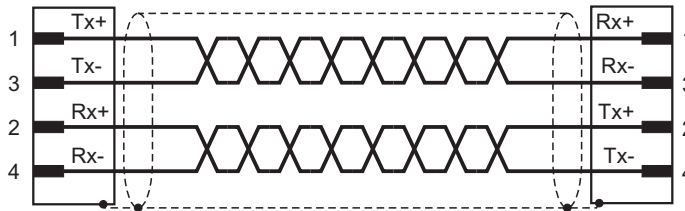

Fig. 60: Twisted-pair litz wires in Ethernet/EtherCAT cables with M12 connectors

**Pin assignment for the EtherCAT cable**

An RJ45 connector is usually used on the controller side. The colors of the litz wires are standardized in accordance with [IEEE 802.3](#) for Ethernet.

Signal	X3, X4	Litz wire	RJ45	Litz wire (RJ45, 4-core cable)
TX+	1	yellow	1	orange/white (yellow/white)
RX+	2	white	3	green/white
TX-	3	orange	2	orange
RX-	4	blue	6	green
Shield	Housing			

Tab. 23: Assignment of Ethernet/EtherCAT signals with mixed connector types

**7.18.1 Suitable cable types for EtherCAT networks**

CAT 5 cable according to [ANSI/TIA/EIA-568-B.1](#). e.g. Draka ToghCAT7 Mud Protected

**Suitable cable types for EtherCAT networks**

## 7.18.2 Permissible number of EtherCAT nodes

The EtherCAT interface of the valve electronics supports integration into EtherCAT networks with up to 65,535 EtherCAT nodes.

The maximum number of nodes in a field bus line is 216.

The number of nodes determines the signal propagation time of the data packets and the resulting possible cycle times.

**Permissible number of EtherCAT nodes**

## 7.18.3 EtherCAT module address (node ID)

### CAUTION



#### **Danger due to malfunctions!**

A multiple use of module addresses causes malfunctions and thus corresponding dangers to people and equipment.

- ▶ Each module address may only be used once within an EtherCAT network.

**EtherCAT module address (node ID)**

EtherCAT nodes can be addressed using the physical position within the network. This procedure is known as auto-increment addressing.

If position-independent addressing is preferred, a static module address can also be allocated. This addressing type is known as fixed node addressing.

### **Auto-increment addressing**

Each EtherCAT node is identified using the physical position within the network segment. For this purpose, each EtherCAT node increments a 16-bit address field within a telegram, which is sent through the entire network. The advantage of this mechanism lies in the fact that no module address has to be set manually for the field bus nodes.

### **Fixed node addressing**

With fixed node addressing a node is addressed via the so-called Configured Station Alias. This address can be configured by the network master in the Slave Information Interface (SII).

There is also the option of configuring the module address by writing to the EtherCAT module identifier.

The advantage of fixed node addressing over auto-increment addressing lies in the fact that the nodes can still be addressed at the same address even after the network topology has been changed or after nodes have been added or removed.

The factory setting for the module address of the valve electronics is 0.

It is also possible to configure the module address via service interface X10.



The module address of the valve electronics can also be altered with the Moog Valve and Pump Configuration Software.

## 7.18.4 EtherCAT transmission rate

EtherCAT works with a fixed transmission rate of 100 Mbit/s.

**EtherCAT-DP transmission rate**

## 7.19 Wiring analog inputs (X5, X6, X7)

The supply voltage for powering the transducers is available at pin 1.

**Maximum current  
of transducer supply**



There is joint fusing of this power supply for X2, X5, X6 and X7. The total supply current must therefore not exceed the following value:

$$I_{\max} (X2+X5+X6+X7) = 300 \text{ mA}$$

An external power supply to the transducer is also possible. However, the 0 V transducer supply must be connected to supply zero. An interruption of the transducer supply current can be identified as a cable break (see "Firmware" User Manual).

The supply voltage is cut off in the event of a possible short circuit in the supply voltage to the transducer. A fault reaction can be configured (see "Firmware" User Manual). The voltage is available again as soon as the short circuit has been eliminated.

The supply current for each transducer is monitored for the purpose of detecting cable breaks. Supply currents under 1 mA can trigger a configurable fault reaction.

2/3/4-wire transducers with a voltage or current output can be connected to X5, X6 and X7. Each input can be individually adapted.

## 2-wire transducers

2-wire transducers can only be operated in the signal type for the 0–10 mA or 4–20 mA analog input in the single-ended version.

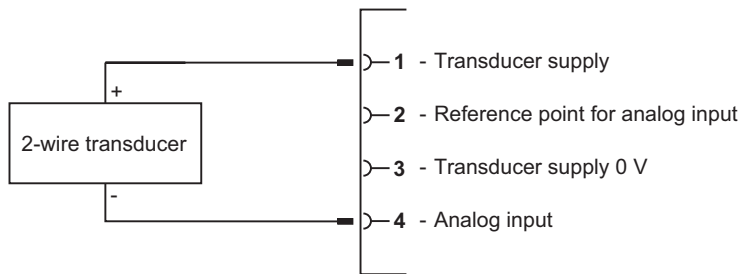

### Wiring the 2-wire transducer

Fig. 61: Connecting a 2-wire transducer to analog input connectors X5, X6 or X7

## 3-wire transducers

3-wire transducers can only be operated in the single-ended version.

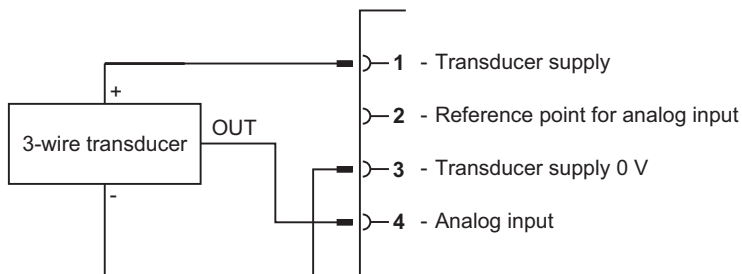

### Wiring the 3-wire transducer

Fig. 62: Connecting a 3-wire transducer to analog input connectors X5, X6 or X7

## 4-wire transducers

4-wire transducers should be operated in the differential version.

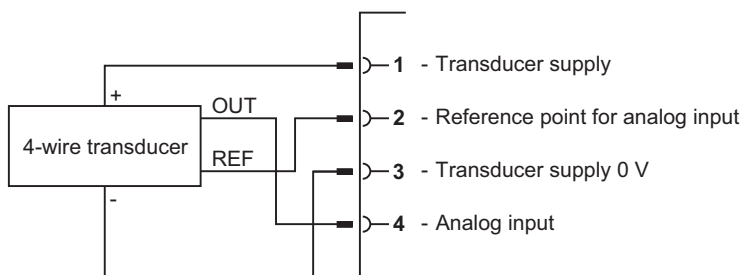

### Wiring the 4-wire transducer

Fig. 63: Connecting a 4-wire transducer to analog input connectors X5, X6 or X7



## 7.20 Electrical start-up

### DANGER



#### Danger of explosion!

An explosion can be triggered by sparks when switching on the machine.

- ▶ Open connectors for the interface must absolutely be covered before start-up.
- ▶ The eXLink connectors from CEAG must be mounted according to the instructions in the operating instructions for the eXLink connector.
- ▶ In its standard model with screw plug, the service connector X10 is not permitted for use in hazardous area.
- ▶ The service connector X10 in the standard model M8, 3-pin must be sealed with the original screw plug belonging to the valve before start-up.
- ▶ For mounting of the screw plug of the service connector X10, it must be observed that the gasket and the threads of the screw plug as well as the threads in the electronic housing of the valve are not damaged.
- ▶ In case of damage to the screw plug of the service connector X10 or the threads in the electronic housing, the valve must not be operated.
- ▶ Tightening torque screw plug:  
⇒ [Chap. "3.1.2 Representative depiction of the valve", page 18](#)

### WARNING



#### Danger of explosion

To guarantee safe operation in hazardous area:

- ▶ The signal interfaces of the valve are implemented with explosion-proof connectors.
- ▶ For mounting and removal of the connectors as well as operation of the valve, the notes and instructions in the "Explosion-proof connectors eXLink, CEAG" operating instructions must absolutely be adhered to.

### WARNING



#### Danger of explosion

For electrical start-up, cables on the valve, cable glands, screw plugs, and connectors must not be damaged.

- ▶ The valve must not be started up with damaged cables, plug connectors, and screw plugs, and it must be sent to us or to one of our authorized service centers immediately.



For the standard model of the valve, the service interface is not suitable for use in hazardous area. On request, the service interface is available in an explosion-proof model.

## 7.21 Electromagnetic compatibility (EMC)

The machine manufacturer is responsible for complying with the EMC Directive.

### EMC requirements

The valves fulfill the EMC protection requirements for interference immunity as per [EN 61000-6-2](#) (evaluation criterion A) and for emitted interference as per [EN 61000-6-4](#) (CAN bus and Profibus-DP) or as per [EN 61000-6-3](#) (Ethernet-CAT).

The following technical requirements must be in place so that the EMC protection requirements can be satisfied:

- Use of the mating connectors recommended for the valves.  
⇒ [Chap. "12.1 Accessories", page 173](#)
- Adequate shielding.
- Correct execution of equipotential bonding system, protective grounding and electrical shielding.  
⇒ [Chap. "7.12 Protective grounding and electrical shielding", page 97](#)

## 7.22 Communication via the Moog Valve and Pump Configuration Software

### CAUTION

**Danger of personal injury and damage to property!**

Improper handling of the Moog Valve and Pump Configuration Software causes malfunctions and thus corresponding risks to people and equipment.

- ▶ For safety reasons, the Moog Valve and Pump Configuration Software must not be used inside a machine for visualization purposes or as an operator terminal.

### CAUTION

**Danger of personal injury and damage to property!**

It is not permitted to operate the Moog Valve and Pump Configuration Software on a field bus while the machine is running.

It is only permitted to activate valves via the Moog Valve and Pump Configuration Software if this does not cause any dangerous states in the machine and in its surroundings.

### CAUTION

**Danger of personal injury and damage to property!**

Activating valves via the Moog Valve and Pump Configuration Software within a network can give rise to unforeseeable events if field bus communication takes place simultaneously between the machine control or other bus nodes!

- ▶ Deactivate the field bus communication for machine control and other bus nodes.

### CAUTION

**Danger of personal injury and damage to property!**

Messages from the Moog Valve and Pump Configuration Software can also be received by other bus nodes. This may trigger unforeseeable events.

- ▶ Deactivate the field bus communication for machine control and other bus nodes.

**CAUTION****Danger of personal injury and damage to property!**

If danger-free operation of the valves via the Moog Valve and Pump Configuration Software can also not be ensured with deactivated field bus communication to the machine control and other bus nodes, the following must be heeded:

- ▶ The valves may only communicate depressurized and in a direct connection (point-to-point) with the Moog Valve and Pump Configuration Software.

**CAUTION****Data loss!**

Data communication between the valve electronics and the Moog Valve and Pump Configuration Software may be disrupted if other field bus nodes (e.g. a controller) are accessing the valve electronics at the same time.

- ▶ Deactivate the field bus communication for machine control.

**Operation of the Moog Valve and Pump Configuration Software**

The Moog Valve and Pump Configuration Software communicates with the valves via the CAN interface. The CAN interface is either on the service interface X10 or available on the CAN field bus interface X3 and X4.

If the Moog Valve and Pump Configuration Software is operated within a CAN network with field bus communication of the machine running, the following faults can occur:

- Data exchange with the valve may be disrupted if another device (such as a controller) accesses the valve simultaneously.
- Node guarding may be activated only if no other field bus node is monitoring the valves via this service.
- Field bus telegrams can also be received by other field bus nodes. This may trigger off unforeseeable events!

To establish a direct connection between Moog Valve and Pump Configuration Software and valve, detach the field bus cable from the valve and connect the valve directly to the USB CAN interface of the service PC. A  $120 \Omega \pm 10 \%$  terminal resistor is required here.

The configuration/start-up cable not included in the scope of delivery already features a terminal resistor. This configuration/start-up cable can only be used outside of areas subject to explosion. The cable can only be used in connection with the M8-M12 adapter and thus only on the service connector X10.

⇒ [Chap. "12.1 Accessories", page 173](#)

**Possible faults**

## 8 Start-up

Safety notes: start-up

### DANGER



#### Danger to life!

Operating machines with damaged or defective components or with a leaking hydraulic system is dangerous and not permitted.

- ▶ Before starting up or operating the valve, check the higher-level machine including all its installed components for damage and defects.
- ▶ Pay particular attention here to higher-level and hydraulic safety devices such as, for example, EMERGENCY STOP switches and pressure-limiting valves.
- ▶ Report damage or defects to the relevant department immediately. If necessary, stop the machine immediately and secure it.
- ▶ Rectify any leaks immediately in accordance with this user manual, paying particular attention to the notes/instructions on handling in accordance with safety requirements.
- ▶ ⇒ Chap. "2.1 Handling in accordance with safety requirements", page 14
- ▶ ⇒ Chap. "10.3 Trouble shooting", page 158

### DANGER



#### Danger of explosion!

To guarantee safe operation in hazardous area:

- ▶ In its standard model with screw plug, the service connector X10 is not permitted for use in hazardous area.
- ▶ For mounting of the screw plug of the service connector X10, it must be observed that the gasket and the threads of the screw plug as well as the threads in the electronic housing of the valve are not damaged.
- ▶ In case of damage to the screw plug of the service connector or the threads in the electronic housing, the valve must not be operated in an hazardous area.
- ▶ Tightening torque screw plug:  
⇒ Chap. "3.1.2 Representative depiction of the valve", page 18

### DANGER



#### Danger of explosion!

To guarantee safe operation in hazardous areas:

- ▶ The signal interfaces of the valve are implemented with explosion-proof connectors.
- ▶ For mounting and removal of the plug connectors as well as operation of the valve, the notes and instructions in the "Explosion-proof connectors eXLink, CEAG" operating instructions must absolutely be adhered to.
- ▶ The eXLink operating instructions from CEAG are in the Appendix to this user manual.

**DANGER****Danger of poisoning and injury due to hydraulic fluid squirting out under pressure!**

Contact with hydraulic fluids can damage your health (e.g. eye injuries, skin and tissue damage, poisoning in case of inhaling).

- ▶ Wear protective gloves and safety glasses.
- ▶ If hydraulic fluid gets into your eyes or on your skin, consult a doctor immediately.
- ▶ When handling hydraulic fluids, observe the safety provisions applicable to the hydraulic fluid used.

**DANGER****Danger of injury due to electric voltage and unexpected movements!**

Work on machines that are not shut down presents a danger to life and limb. Work such as mounting or removal, electrical or hydraulic connection, troubleshooting or service may only be performed on machines and valves that are shut down.

- ▶ Make sure to shut the machine down and switch it off.
- ▶ Make sure that the drive motor cannot be switched on.
- ▶ For this purpose, switch off the supply voltage as well as that of connected peripherals, such as externally powered transducers or programming units.
- ▶ Make sure that all power-transmitting components and connections (electrical and hydraulic) are switched off according to the manufacturer's instructions and secured against switching on again. If possible, remove the main fuse from the machine.
- ▶ Make sure that the machine is completely depressurized.

**DANGER****Danger of explosion!**

Open connectors for the interface must absolutely be covered before start-up.

- ▶ The interfaces must be sealed with the original screw plug belonging to the valve.

**DANGER****Danger of explosion**

The unsafe operation of the valves is dangerous.

- ▶ Only operate the valve when it is in a safe and functional state.
- ▶ At least once per shift, check the valve for damage visible from the outside and defects such as leakage or damaged cables or connectors.
- ▶ Report changes, including to the operating behavior, damage, and defects to the responsible department immediately. If necessary, stop the machine immediately and secure it.
- ▶ The cable glands must be checked at regularly-prescribed intervals. For details, see standard DIN EN 60079-17.
- ▶ ⇒ Chap. "2.1 Handling in accordance with safety requirements", page 14
- ▶ ⇒ Chap. "10.3 Trouble shooting", page 158

**DANGER****Danger of explosion!**

An explosion can be triggered by sparks when switching on the machine.

- ▶ Open connectors for the interface must absolutely be covered before start-up.
- ▶ The eXLink connectors from CEAG must be mounted according to the instructions in the operating instructions for the eXLink connector.
- ▶ In its standard model with screw plug, the service connector X10 is not permitted for use in hazardous area.
- ▶ The service connector X10 in the standard model M8, 3-pin must be sealed with the original screw plug belonging to the valve before start-up.
- ▶ For mounting of the screw plug of the service connector X10, it must be observed that the gasket and the threads of the screw plug as well as the threads in the electronic housing of the valve are not damaged.
- ▶ In case of damage to the screw plug of the service connector X10 or the threads in the electronic housing, the valve must not be operated.
- ▶ Tightening torque screw plug:  
⇒ Chap. "3.1.2 Representative depiction of the valve", page 18

**WARNING****Danger of explosion**

For electrical start-up, cables on the valve, cable glands, screw plugs, and connectors must not be damaged.

- ▶ The valve must not be started up with damaged cables, plug connectors, and screw plugs, and it must be sent to us or to one of our authorized service centers immediately.

**WARNING****Danger of personal injury and damage to property!**

The operation of the valves at pressure that is too high on the hydraulic connections can cause injuries and damage to the machine.

- ▶ Pressure-limiting valves or other comparable safety devices, for example, must be installed to limit the pressure at all the hydraulic ports to the specified maximum operating pressure. Maximum operating pressure:  
⇒ [Chap. "11 Technical Data", page 164](#)

**WARNING****Risk of injury!**

To provide protection against injuries or other damaging influences on health, suitable protective measures must be taken if necessary prior to and when carrying out any work on the valves or the machine, such as mounting or removing, electrical or hydraulic connection, trouble shooting or servicing, and when handling the valves, accessories, tools or hydraulic fluids.

- ▶ ⇒ [Chap. "2.2 Occupational safety and health", page 15](#)

**CAUTION****Danger of personal injury and damage to property!**

By changing the configuration of the valves, the functionality of the valve can be changed so that it causes damage, malfunction or failure of the valve or machine.

- ▶ It is only permitted to alter the valve configuration during operation if this does not cause any dangerous states in the machine and in its surroundings.

**CAUTION****Danger of personal injury and damage to property!**

Working with and on the valves without the required basic mechanical, hydraulic, and electrical knowledge may cause injuries or parts may be damaged.

- ▶ Only properly qualified and authorized users may work with and on the valves.
- ▶ ⇒ [Chap. "1.4 Selection and qualification of personnel", page 7](#)



## CAUTION

### **Risk of damage due to dirt and moisture!**

This is the only way of adequately protecting the valves against the penetration of dirt and moisture and protecting the gaskets/ seals against the effects of ozone and UV.

- ▶ The valves must not be transported or stored without their shipping plate fitted.
  - ▶ The valve shipping plate may only be removed from the valve hydraulic ports directly prior to mounting and must be reinstalled directly after the valve has been removed.
  - ▶ The shipping plate and the associated fastening elements (screws and nuts) must be kept for later use, e.g. during transportation.
-

## 8.1 Preparations

**The valves may only be started up when the following is ensured:**

- The higher-level machine with all its installed components complies with the latest versions of the relevant national and international regulations, standards and guidelines (such as, for example, the EU Machinery Directive, the regulations of the trade association and of TÜV or VDE).
- The valves and all the other installed components are in a technically fault-free and operationally reliable state.
- No signals that can lead to uncontrolled movements in the machine are transmitted to the valves.

⇒ [Chap. "1.3 Intended operation", page 5](#)

**Preparations for start-up**

## 8.2 Start-up of the valves

### Procedure:

1. Make sure that all the machine components, connections and ports conform to the specifications of the machine manufacturer and operator.
2. Prepare the hydraulic system.  
⇒ Chap. "8.4 Filling and flushing the hydraulic system", page 141
3. Establish the valve hydraulic connection.  
⇒ Chap. "6.3 Mounting the valve", page 65
4. Establish the valve electrical connection.  
⇒ Chap. "7 Electrical connection", page 68
5. Valves with field bus interface:  
Connect the valve to the field bus.
6. Make sure that all the mechanical and electrical connections and hydraulic ports are correctly established. Follow operating instructions for the ex-proof plug connector!
7. Make sure that the valve is correctly configured, or carry out configuration.  
⇒ Chap. "3.5 Valve software", page 49  
⇒ Chap. "8.3 Configuration of the valves", page 136
8. Start-up of the hydraulic system.  
⇒ Chap. "8.5 Start-up of the hydraulic system", page 142
9. If necessary, correct the zero position parameters in the valve software. The parameters can be set or interrogated via the service or field bus interface in the valve software. Setting and interrogation can be performed for example with the Moog Valve and Pump Configuration Software.



High pressure peaks in the hydraulic system can result in a drift of the valve's internal pressure transducer.

To monitor any possible drift of the valve's pressure transducer, we recommend that the pressure transducer be checked 3, 6 and 12 months after the valve is started up and thereafter at intervals of 6 months. This can be conducted for example using comparison measurements with a calibrated pressure gauge. If necessary, the internal pressure transducer must be recalibrated.

The pressure transducer can be influenced by means of parameters in the valve software. The parameters can be set or interrogated via the service or field bus interface in the valve software. Setting and query can, for example, take place with the Moog Valve and Pump Configuration Software.

### Procedure for start-up

### Monitoring the pressure transducer drift

## 8.3 Configuration of the valves

### CAUTION



#### Danger of personal injury and damage to property!

By changing the configuration of the valves, the functionality of the valve can be changed so that it causes damage, malfunction or failure of the valve or machine.

- ▶ It is only permitted to alter the valve configuration during operation if this does not cause any dangerous states in the machine and in its surroundings.

### Safety instructions: configuration of the valves

**CAUTION****Danger of personal injury and damage to property!**

The selected settings must be documented after the configuration of the valves has been altered.

The settings can be documented for example with the Moog Valve and Pump Configuration Software.

- ▶ After a valve has been repaired or replaced, the user must transfer the settings again to the repaired or new valve because repaired or replacement valves are like new valves delivered with factory settings.
- ▶ ⇒ Chap. "8.3.3 Factory setting of the valves", page 140
- ▶ ⇒ Chap. "10.4 Repair", page 162

The Moog Valve and Pump Configuration Software is available as an accessory to simplify start-up, diagnosis and configuration of the valves.

⇒ Chap. "3.6 Moog Valve and Pump Configuration Software", page 50

### 8.3.1 Configuration via the field bus interface

Valves with field bus interfaces are started up, activated, monitored and configured via the field bus interface (connectors X3 and X4).

**Configuration of  
the valves via the  
field bus interface**

#### 8.3.1.1 Configuration with the machine controller

To be able to configure the valves with the machine controller, it is necessary to connect the valve to the machine controller via the field bus.

**Configuration with  
the machine controller**

### 8.3.1.2 Configuration with the Moog Valve and Pump Configuration Software

The Moog Valve and Pump Configuration Software communicates with the valves via the CAN bus interface. The CAN bus interface is either on the service interface X10 or available on the CAN field bus interface X3 and X4.

⇒ [Chap. "7.22 Communication via the Moog Valve and Pump Configuration Software"](#), page 128

**Configuration with  
the Moog Valve and Pump  
Configuration Software**

### 8.3.2 Configuration via the service interface

Valves without CAN bus interfaces can be started up and configured via the service interface (service connector-X10) with the Moog Valve and Pump Configuration Software.

⇒ Chap. "3.6 Moog Valve and Pump Configuration Software", page 50

**Configuration of the valves via the service interface**

#### DANGER



#### Danger of explosion!

To guarantee safe operation in hazardous area:

- ▶ In its standard model with screw plug, the service connector X10 is not permitted for use in hazardous area.
- ▶ For mounting of the screw plug of the service connector X10, it must be observed that the gasket and the threads of the screw plug as well as the threads in the electronic housing of the valve are not damaged.
- ▶ In case of damage to the screw plug of the service connector or the threads in the electronic housing, the valve must not be operated in an hazardous area.
- ▶ Tightening torque screw plug:  
⇒ Chap. "3.1.2 Representative depiction of the valve", page 18



For the standard model of the valve, the service interface is not suitable for use in hazardous areas.

On request, the service interface is available in an explosion-proof model.

The following are required to be able to configure the valves with the Moog Valve and Pump Configuration Software via the service interface (service connector -X10):

- USB start-up module for the use in hazardous areas not allowed
- Configuration/start-up cable
- Adapter for service connector X10 for use in hazardous areas not allowed, optional available with Ex-protected plug connector
- PC with installed Moog Valve and Pump Configuration Software



USB start-up module, configuration/start-up cable, adapter, and Moog Valve Configuration Software are available as accessories.

⇒ Chap. "12.1 Accessories", page 173

To be able to configure the valves via the service interface, it is necessary to connect the valve as follows to the PC with installed Moog Valve and Pump Configuration Software:

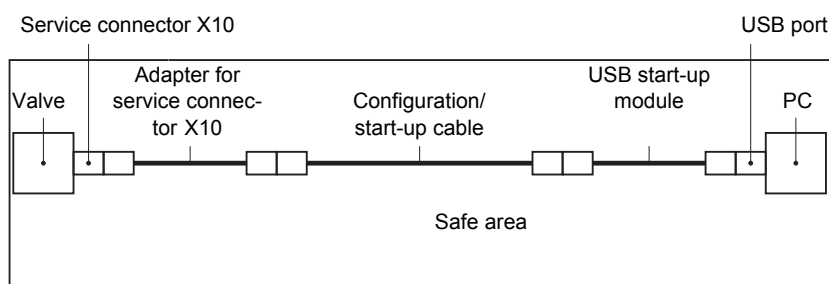

Fig. 64: Connection of the valve to a PC via the service interface (service connector X10)

**Connection of the valve to a PC via the service interface (X10)**

### 8.3.3 Factory setting of the valves

The valve is delivered from the factory with preset parameters. This presetting corresponds to the factory setting of the valves.

Depending on the valve type and model, it may be necessary to adapt the parameters for the pressure controller to the respective application.

If the valve is to be incorporated in a field bus, it may also be necessary to adapt the communication parameters.

#### Factory setting of the valves



Please contact Moog or one of its authorized service centers for information on the factory setting parameters.

### 8.3.4 Storing of parameters

Modified parameters are initially stored in the volatile memory of the valve electronics microprocessor system, i.e. they are lost if the power supply is interrupted. When the power supply is restored, the parameters that were stored last are again available.

#### Volatile memory

The microprocessor system also has a non-volatile memory. In order to store the modified parameters in this memory, it is necessary to send a memory command to the valve. If the power supply is interrupted, the modified valve configuration will again be available after the supply is restored.

#### Non-volatile memory

## 8.4 Filling and flushing the hydraulic system

### WARNING



#### Risk of injury!

In order to prevent injuries and other damage to health when flushing the hydraulic system, please observe the following notes.

- ▶ The manufacturer and operator of the machine are responsible for making sure that for safety-critical use, relevant safety standards in the latest version, which serve to avoid damage, are heeded.
- ▶ It is vital among other things to ensure that both the individual components and the complete machine can be rendered in a safe state.
- ▶ If a switching valve is fitted to flush the hydraulic system, this must not cause any potentially dangerous states in the machine.

#### Procedure:

1. Depressurize the hydraulic system.
2. Fill the hydraulic system in accordance with the instructions of the manufacturer and the operator of the machine.  
Since new hydraulic fluid is impure, the hydraulic system must be filled using a fill filter with a filter fineness of at least  $\beta_{10} \geq 75$  (10  $\mu\text{m}$  absolute).
3. Replace existing filter elements with flushing elements in accordance with the instructions of the manufacturer and the operator of the machine.
4. Remove the servo valve.  
⇒ [Chap. "10.1 Removing of the valves", page 155](#)
5. Instead of the servo valve, you must install a flushing plate or, if allowed by the hydraulic system, a switching valve.



Use the flushing plate to flush lines P and T.

The switching valve can also be used to flush the actuator with lines A and B.



The flushing plates are not included in the valve scope of delivery. They are available as an accessory.

⇒ [Chap. "12.1 Accessories", page 173](#)

#### Procedure for filling and flushing the hydraulic system



6. Carefully flush the hydraulic system in accordance with the instructions of the manufacturer and the operator of the machine. Observe the following when doing so:

- In order to obtain the best possible flushing effect, make sure the hydraulic fluid reaches operating temperature.
- Observe the minimum flushing time t:

$$t = 5 \cdot \frac{V}{Q} \quad [\text{h}]$$

V [l] : Tank capacity

Q [l/min] : Pump delivery

- End the flushing process when at least the cleanliness level as specified in 18/15/12 ISO 4406 is achieved.

7. Depressurize the hydraulic system.

8. Replace flushing elements with suitable filter elements in accordance with the instructions of the manufacturer and the operator of the machine.

9. Remove the flushing plate or switching valve.

10. Mount the servo valve.

⇒ Chap. "6.3 Mounting the valve", page 65

## 8.5 Start-up of the hydraulic system

### Procedure:

1. Start-up the hydraulic system in accordance with the instructions of the manufacturer and the operator of the machine.
2. Vent the hydraulic system in accordance with the instructions of the manufacturer and the operator of the machine.
3. Vent the valve (only for D639K).  
⇒ Chap. "8.5.1 Venting", page 142  
It may be necessary to repeat the procedure.
4. Check the hydraulic system for external leaks.

### Procedure for start-up of the hydraulic system

### 8.5.1 Venting

#### CAUTION

##### Risk of damage!

Air trapped in the hydraulic system, particularly in the case of high pressure peaks in the system, can cause a diesel effect. If the trapped air bubbles are compressed very quickly and thus heated, this can cause the mixture to self-ignite. This gives rise to a very high increase in pressure and temperature locally, which in turn can result in damage in the hydraulic system, e.g. to gaskets or components, causing the oil to age more quickly.

- ▶ In order to avoid diesel effects, the hydraulic system must be ventilated.

### 8.5.1.1 Tool required

The following tool is required for venting the valve:

- Torque wrench for 5 WAF hexagon socket screws

**Required tool for venting the valves**

### 8.5.1.2 Venting the valve and the actuator

#### WARNING



#### Risk of injury!

In order to prevent injuries and other damage to health when venting the hydraulic system, please observe the following notes.

- ▶ The manufacturer and operator of the machine are responsible for making sure that for safety-critical use, relevant safety standards in the latest version, which serve to avoid damage, are heeded.
- ▶ It is vital among other things to ensure that both the individual components and the complete machine can be rendered in a safe state.
- ▶ The valve and actuator may only be vented at a low system pressure of max. 10 bar (145 psi).

#### Procedure:

1. A low system pressure of max. 10 bar (145 psi) must be applied.
2. Input valve command signals so that the pressure-controlled port is pressurized with system pressure.
3. Carefully open the venting screw by approx. one revolution.  
Position of the venting screw: ⇒ [Fig. 1, page 18](#)
4. Wait until no additional air escapes or until the escaping hydraulic fluid contains no additional air bubbles.
5. If necessary, tighten venting screw with torque wrench for hexagon socket head cap screws WS 5.  
Tightening torque of the venting screw: 15 Nm / 11 lbf ft.  
Higher tightening torques can result in the destruction of the sealing ring for the venting screw.
6. Remove the escaped hydraulic fluid.
7. If the actuator is higher than the valve, the actuator must likewise be vented at the highest point.

**Procedure for venting the valve and the actuator**

## 9 Operation

Safety notes: Operation

### DANGER

**Danger to life!**

Operating machines with damaged or defective components or with a leaking hydraulic system is dangerous and not permitted.

- ▶ Before starting up or operating the valve, check the higher-level machine including all its installed components for damage and defects.
- ▶ Pay particular attention here to higher-level and hydraulic safety devices such as, for example, EMERGENCY STOP switches and pressure-limiting valves.
- ▶ Report damage or defects to the relevant department immediately. If necessary, stop the machine immediately and secure it.
- ▶ Rectify any leaks immediately in accordance with this user manual, paying particular attention to the notes/instructions on handling in accordance with safety requirements.
- ▶ ⇒ Chap. "2.1 Handling in accordance with safety requirements", page 14
- ▶ ⇒ Chap. "10.3 Trouble shooting", page 158

### DANGER

**Danger of injury due to electric voltage and unexpected movements!**

Work on machines that are not shut down presents a danger to life and limb. Work such as mounting or removal, electrical or hydraulic connection, troubleshooting or service may only be performed on machines and valves that are shut down.

- ▶ Make sure to shut the machine down and switch it off.
- ▶ Make sure that the drive motor cannot be switched on.
- ▶ For this purpose, switch off the supply voltage as well as that of connected peripherals, such as externally powered transducers or programming units.
- ▶ Make sure that all power-transmitting components and connections (electrical and hydraulic) are switched off according to the manufacturer's instructions and secured against switching on again. If possible, remove the main fuse from the machine.
- ▶ Make sure that the machine is completely depressurized.

### DANGER

**Danger of personal injury and damage to property!**

Failure to heed the eXLink operating instructions from CEAG can cause bodily injuries and property damage.

- ▶ Follow the eXLink operating instructions from CEAG in the Appendix to this user manual.
- ▶ Handle all ex-protected connectors according to the notes and instructions in the eXLink operating instructions from CEAG

**DANGER****Danger of explosion!**

The unsafe operation of the valves is dangerous.

- ▶ Only operate the valve when it is in a safe and functional state.
- ▶ At least once per shift, check valve for damage visible from the outside and defects such as leakage or damaged cables or connectors.
- ▶ Report changes, including to the operating behavior, damage, and defects to the responsible department immediately. If necessary, stop the machine immediately and secure it.
- ▶ ⇒ [Chap. "2.1 Handling in accordance with safety requirements", page 14](#)
- ▶ ⇒ [Chap. "10.3 Trouble shooting", page 158](#)

**DANGER****Danger of explosion!**

The unsafe operation of the valves is dangerous and not permitted.

- ▶ Open connectors for the interfaces are not permitted and must absolutely be covered before start-up.
- ▶ The eXLink connectors from CEAG must be mounted correctly according to the instructions in the "Ex plug connector eXLink" operating instructions. Here the instructions and notes in the operating instructions for the connectors must be heeded.
- ▶ Only use the service connector X10 in the M8 mode, 3-pin outside the hazardous area.
- ▶ The service connector X10 in the standard model M8, 3-pin must be sealed with the original screw plug belonging to the valve before start-up.
- ▶ For a configuration of the valve within the area subject to explosion, on request there is the X10 interface with an appropriate Ex-protected plug connector.

**DANGER****Danger of explosion due to impermissible heating up of the valve!**

As a result of insufficient ventilation of the valve or deposits on the valve, the impermissible heating up of the valve can be such that the maximum temperatures of the certified temperature classes are exceeded.

- ▶ The valves must be checked regularly, cleaned if necessary. Deposits on the valve must be removed.
- ▶ If necessary inform the responsible person immediately and remove the valve from electrical and hydraulic operation.

**WARNING****Danger of explosion!**

During operation, cables on the valve, cable glands, screw plugs, and connectors must not be damaged.

- ▶ The valve must not be started up with damaged cables, connectors, and screw plugs, and it must be sent to us or to one of our authorized service centers immediately.

**WARNING****Risk of injury!**

To provide protection against injuries or other damaging influences on health, suitable protective measures must be taken if necessary prior to and when carrying out any work on the valves or the machine, such as mounting or removing, electrical or hydraulic connection, trouble shooting or servicing, and when handling the valves, accessories, tools or hydraulic fluids.

- ▶ ⇒ [Chap. "2.2 Occupational safety and health", page 15](#)

**CAUTION****Danger of personal injury and damage to property!**

By changing the configuration of the valves, the functionality of the valve can be changed so that it causes damage, malfunction or failure of the valve or machine.

- ▶ It is only permitted to alter the valve configuration during operation if this does not cause any dangerous states in the machine and in its surroundings.

**CAUTION****Danger of personal injury and damage to property!**

In addition, to avoid damage or leaks, perform the following tasks at regular intervals in accordance with the instructions of the manufacturer and the operator of the machine:

- ▶ Checking the valve and the hydraulic system for externally identifiable damage and defects.
- ▶ Checking for loose plugs/connectors.
- ▶ Checking the cleanliness level of the hydraulic fluid.
- ▶ Checking the port O-rings for elasticity, integrity and correct seating.
- ▶ ⇒ [Chap. "10.2.1 Checking and replacing the port O-rings", page 157](#)

**CAUTION****Danger of personal injury and damage to property!**

It is not permitted to operate the Moog Valve and Pump Configuration Software on a field bus while the machine is running.

It is only permitted to activate valves via the Moog Valve and Pump Configuration Software if this does not cause any dangerous states in the machine and in its surroundings.

**CAUTION****Danger of personal injury and damage to property!**

Working with and on the valves without the required basic mechanical, hydraulic, and electrical knowledge may cause injuries or parts may be damaged.

- ▶ Only properly qualified and authorized users may work with and on the valves.
- ▶ ⇒ [Chap. "1.4 Selection and qualification of personnel", page 7](#)

**CAUTION****Risk of damage!**

In order to prevent damage to the valves or to the machine, heed the following points:

- ▶ Values specified in the technical data must be adhered to.
- ▶ Values specified on the nameplate must be adhered to.
- ▶ ⇒ [Chap. "11 Technical Data", page 164](#)

## 9.1 Preparations for operation

The valves may only be operated as a component part of a higher-level overall system, for example in a machine.

⇒ [Chap. "2 Safety", page 14](#)

The following must be completed before the valve is operated:

- Qualified project planning
- Correct start-up and configuration of the valve  
⇒ [Chap. "8 Start-up", page 130](#)

### Preparations for valve operation

## 9.2 Operation of the valve

The valve is activated via signals that it receives from the machine controller.

**Operation of the valve:  
activation via signals from  
the machine controller**

**Direct interventions by the user on the valve during normal operation are not necessary. The valve has no controls, such as e.g. switches or buttons, which must be actuated.**

The device may only be operated in a safe and functional state. Here, the following points must be heeded:

- At least once per shift, check valve for damage visible from the outside and defects such as leakage or damaged cables or connectors.
- Report changes, including those in the operating behavior, as well as functional faults to the responsible person or office.
- Shut the machine to down immediately and secure.
- Remedy faults immediately.

The transition of the valve into standby or into fail-safe state can also be triggered by appropriate signals on the enable input of the valve connector X1:

- Signals between 8.5 V and 32 V based on GND at the enable input switch the valve to standby.
- Signals lower than 6.5 V at the enable input switch the valve to fail-safe state in the mechanical or electrical fail-safe state depending on the model (only for p or Q valves).

⇒ [Chap. "3.4.3 Digital enable input", page 48](#)



High pressure peaks in the hydraulic system can result in a drift of the valve's internal pressure transducer.

To monitor any possible drift of the valve's pressure transducer, we recommend that the pressure transducer be checked 3, 6 and 12 months after the valve is started up and thereafter at intervals of 6 months. This can be conducted for example using comparison measurements with a calibrated pressure gauge. If necessary, the internal pressure transducer must be recalibrated.

The pressure transducer can be influenced by means of parameters in the valve software. The parameters can be set or interrogated via the service or field bus interface in the valve software. Setting and query can, for example, take place with the Moog Valve and Pump Configuration Software.

**Monitoring the pressure  
transducer drift**

Information on maintenance:

⇒ [Chap. "10.2 Maintenance", page 156](#)

Information on correcting possible faults:

⇒ [Chap. "10.3 Trouble shooting", page 158](#)

## 9.3 Shutting down the valve

### DANGER



#### **Danger to life!**

Hydraulic pressure and electrical supply voltage are still normally applied after the valve has been shut down. The machine is not automatically put out of operation when the valve is shut down.

**Safety notes: Shutting down the valve**

### DANGER



#### **Danger of poisoning and injury due to hydraulic fluid squirting out under pressure!**

Contact with hydraulic fluids can damage your health (e.g. eye injuries, skin and tissue damage, poisoning in case of inhaling).

- ▶ Wear protective gloves and safety glasses.
- ▶ If hydraulic fluid gets into your eyes or on your skin, consult a doctor immediately.
- ▶ When handling hydraulic fluids, observe the safety provisions applicable to the hydraulic fluid used.

### DANGER



#### **Danger of injury due to electric voltage and unexpected movements!**

Work on machines that are not shut down presents a danger to life and limb. Work such as mounting or removal, electrical or hydraulic connection, troubleshooting or service may only be performed on machines and valves that are shut down.

- ▶ Make sure to shut the machine down and switch it off.
- ▶ Make sure that the drive motor cannot be switched on.
- ▶ For this purpose, switch off the supply voltage as well as that of connected peripherals, such as externally powered transducers or programming units.
- ▶ Make sure that all power-transmitting components and connections (electrical and hydraulic) are switched off according to the manufacturer's instructions and secured against switching on again. If possible, remove the main fuse from the machine.
- ▶ Make sure that the machine is completely depressurized.



The valve can be shut down as follows:

- Switching off of the supply voltage
- Adoption by the valve of the 'DISABLED' and 'INIT' valve states
- Signal at the enable input of valve connector X1

⇒ [Chap. "3.2.3 Fail-safe events", page 27](#)

If necessary, the valve must be restarted after it has been shut down or has entered the fail-safe state.

⇒ [Chap. "3.2.4 Restarting the valve", page 30](#)

### Shutting down the valve

# 10 Service

Safety notes: Service

## DANGER



### Danger to life!

Operating machines with damaged or defective components or with a leaking hydraulic system is dangerous and not permitted.

- ▶ Before starting up or operating the valve, check the higher-level machine including all its installed components for damage and defects.
- ▶ Pay particular attention here to higher-level and hydraulic safety devices such as, for example, EMERGENCY STOP switches and pressure-limiting valves.
- ▶ Report damage or defects to the relevant department immediately. If necessary, stop the machine immediately and secure it.
- ▶ Rectify any leaks immediately in accordance with this user manual, paying particular attention to the notes/instructions on handling in accordance with safety requirements.
- ▶ ⇒ Chap. "2.1 Handling in accordance with safety requirements", page 14
- ▶ ⇒ Chap. "10.3 Trouble shooting", page 158

## DANGER



### Danger of explosion!

To guarantee safe operation in hazardous areas:

- ▶ The signal interfaces of the valve are implemented with explosion-proof connectors.
- ▶ For mounting and removal of the plug connectors as well as operation of the valve, the notes and instructions in the "Explosion-proof connectors eXLink, CEAG" operating instructions must absolutely be adhered to.
- ▶ The eXLink operating instructions from CEAG are in the Appendix to this user manual.

## DANGER



### Danger of poisoning and injury due to hydraulic fluid squirting out under pressure!

Contact with hydraulic fluids can damage your health (e.g. eye injuries, skin and tissue damage, poisoning in case of inhaling).

- ▶ Wear protective gloves and safety glasses.
- ▶ If hydraulic fluid gets into your eyes or on your skin, consult a doctor immediately.
- ▶ When handling hydraulic fluids, observe the safety provisions applicable to the hydraulic fluid used.

**DANGER****Danger of explosion due to impermissible heating up of the valve!**

As a result of insufficient ventilation of the valve or deposits on the valve, the impermissible heating up of the valve can be such that the maximum temperatures of the certified temperature classes are exceeded.

- ▶ The valves must be checked regularly, cleaned if necessary. Deposits on the valve must be removed.
- ▶ If necessary inform the responsible person immediately and remove the valve from electrical and hydraulic operation.

**DANGER****Danger of injury due to electric voltage and unexpected movements!**

Work on machines that are not shut down presents a danger to life and limb. Work such as mounting or removal, electrical or hydraulic connection, troubleshooting or service may only be performed on machines and valves that are shut down.

- ▶ Make sure to shut the machine down and switch it off.
- ▶ Make sure that the drive motor cannot be switched on.
- ▶ For this purpose, switch off the supply voltage as well as that of connected peripherals, such as externally powered transducers or programming units.
- ▶ Make sure that all power-transmitting components and connections (electrical and hydraulic) are switched off according to the manufacturer's instructions and secured against switching on again. If possible, remove the main fuse from the machine.
- ▶ Make sure that the machine is completely depressurized.

**DANGER****Danger of explosion!**

To guarantee safe operation in hazardous area:

- ▶ In its standard model with screw plug, the service connector X10 is not permitted for use in hazardous area.
- ▶ For mounting of the screw plug of the service connector X10, it must be observed that the gasket and the threads of the screw plug as well as the threads in the electronic housing of the valve are not damaged.
- ▶ In case of damage to the screw plug of the service connector or the threads in the electronic housing, the valve must not be operated in an hazardous area.
- ▶ Tightening torque screw plug:  
⇒ [Chap. "3.1.2 Representative depiction of the valve", page 18](#)

**DANGER****Danger of explosion!**

The unsafe operation of the valves is dangerous.

- ▶ Only operate the valve when it is in a safe and functional state.
- ▶ At least once per shift, check valve for damage visible from the outside and defects such as leakage or damaged cables or connectors.
- ▶ Report changes, including to the operating behavior, damage, and defects to the responsible department immediately. If necessary, stop the machine immediately and secure it.
- ▶ ⇨ [Chap. "2.1 Handling in accordance with safety requirements", page 14](#)
- ▶ ⇨ [Chap. "10.3 Trouble shooting", page 158](#)

**WARNING****Risk of injury!**

To provide protection against injuries or other damaging influences on health, suitable protective measures must be taken if necessary prior to and when carrying out any work on the valves or the machine, such as mounting or removing, electrical or hydraulic connection, trouble shooting or servicing, and when handling the valves, accessories, tools or hydraulic fluids.

- ▶ ⇨ [Chap. "2.2 Occupational safety and health", page 15](#)

**WARNING****Danger of explosion!**

During shut-down, cables on the valve, cable glands, screw plugs, and connectors must not be damaged.

- ▶ The valve must not be started up with damaged cables, connectors, and screw plugs, and it must be sent to us or to one of our authorized service centers immediately.

**CAUTION****Danger of personal and property damage due to defective accessories and defective spare parts!**

Unsuitable or defective accessories or unsuitable or defective spare parts may cause damage, malfunctions or failure of the valve or the machine.

- ▶ Use only original accessories and original spare parts.
- ▶ ⇨ [Chap. "12 Accessories and spare parts", page 173](#)
- ▶ Warranty and liability claims for personal injury and damage to property are among other things excluded if they are caused by the use of unsuitable or defective accessories or unsuitable or defective spare parts.
- ▶ ⇨ [Chap. "1.8 Warranty and liability", page 11](#)

**CAUTION****Risk of damage!**

The plugs, connectors, and connection cables of the valves may not be used for other purposes, such as for stepping on or as transport holders.

## CAUTION

### **Danger of personal injury and damage to property!**

Working with and on the valves without the required basic mechanical, hydraulic, and electrical knowledge may cause injuries or parts may be damaged.

- ▶ Only properly qualified and authorized users may work with and on the valves.
  - ▶ ⇒ [Chap. "1.4 Selection and qualification of personnel"](#), page 7.
- 

## CAUTION

### **Risk of damage!**

In order to prevent damage to the valves or to the accessories:

- ▶ Due to the complexity of the internal components of the valves and of accessories, only we or our authorized service centers may make repairs and perform maintenance work other than that explained in this user manual.
  - ▶ The plugs, connectors, and connection cables of the valves may not be used for other purposes, such as for stepping on or as transport holders.
  - ▶ Warranty and liability claims for personal injury and damage to property are excluded among other things if they are caused by unauthorized repairs or other unauthorized interventions.
  - ▶ Structural changes to or opening of explosion-proof valves are not permitted since these invalidate the ex certification.
  - ▶ ⇒ [Chap. "1.8 Warranty and liability"](#), page 11
-

## 10.1 Removing of the valves

### 10.1.1 Tools and materials required

The following tools and materials are required for removing the valves:

- For removing and mounting the valve  
Torque wrench for 5 WAF hexagon socket screws
- Replacement for O-rings of ports to be replaced if necessary
- Shipping plate and associated fastening elements
- For mounting the shipping plate  
Regular screwdriver 8x1.6 [mm] and if necessary wrench WS 10

**Tools and materials  
required for removal**

#### CAUTION



#### **Danger of personal injury and damage to property!**

Failure to heed the eXLink operating instructions from CEAG can cause bodily injuries and property damage.

- ▶ Follow the eXLink operating instructions from CEAG in the Appendix to this user manual.
- ▶ Handle all ex-proof connectors according to the notes and instructions in the eXLink operating instructions from CEAG



The installation screws and the O-rings to be replaced if necessary are not included in the scope of delivery for the valves. They are available as an accessory.

⇒ [Chap. "12 Accessories and spare parts", page 173](#)

## 10.1.2 Removing

### CAUTION

#### Risk of damage due to dirt and moisture!

This is the only way of adequately protecting the valves against the penetration of dirt and moisture and protecting the gaskets/seals against the effects of ozone and UV.

- ▶ The valves must not be transported or stored without their shipping plate fitted.
- ▶ The valve shipping plate may only be removed from the valve hydraulic ports directly prior to mounting and must be reinstalled directly after the valve has been removed.
- ▶ The shipping plate and the associated fastening elements (screws and nuts) must be kept for later use, e.g. during transportation.

**Safety notes: Removing the valves**

#### Procedure:

1. Shut down and switch off the machine and place in a de-energized and depressurized state.



For the removal of the ex-protected connectors, the notes and instructions for the eXLink operating instructions of CEAG must be heeded.

The eXLink operating instructions from CEAG are in the Appendix to this user manual.

2. Disconnect the Ex-protected connectors.
3. Release the valve's installation screws.
4. Remove the valve from the mounting surface.
5. Check that O-rings in the valve ports (A, B, P, T, etc.) are present and for elasticity, integrity and correct seating.
6. Replace hardened and damaged O-rings with new O-rings.
7. Mount the shipping plate on the valve's hydraulic connection.  
Tightening torque of the attachment screws: approx. 5 Nm / 3.7 lbf ft (hand-tight)
8. If the valve is not to be immediately reused or is to be serviced: keep valve in original packaging.  
⇒ [Chap. "5 Transportation and Storage", page 58](#)
9. If necessary, seal the ports of the hydraulic system to prevent the hydraulic fluid from being contaminated.

**Procedure for removing the valve**

## 10.2 Maintenance

Changes in temperature, effects of the hydraulic fluid, such as, for example, pressure peaks, and similar influences can, depending on the application, expose the sealing materials to different levels of wear. This may, in turn, cause leaks.

In order to avoid possible resulting impairments or damage, we recommend that the valve, after a period of storage or operation of more than 5 years, be inspected by us or one of our authorized service centers.

**Embrittlement of the gasket materials**

**WARNING****Risk of damage!**

To guarantee safe operation in hazardous area.

- ▶ Maintenance work on ex-protected valves may only be performed by us or our authorized service centers.
- ▶ With the intervention of third parties, the ex certification becomes invalid.



If the valve is exposed to high loads, it may be necessary to reduce the check/inspection interval to suit the application.

**10.2.1 Checking and replacing the port O-rings****10.2.1.1 Tools and materials required**

The following are required for checking and replacing the port O-rings:

- For removing and mounting the valve  
Torque wrench for 5 WAF hexagon socket screws
- Replacement for O-rings of ports to be replaced if necessary  
⇒ [Chap. "12.2 Spare parts", page 175](#)

**Tools and materials  
required for checking and  
replacing the O-rings**

**10.2.1.2 checking and replacing the O-rings****Procedure:**

1. Remove the valve.  
⇒ [Chap. "10.1 Removing of the valves", page 155](#)
2. Check that O-rings in the valve ports (A, B, P, T, etc.) are present and for elasticity, integrity and correct seating.
3. Replace hardened and damaged O-rings with new O-rings.
4. Remount the valve.  
⇒ [Chap. "6.3 Mounting the valve", page 65](#)

**Procedure for checking  
and replacing the O-rings**



## 10.2.2 Monitoring the pressure transducer drift



High pressure peaks in the hydraulic system can result in a drift of the valve's internal pressure transducer.

To monitor any possible drift of the valve's pressure transducer, we recommend that the pressure transducer be checked 3, 6 and 12 months after the valve is started up and thereafter at intervals of 6 months. This can be conducted for example using comparison measurements with a calibrated pressure gauge. If necessary, the internal pressure transducer must be recalibrated.

The pressure transducer can be influenced by means of parameters in the valve software. The parameters can be set or interrogated via the service or field bus interface in the valve software. Setting and query can, for example, take place with the Moog Valve and Pump Configuration Software.

### Monitoring the pressure transducer drift

## 10.3 Trouble shooting

The following faults may occur:

- Leak at the valve connecting surface  
⇒ Chap. "10.3.1.1 Leak at the valve connecting surface", page 159
- leak at the linear force motor screw plug  
⇒ Chap. "10.3.1.2 Leak at the linear force motor screw plug", page 159
- leak at the venting screw  
⇒ Chap. "10.3.1.3 Leak at the venting screw", page 159
- No hydraulic response by the valve  
⇒ Chap. "10.3.2 No hydraulic response by the valve", page 160
- Instability of the control loops  
⇒ Chap. "10.3.3 Instability of the external control loop", page 161  
⇒ Chap. "10.3.4 Instability of the internal valve control loops", page 161

### Possible faults



If the fault cannot be corrected by means of the measures set out below, please contact us or one of our authorized service centers.

After correcting the fault, if necessary reinstall and restart the valve.

- ⇒ Chap. "6.3 Mounting the valve", page 65
- ⇒ Chap. "3.2.4 Restarting the valve", page 30

### Restarting after correcting the fault

## 10.3.1 Leaks

### 10.3.1.1 Leak at the valve connecting surface

#### Measures:

- Check that O-rings in the valve ports (A, B, P, T, etc.) are present and for elasticity, integrity and correct seating.  
If necessary, install O-rings, replace or correct the seating.
- Check the valve's mounting and connecting surfaces, the valve and the hydraulic system for damage, contamination and evenness.
- Check installation screws for secure and correct seating.  
If necessary, tighten screws with torque wrench for hexagon socket head cap screws.

#### Leak at the valve connecting surface



The wrench sizes of the hexagon socket cap head screws for mounting are type series-specific.

Details about fastening screws and their tightening torque:

⇒ [Tab. 7, Seite 65](#)

### 10.3.1.2 Leak at the linear force motor screw plug

#### CAUTION

- ▶ In the event of a leak at the linear force motor screw plug, have the valve check by Moog or one of its authorized service centers.

### 10.3.1.3 Leak at the venting screw

#### Measures:

- Check that the sealing ring on the venting screw is present and for elasticity, integrity and correct seating.  
If necessary, install the sealing ring, replace or correct the seating.
- Check the venting screws for secure and correct seating.  
If necessary, tighten screws with torque wrench for hexagon socket head cap screws WS 5.  
Tightening torque of the venting screw: 6 Nm / 4.4 lbf ft.  
Higher tightening torques can result in the destruction of the sealing ring for the venting screw.
- Check the valve's mounting and connecting surfaces, the valve and the hydraulic system for damage, contamination and evenness.

#### Leak at the venting screw

## 10.3.2 No hydraulic response by the valve

### DANGER



#### Danger to life!

Touching electrically live parts can cause electric shock.

- ▶ Touching electrically live parts must therefore be avoided.

#### Measures:

- Check whether all the machine components, connections and ports conform to the specifications of the machine manufacturer and operator. To do so, on the valves compare the data on the nameplate with the specifications.
- Check whether the hydraulic installation is correct and whether all the hydraulic ports are correctly established.
- Check whether hydraulic pressure is present.
- Check whether the supply voltage is present.
- Check whether the connectors are correctly attached and non-corroded.
- Check whether there is a command signal failure or a faulty electric cable.
- Check whether the desired signals are applied at the connector, in particular at the enable input.
- Check whether the command signal is analog or applied via the field bus interface (depending on the model).
- Check whether the valve is in a fault state.  
If necessary, correct the fault and then cancel the fault via the field bus or reset the valve by switching the supply voltage off and then on again.

#### Typical fault causes:

- Supply voltage dips below 18 V  
⇒ [Chap. "11.5 Electrical data", page 171](#)
- Maximum permissible temperature exceeded  
⇒ [Chap. "11.2 General technical data", page 168](#)
- Control error (for example, due to the spool sticking, which can be caused for instance by contamination)
- No command signal (e.g., due to cable break)
- Check whether the enable signal is applied (only for Q valve). If there is no enable, the valve cannot be put in the 'ACTIVE' valve status.
- Check whether the configuration of the internal valve software is correct.

#### No hydraulic response by the valve

### 10.3.3 Instability of the external control loop

#### Measures:

- Check whether the external control loop is stable.  
If necessary, reduce control loop gain.
- Check whether the internal valve control loops are stable.  
⇒ [Chap. "10.3.4 Instability of the internal valve control loops", page 161](#)
- Check whether the controlled system was modified.

**Instability of the external control loop**

### 10.3.4 Instability of the internal valve control loops

#### 10.3.4.1 Flow control

#### Measures:

- Check whether the signal quality of the command signals is sufficient.
- Check whether the system pressure is stable.
- Check whether the quality and purity of the hydraulic fluid used conforms to the specifications of the manufacturer and the operator of the machine.
- Check whether the valve is operational.  
To do this, perform a comparison of the command/actual value signals.

**Instability of the internal valve control loops: flow function**

#### 10.3.4.2 Pressure control

#### Measures:

- Check whether the signal quality of the command signals is sufficient.
- Check whether the system pressure is stable.
- Vent the valve or the hydraulic system.  
⇒ [Chap. "8.5.1 Venting", page 142](#)
- Optimize the control loop gain of the pressure controller by adapting the parameters (P, I, D, etc.).  
⇒ [Chap. "3.3.5 Notes on the pressure controller control response \(D639K\)", page 38](#)
- Check whether the quality and purity of the hydraulic fluid used conforms to the specifications of the manufacturer and the operator of the machine.
- Check whether the valve is operational.  
To do so, switch to flow control (Q-control) via the integrated service or field bus interface and perform a comparison of the command and actual value signals.
- Check whether the pressure controlled system has been modified.
- Check whether the pressure in T is below the pressure to be controlled.

**Instability of the internal valve control loops: pressure function**

## 10.4 Repair

### CAUTION



#### **Danger of personal injury and damage to property!**

Repaired valves or replacement valves are, like new valves, delivered with the factory settings. In the event of a repair job for defective valves, we and our authorized service centers shall not accept liability for software and data installed by the customer.

- ▶ Check the valves for correct mechanical design and correct configuration before start-up.

### CAUTION



#### **Danger of personal injury and damage to property!**

By changing the configuration of the valves, the functionality of the valve can be changed so that it causes damage, malfunction or failure of the valve or machine.

- ▶ It is only permitted to alter the valve configuration during operation if this does not cause any dangerous states in the machine and in its surroundings.



Maintenance work by the user on explosion proof valves is not permitted. Intervention by third parties will invalidate the ex certification.

**Moog Global Support™** provides professional repair and corrective maintenance services on the highest level thanks to our experienced technicians. Our customer service and our professional expertise ensure that your systems will always remain in an optimal state. Here we offer the reliability that you can only expect from leading manufacturers with worldwide branch offices.

**Moog Global Support**

**MOOG Global Support  
Logo**



Fig. 65: MOOG Global Support Logo

**WARNING****Risk of damage!**

To guarantee safe operation in hazardous area.

- ▶ Maintenance work on ex-protected valves may only be performed by us or our authorized service centers.
- ▶ With the intervention of third parties, the ex certification becomes invalid.

Your advantages:

- Shorter downtimes, critical systems can be operated permanently with high performance
- Investment security thanks to reliability, adaptability, and guaranteed life span of our products
- Optimized corrective maintenance planning and system set-up
- Use of our flexible corrective maintenance program according to your service requirements

Our service offerings:

- Repair with original parts by trained technicians according to the latest Moog specifications
- Provision of original spare parts and products in order to avoid unplanned downtimes
- Flexible programs according to your needs for preventative corrective maintenance and set-up thanks to annual or multi-year contracts
- On-site service for start-up, set-up, and fault diagnosis
- Reliable service with equally good quantity worldwide

For additional information about **Moog Global Support™**, visit

<http://www.moog.com/industrial/service>

Maintenance work and repairs by users of Ex protection valves are not allowed. This is because with intervention by third parties, the Ex certification is invalidated!



In the event of a repair job for defective valves, we and our authorized service centers reserve the right to perform a repair or, after consultation, alternatively to supply replacement valves with an identical or compatible equipment specification.

## 11 Technical Data

### CAUTION

**Risk of damage!**

In order to prevent damage to the valves or to the machine, heed the following points:

- ▶ Values specified in the technical data must be adhered to.
- ▶ Values specified on the nameplate must be adhered to.
- ▶ ⇒ [Chap. "11 Technical Data", page 164](#)

---

### CAUTION

**Risk of damage!**

In order to prevent damage to the valves or to the machine heed the following points:

- ▶ Do not immerse the valves in liquids.
-

## 11.1 Nameplates

### Nameplate

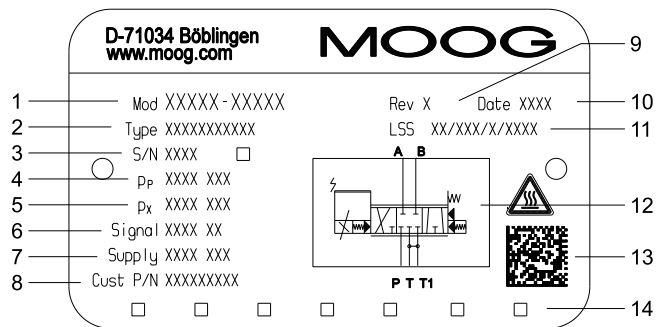

Item	Designation	Additional information
1	Model number	⇒ Chap. "11.1.1 Model number", page 167
2	Type designation	⇒ Chap. "1.2 Supplemental documents", page 5
3	Serial number	
4	Maximum operating pressure	⇒ Chap. "11.3 Hydraulic data", page 169
5	Not assigned	
6	Signal type for analog command inputs	⇒ Chap. "3.4.1 Signal types for analog command inputs", page 40
7	Power supply	Technical data: ⇒ Chap. "11.5 Electrical data", page 171 Pin assignment of connector X1: ⇒ Chap. "7.4.1 Pin assignment of connector X1", page 76
8	Optional customer-specific designation	
9	Optional version identification	
10	Date of manufacture in MM/YY format	
11	LSS address (decimal)	⇒ Chap. "11.1.2 LSS address (Layer Setting Services)", page 167
12	Hydraulic symbol	
13	Data matrix code	⇒ Chap. "11.1.3 Data matrix code", page 167
14	Designation of ports	⇒ Chap. "6.2.2 Mounting pattern of mounting surface", page 64

Fig. 66: Nameplate (example)



Ex nameplate

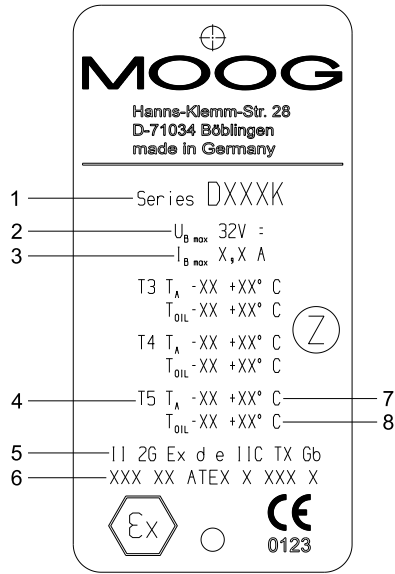

Item	Designation	Additional information
1	Series	
2	Power supply	
3	Current consumption	
4	Temperature class	T5
5	Identification	
6	Certification	
7	Ambient temperature	$T_A$ for temperature class from item 4
8	Fluid temperature	$T_{oil}$ for temperature class from item 4

Fig. 67: Ex nameplate (example)



The ambient and fluid temperatures may not exceed the values of the respective temperature classes.



The type designation and the signal type for analog command inputs on the nameplate indicate the valve's delivery status. The signal type can be set via the service or field bus interface in the valve software and therefore it is possible to change the valve in such a way that it no longer conforms to this status. Which signal type is currently set can be ascertained for example with the Moog Valve and Pump Configuration Software.

### 11.1.1 Model number

The model number is set out as follows:

**Model number**

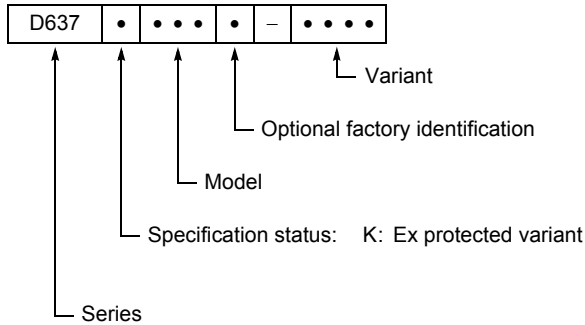

**Example:** D637K-1007-0001

### 11.1.2 LSS address (Layer Setting Services)

The decimal LSS address is set out in accordance with [CiA DSP 305](#) as follows and serves to provide the CAN bus node with an internationally unique identification:

**LSS address**

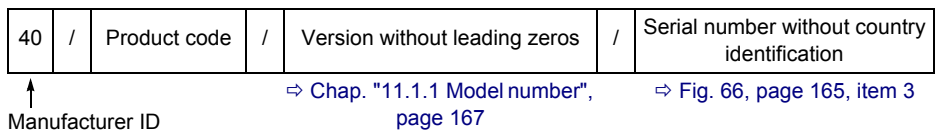

**Example:** 40/424/1/4321



Even valves without CAN bus interfaces are assigned a decimal LSS address during manufacturing.

### 11.1.3 Data matrix code

The data matrix code is a two-dimensional code. The code on the nameplate contains a character string that is set out as follows:

**Data matrix code**

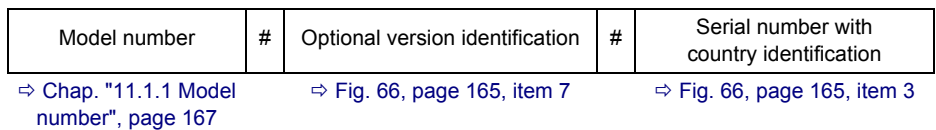

If there is no optional version identification, a blank space appears here.

**Example:** D637K 1007-0001#A#D4321

## 11.2 General technical data

### CAUTION

#### Risk of damage!

In order to prevent damage to the valves or to the machine heed the following points:

- ▶ Do not immerse the valves in liquids.

<b>Version</b>	servo valve		
<b>Dimensions</b>	⇒ Chap. "6.1 Dimensions (installation drawings)", page 63		
<b>Installation position</b>	In any position, fixed or moving; on valves with venting screws (D639K): venting screw must point upward  Observe the relevant safety instructions when mounting the valve. ⇒ Chap. "6 Mounting and Connection to the Hydraulic System", page 61		
<b>Permissible ambient conditions</b>	Ambient temperature <sup>1</sup>		
	For transportation/ storage	recom- mended	15 °C to 25 °C (59 to 77 °F) <sup>2</sup>
		permissi- ble	−40 °C to 80 °C <sup>2</sup>
	For operation	(−40 ° on request) −20 ° to 60 ° depending on the certified temperature classes	
	Rel. air humidity for storage	< 65 % not condensing	
	Vibration resistance <sup>3</sup>	10 g, 3 axes, frequency: 10 to 2,000 Hz (according to DIN EN 60068-2-6)	
Shock resistance <sup>3</sup>	50 g, 6 directions, half-sine 3 ms (according to DIN EN 60068-2-27)		

### General technical data

Tab. 24: General technical data

<sup>1</sup> The ambient temperature and the temperature of the hydraulic fluid influence the temperature of the valve electronics. In order to ensure that the electronic components integrated in the valve last as long as possible, we recommend that the hydraulic fluid be kept at as low a temperature as possible at as low an ambient temperature as possible. A reference temperature is measured in the valve electronics. Fault-free operation is guaranteed up to a reference temperature of 85 °C (185 °F). At reference temperatures over 85 °C (185 °F) a warning is output via the field bus on valves with field bus interfaces. At reference temperatures over 105 °C (221 °F) the valve electronics are deactivated; the valve adopts the 'DISABLED' valve status and thus the mechanical fail-safe state.  
⇒ Chap. "3.2 Safety function/fail-safe", page 24

<sup>2</sup> Temperature fluctuations > 10 °C must be avoided during storage.

<sup>3</sup> Transportation and storage should be as vibration- and shock-free as possible.

## 11.3 Hydraulic data



The cleanness of the hydraulic fluid greatly influences the functional safety (safe positioning of the spool, high resolution) and the wear (control land, pressure gain, leakage losses) of the valves. To avoid malfunctions and increased wear, we recommend that the hydraulic fluid be filtered accordingly.

<b>Valve construction type</b>	Gate valve, one-stage, with bushing D637K-R and D639K-R, spool in valve body D637K-P and D639K-P		
<b>Actuation/drive</b>	Directly with permanent magnet linear force motor		
<b>Control oil supply</b>	None		
<b>Nominal size and mounting pattern</b>	NG10, hole pattern according to ISO 4401-05-05-0-05, with or without leakage port Y ⇒ Chap. "3.3.3 Leakage port Y", page 36 ⇒ Chap. "6.2.2 Mounting pattern of mounting surface", page 64		
<b>Diameter of ports</b>	11.5 mm ⇒ Chap. "6.2.2 Mounting pattern of mounting surface", page 64		
<b>Gasket material</b>	NBR, FKM, others on request		
<b>Valve configurations</b>	2-way, 3-way, 4-way and 2x2-way operation ⇒ Chap. "3.3.2 Valve configurations and hydraulic symbols", page 35		
<b>Overlap</b>	Zero overlap, less than $\pm 3\%$ or $\pm 10\%$ positive overlap (model-dependent) zero overlap not for D637K-P/D639K-P		
<b>Max. flow <math>Q_{max}</math></b>	180 l/min (0.9 gpm) ⇒ Chap. "4.1 Flow diagram (4-way operation)", page 51		
<b>Rated flow <math>Q_N</math></b>	60/80/100 l/min (model-dependent) (for $\Delta p_N = 35$ bar per control edge: tolerance $\pm 10\%$ ), 80l/min for D63xK-P with leakage oil 3l/min		
<b>Max. leakage flow <math>Q_L^1</math></b>	1.2/2 l/min (model-dependent)		
<b>Maximum operating pressure</b>	Ports P and B	350 bar (5,075 psi)	
	Port A (for D637K)	350 bar (5,075 psi)	
	Port A (for D639K)	Dependent on pressure transducer, max. 350 bar (5,075 psi) ⇒ Chap. "11.3.1 Pressure range identification", page 170	
	Port T, $T_1$ without Y	50 bar (725 psi) ⇒ Chap. "3.3.3 Leakage port Y", page 36	
	Port T, $T_1$ with Y	350 bar (5,075 psi)	
	Port Y	Depressurized to tank	
<b>Linearity of pressure control (only for D639-R)</b>	< 0.5 % of the maximum operating pressure in port A ⇒ Chap. "11.3.1 Pressure range identification", page 170		
<b>Hydraulic fluid</b>	Permissible fluids	Mineral-oil-based hydraulic oil as per DIN 51524-1 to DIN 51524-3 Other fluids on request	
	Permissible temperature <sup>2</sup>	(-40 ° on request) -20 ° to 80 ° depending on the certified temperature classes	
	Viscosity $\nu$	recommended	15 to 100 mm <sup>2</sup> /s
		permissible	5 to 400 mm <sup>2</sup> /s
	Cleanliness level, recommended (ISO 4406)	for functional safety	< 18/15/12
for life cycle (wear)		< 17/14/11	

Tab. 25: Hydraulic data

<sup>1</sup> Typical values (measured at operating pressure  $p_p = 140$  bar, viscosity of the hydraulic fluid  $\nu = 32$  mm<sup>2</sup>/s and temperature of the hydraulic fluid  $T = 40$  °C)

<sup>2</sup> The ambient temperature and the temperature of the hydraulic fluid influence the temperature of the valve electronics. In order to ensure that the electronic components integrated in the valve last as long as possible, we recommend that the hydraulic fluid be kept at as low a temperature as possible at as low an ambient temperature as possible. A reference temperature is measured in the valve electronics. Fault-free operation is guaranteed up to a reference temperature of 85 °C (185 °F). At reference temperatures over 85 °C (185 °F) a warning is output via the field bus on valves with field bus interfaces. At reference temperatures over 105 °C (221 °F) the valve electronics are deactivated; the valve adopts the 'DISABLED' valve status and thus the mechanical fail-safe state.  
⇒ Chap. "3.2 Safety function/fail-safe", page 24

### 11.3.1 Pressure range identification

The pressure range identification, i.e. the 3rd position in the valve type designation, indicates what maximum operating pressure is permissible in port A. Type designation: ⇒ [Chap. "3.7 Nameplate", page 50](#)

#### Pressure range identification

Type designation:

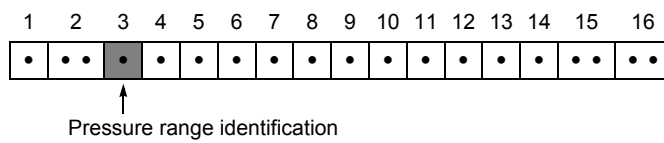

Ident.	Maximum operating pressure in port A	Series		
		D637K Q	D639K p    pQ	
W	25 bar (363 psi)		•	•
V	100 bar (1,450 psi)		•	•
U	160 bar (2,320 psi)		•	•
T	250 bar (3,625 psi)		•	•
K	350 bar (5,075 psi)	•	•	•
X	Special version		•	•

Tab. 26: Pressure range identification in the type designation

The pressure controlled with a pressure command of 100 % in port A can, depending on the application, deviate from the maximum operating pressure and be set by the customer.

### 11.4 Static and dynamic data

#### Static and dynamic data

<b>Step response time for 0 to 100 % spool stroke<sup>1</sup></b>	15 ms for D63xK-R 20 ms for D63xK-P (in the Q-function) ⇒ <a href="#">Chap. "4.4 Step response and frequency response", page 54</a>	
<b>Hysteresis<sup>1</sup></b>	in Q-control	< 0.05 %, max. 0.1 %
	in p-control	depending on controller optimization
<b>Zero shift (typical)</b>	< 1.5 % for $\Delta T = 55$ K (in the Q-function)	

Tab. 27: Static and dynamic data

<sup>1</sup> Typical values (measured at operating pressure  $p_P = 140$  bar, viscosity of the hydraulic fluid  $\nu = 32$  mm<sup>2</sup>/s and temperature of the hydraulic fluid  $T = 40$  °C)

## 11.5 Electrical data

### Electrical data

<b>Protection type</b>	IP65 with mounted mating connectors or with mounted dust protection caps with sealing function (as per EN 60529)	
<b>EMC protection requirements</b>	Immunity to interference as per EN 61000-6-2:2005 (evaluation criterion A) With SELV/PELV power supply (item number: D137-003-001): Immunity to interference as per EN 55011:2003 Emitted interference as per EN 61000-6-4:2005 (CAN bus and Profibus DP) or as per EN 61000-6-3:2005 (EtherCAT) ⇒ Chap. "11.5.1 Electromagnetic compatibility (EMC)", page 172	
<b>Supply voltage</b>	Nominal 24 V (18–32 V) DC based on GND. Only use SELV-/PELV power supply as per EN 60204-1 At supply voltages less than 18 V, the valve is rendered in the fail-safe state. ⇒ Chap. "3.2.3 Fail-safe events", page 27	
<b>External fuse protection for each valve</b>	3.15 A slow-blowing fuse	
<b>Duty cycle</b>	100 %	
<b>Valve connector X1</b>	7-pin connector with pin contacts ⇒ Chap. "7.4 Connector X1", page 76	
<b>Power consumption</b>	$P_{\min}$ (motor in neutral position)	9.6 W at $I = 0.4 \text{ A}$ <sup>1</sup>
	$P_{\max}$ (at max. flow)	67.2 W at $I_{\max} = 2.8 \text{ A}$ <sup>1</sup> (for valves with $Q_N = 60 \text{ l/min}$ )
		36 W at $I_{\max} = 2.5 \text{ A}$ <sup>1</sup> (for valves D637K-R and D639K-R with $Q_N = 100 \text{ l/min}$ )
<b>Inputs/outputs</b>	Command input 0–10 V	$R_{\text{in}} = 20 \text{ k}\Omega$
	Command input $\pm 10 \text{ V}$	$R_{\text{in}} = 20 \text{ k}\Omega$
	Command input 0–10 mA	$R_{\text{in}} = 200 \Omega$
	Command input $\pm 10 \text{ mA}$	$R_{\text{in}} = 200 \Omega$
	Command input 4–20 mA	$R_{\text{in}} = 200 \Omega$
	Actual value output 4–20 mA	$R_L = 0\text{--}500 \Omega$ to GND
	Enable input	Signals between 8.5 V and 32 V based on GND at the enable input switch the valve to standby. Signals lower than 6.5 V at the enable input switch the valve to fail-safe state in the mechanical or electrical fail-safe state depending on the model. ⇒ Chap. "3.4.3 Digital enable input", page 48

Tab. 28: Electrical data

<sup>1</sup> Power consumption  $I$  and  $I_{\max}$  measured at ambient temperature  $T_U = 25 \text{ }^\circ\text{C}$  and supply voltage  $U = 24 \text{ V DC}$

## 11.5.1 Electromagnetic compatibility (EMC)

The valves fulfill the EMC protective requirements for immunity to interference as per [EN 61000-6-2:2005](#) (assessment criterion A).

SELV/PELV power supply (item number: D137-003-001) as power supply fulfill the vales the protective requirements for immunity to interference as per [EN 55011:2003](#).

### Electromagnetic compatibility (EMC)



Only use SELV/PELV power supply!

The valves fulfill the EMC protective requirements for immunity to interference as per [EN 61000-6-4:2005](#) (CAN-bus and Profibus DP) and as per [EN 61000-6-3:2005](#) (EtherCAT).

The following technical requirements must be in place so that the EMC protection requirements can be satisfied:

- Use of the mating connectors recommended for the valves  
⇒ [Chap. "12.1 Accessories", page 173](#)
- Adequate shielding
- Execution of equipotential bonding system, protective grounding and electrical shielding as per "TN 353"

## 12 Accessories and spare parts

### CAUTION



#### Danger of personal and property damage due to defective accessories and defective spare parts!

Unsuitable or defective accessories or unsuitable or defective spare parts may cause damage, malfunctions or failure of the valve or the machine.

- ▶ Use only original accessories and original spare parts.
- ▶ ⇒ [Chap. "12 Accessories and spare parts", page 173](#)
- ▶ Warranty and liability claims for personal injury and damage to property are among other things excluded if they are caused by the use of unsuitable or defective accessories or unsuitable or defective spare parts.
- ▶ ⇒ [Chap. "1.8 Warranty and liability", page 11](#)

### 12.1 Accessories



The accessories are Not included in scope of delivery  
⇒ [Chap. "5.2 Scope of delivery of the valve", page 60](#)

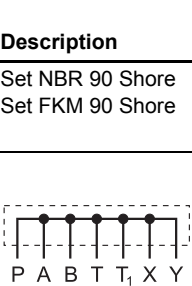
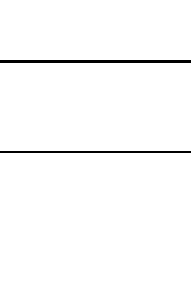
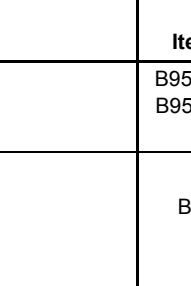

Cables of the connector cable that are not used must be insulated or insulated and placed in the control cabinet.

Item designation	Number required	Description	Item number
<b>Service sealing set</b> (contains all the O-rings for ports A, B, P, T, T <sub>1</sub> and Y and O-ring recess X)	1 1	Set NBR 90 Shore Set FKM 90 Shore	B95215-N681-10 B95215-V681-10
<b>Flushing plates</b> for ports P, A, B, T, T <sub>1</sub> , X, Y	1		B67728-001
for ports P, T, T <sub>1</sub> , and X, Y	1		B67728-002
for ports P, T, T <sub>1</sub> , X, Y	1		B67728-003
<b>Connecting plates</b>			on request
<b>Installation screws</b>	4	M6x40 (D637K-P/D639K-P) Hexagon socket head cap screw as per <a href="#">EN ISO 4762</a> , quality class: 10.9, tightening torque: 11 Nm ± 10 % / 8 lbf ft +/- 10 %	A03665-060-040
<b>Installation screws</b>	4	M6x60 (D637K-R/D639K-R) Hexagon socket head cap screw as per <a href="#">EN ISO 4762</a> , quality class: 10.9, tightening torque: 11 Nm ± 10 % / 8 lbf ft +/- 10 %	A03665-060-060

Tab. 29: Accessories (Part 1 of 3)



Item designation	Number required	Description	Item number
Adapter cable M8-M12, 2 m (not approved for hazardous area)	1		C40934-001
USB start-up module (for service connector X10 not approved for hazardous area)	1		C43094-001
Configuration/start-up cable, 2 m (not approved for hazardous area)	1		TD3999-137
SELV/PELV power supply (24 V DC voltage, 10 A not approved for hazardous area)	1		D137-003-001
Power supply cord, 2 m (not approved for hazardous area)	1		B95924-002
Moog Valve and Pump Configuration Software	1		on request
<b>Supplementing documents</b>			
Manual: "Moog Valve and Pump Configuration Software", German			on request
Manual: "Moog Valve and Pump Configuration Software", English			on request
TN 4904	1	Permissible lengths for electrical connection lines from valves with integrated electronics	CA48851
TN 353	1	Potential equalization and protective ground- ing for hydraulic valves with integrated elec- tronics	CA58437
TN 502	1	Valves with EtherCAT interface	CA566678
User manual for Digital Interface Valves with EtherCAT Interface	1	Valves with EtherCAT interface	CDS33722-en
Firmware B9926-DV013-B-211			
 Documents can be found and downloaded by specifying the item number: German-language documents a <a href="http://www.moog.de/german/about-moog-inc/industrial-group-literature-library/">http://www.moog.de/german/about-moog-inc/industrial-group-literature-library/</a> English-language documents at <a href="http://www.moog.com/industrial/literature">http://www.moog.com/industrial/literature</a>			
<b>Mating connector X1</b>	1	Without cable, plug exlink, Fa. CEAG	CB22154-001
<b>Mating connector X2</b>	1	Without cable, plug exlink, Fa. CEAG	CB22150-001
<b>Mating connector CAN X3, X4</b>	2	Without cable, plug exlink, Fa. CEAG	CB22142-001
<b>Mating connector Profibus X3, X4</b>	2	Without cable, plug exlink, Fa. CEAG	CB22145-001
<b>Mating connector Ethercat X3, X4</b>	2	Without cable, plug exlink, Fa. CEAG	CB22152-001
<b>Mating connector X5, X6, X7</b>	3	Without cable, plug exlink, Fa. CEAG	CB22148-001
<b>Connection cable X1</b>	1	Mud-resistant cable with plug exlink, Fa. CEAG, cable length 20 m	CB22155-001
<b>Connection cable X2</b>	1	Mud-resistant cable with plug exlink, Fa. CEAG, cable length 20 m	CB22151-001
<b>Connection cable CAN X3, X4</b>	2	Mud-resistant cable with plug exlink, Fa. CEAG, cable length 20 m	CB22346-001
<b>Connection cable CAN X3, X4</b>	1	Mud-resistant cable with plug exlink, Fa. CEAG, cable length 20 m With integrated terminal resistor - this cable can only be used to connect the last valve in the field bus chain	CB22144-001

Tab. 29: Accessories (Part 2 of 3)

Item designation	Number required	Description	Item number
Connection cable CAN X3, X4	2	Mud-resistant cable with plug exlink, Fa. CEAG, cable length 20 m This cable must be used if 24 V supply should be looped over the CAN bus. The terminal resistor must be effected externally	CB22143-001
Connection cable Profibus X3, X4	2	Mud-resistant cable with plug exlink, Fa. CEAG, cable length 20 m	CB22146-001
Connection cable Profibus X3, X4	1	Mud-resistant cable with plug exlink, Fa. CEAG, cable length 20 m With integrated terminal resistor - this cable can only be used to connect the last valve in the field bus chain	CB22147-001
Connection cable Ethercat X3, X4	2	Mud-resistant cable with plug exlink, Fa. CEAG, cable length 20 m	CB22153-001
Connection cable X5, X6, X7	3	Mud-resistant cable with plug exlink, Fa. CEAG, cable length 20 m	CB22149-001

Tab. 29: Accessories (Part 3 of 3)



The PDF files of the supplementing documents can be downloaded from the following link:

<http://www.moog.com/industrial/literature>

## 12.2 Spare parts

Item designation	Number required	Description	Item number
<b>O-rings</b>			
for ports A, B, P, T and T <sub>1</sub>	5	ID 12.4 x dia. 1.8 NBR 90 Shore [mm] (0.49 x 0.07 in) FKM 90 Shore	-45122-004 -42082-004
for port Y and O-ring recess X	2	ID 15.6 x dia. 1.8 NBR 90 Shore [mm] (0.61 x 0.07 in) FKM 90 Shore	-45122-011 -42082-011
<b>Sealing ring for venting screw</b>	1	Required only for D639K  HNBR FKM	B97018-060-003 B97018-060-002
<b>Shipping plate</b>	1		A40508
<b>Fastening elements for shipping plate</b>		Do not use to mount the valve	
Attachment screws	4	M6x55, slotted fillister head screw, tightening torque: approx. 5 Nm / 3.7 lbf ft (hand-tight)	-66119-060-055
Fastening nuts	4	M6, hexagon nut	-66118-060

Tab. 30: Spare parts

## 12.3 Tools for valves in the D637K and D639K type series

Item designation	Comments	Item number
<b>Tools for the mating connectors of the valve connectors</b>	Crimping tool for mating connector	see operating instructions eXLink, CEAG

Tab. 31: Spare parts for valves in the D67XK type series

# 13 Ordering Information

**D637 / D639** K . . . . . - . . . . .



Model designation
Factory identification
Variant

1	Valve type
R	Servo valve with integrated digital electronics, spool in bushing design
P	Proportional valve with integrated digital electronics, spool in valve body design

2	Nominal flow rate valve type - P/R		
	$Q_N$ [l/min] at $\Delta p_N = 35$ bar	$\Delta p_N = 5$ bar per control land	Series
24	60	24	D63xK - P/D63xK - R
40	100	40	D63xK - P/D63xK - R
60	160	60	D63xK - P

3	Pressure ranges in bar
	Maximum operating pressure
K	350 bar

4	Bushing / spool design
0	4-way: Zero overlap, linear characteristic curve
A	4-way: 1.5 to 3 % positive overlap, linear characteristic curve
D	4-way: 10 % positive overlap, kinked characteristic curve
Z	2x2-way: P → A, B → T, only with Y connection
X	Special spool, on request

5	Linear force motor	Series
2	Standard	D637K-R / D639K-R
6	high flow	D637K-P / D639K-P

6	Spool position without supply voltage
M	Mid position <sup>1)</sup>
F	P → A, B → T connected (10% open)
D	P → A, B → T connected (10% open)

<sup>1)</sup> This does not correspond with bushing/spool design O, A to the hydraulic mid position

<sup>2)</sup> Only in connection with field bus connectors "G, H, J" (switch to analog signals "M, X, E" possible)

<sup>3)</sup> Valve parameterization with start-up software "Moog Valve Configurator" via M8 service connector

<sup>4)</sup> Only in connection with field bus connector "G"

<sup>5)</sup> Only in connection with field bus connectors "H, J, O" for use in areas subject to explosion

<sup>6)</sup> Only in connection with field bus connector "J"

## 13 Ordering Information

7	8	9	10	11	12	13	14	15	16
16 Valve functionality									
A1 Q-control									
B1 p-control									
C1 pQ-control									
15 Service connector X10									
J3 Unclassified <sup>4)</sup>									
H3 With <sup>5)</sup>									
14 Field bus connector X3, X4									
G CAN									
H Profibus DP <sup>3)</sup>									
J EtherCAT <sup>3)</sup>									
O Unclassified <sup>3)</sup>									
13 Enable function									
A When the enable signal is deactivated the spool takes up a controlled neutral position that can be set at the factory.									
B Linear force motor without enable signal de-energized.									
K <sup>6)</sup> When the enable signal is deactivated the spool takes up a settable controlled neutral position.									
L <sup>6)</sup> Linear force motor without enable de-energized.									
Others on request									
12 Valve design									
D639K		N Flow control with pressure limitation control upwards							
D637K		M Pressure control in the main flow							
		- .....							
11 Electrical supply									
2		24 V DC (18 to 32 V DC)							
10 Signals for flow Q and pressure p									
		Input signal      Measurement output p							
M		±10 V      4 to 20 mA							
X		±10 mA      4 to 20 mA							
E		4 to 20 mA      4 to 20 mA							
9		Field bus digital <sup>2)</sup>							
		Actual value output							
		Spool position 4 to 20 mA							
9 Valve connector X1									
J		7-pin							
8 Gasket material									
N		HNBR							
V		FKM							
A		T-ECOPUR (-40° C)							
B		FKM44 (-40° C)							
		Others on request							
7 Y port									
0		Closed, with screw plug				P <sub>Tmax</sub> = 50 bar			
3		Open, with filter element				P <sub>T</sub> > 50 bar			

<sup>1)</sup> This does not correspond with bushing/spool design O, A to the hydraulic mid position

<sup>2)</sup> Only in connection with field bus connectors "G, H, J" (switch to analog signals "M, X, E" possible)

<sup>3)</sup> Valve programming with start-up software "Moog Valve Configurator" via M8 service connector

<sup>4)</sup> Only in connection with field bus connector "G"

<sup>5)</sup> Only in connection with field bus connectors "H, J, O" for use in areas subject to explosion

<sup>6)</sup> Only in connection with field bus connector "J"

**A B C D E F G H I J K L M N O P Q R S T U V W X Y Z**

## 14 Keyword index

### 2/2-way seat valve

connector X9 in the block diagram of the valve/pump electronics • 73

## A

### Abbreviations

list of abbreviations • 190  
 A/D (analog-digital converter)  
 ACV (Axis Control Valve, valve with axis control functionality)  
 CAN (Controller Area Network)  
 CiA (CAN in Automation e. V.)  
 D/A (digital-analog converter)  
 DDV (Direct Drive Valve)  
 DIN (Deutsches Institut für Normung e. V.)  
 DSP (Draft Standard Proposal)  
 EMC (electromagnetic compatibility)  
 EN (European standard)  
 ESD (Electrostatic Discharge)  
 EU (European Union)  
 FKM (fluorocarbon rubber, material for gaskets, such as O-rings)  
 GND (Ground)  
 ID (Identifier)  
 ID (Inner Diameter, e.g. of O-rings)  
 IEC (International Electrotechnical Commission)  
 IP (International Protection)  
 ISM (industrial, scientific and medical, e.g. for ISM devices)  
 ISO (International Organization for Standardization)  
 LED (Light Emitting Diode)  
 LSS (Layer Setting Services)  
 LVDT (Linear Variable Differential Transformer)  
 NBR (Nitrile Butadiene Rubber, material for gaskets, such as O-rings)  
 NG (nominal size of the valve)  
 PC (Personal Computer)  
 PE (Protective Earth)  
 PELV (Protective Extra Low Voltage)  
 PID (Proportional Integral Differential, e. g. in PID controller)  
 PWM (Pulse Width Modulation)  
 SELV (Safety Extra Low Voltage)  
 SW (Width Across Flats for wrenches)  
 TN (Technical Note)  
 TÜV (Technischer Überwachungsverein)  
 USB (Universal Serial Bus)  
 UV (Ultraviolet)  
 VDE (Verband der Elektrotechnik Elektronik Informationstechnik e. V.)  
 VDI (Verein Deutscher Ingenieure e. V.)

**Accessories**, ordering information • 173

**Acronyms** • 190

**Activation** • 22, 39

**ACV** (Axis Control Valve)

Analog input connectors X5...X7  
 in the representative depiction of the valve • 18  
 Connector X2 for digital signal interface  
 in the representative depiction of the valve • 18

**adapter for service connector X10** • 139

**Air humidity**, permissible relative air humidity for storage • 168

**Allocation of interfaces to connectors** • 75

### Ambient conditions

permissible ambient conditions • 168  
 potentially explosive environment • 168

**Ambient temperature**, permissible ambient temperature • 168

**Armature of the linear force motor**, in the representative depiction • 19

**Attachment screws** for the shipping plate • 66, 156

fastening nuts, ordering information • 175  
 in the installation drawing of the valve • 63  
 ordering information • 175  
 position of bores F<sub>1</sub>...F<sub>4</sub> in the mounting surface mounting pattern • 64  
 tightening torque • 156  
 width across flats • 65, 155

## B

**Block diagram of the valve/pump electronics** • 73

### Block diagrams

flow and pressure control (pQ-control) • 34  
 flow control (Q-control) • 32  
 pressure control (p-control) • 33

**Bushing** in the representative depiction of the valve • 18

**Bushing-spool identification** in the type designation • 26

## C

### C<sub>typ</sub>

typical capacitance • 105

### Cables

cable length in CAN networks • 116  
 cable length in Profibus-DP networks • 119  
 cable routing inside machines • 105  
 calculation  
 maximum length • 106  
 typical capacitance C<sub>typ</sub> • 105  
 typical resistance R<sub>typ</sub> • 105  
 voltage drop per unit length • 107  
 dimensioning • 105  
 permissible lengths • 105–109  
 pin assignment of the cables for EtherCAT networks • 122  
 requirements • 101  
 suitable cables for  
 CAN networks • 116  
 EtherCAT networks • 122  
 Profibus-DP networks • 120

### cAN bus

general information • 84  
 pin assignment • 85  
 Technical data • 84

**CAN** (Controller Area Network)

CAN bus interface • 50, 63  
 literature, additional, CAN fundamentals • 192

**A B C D E F G H I J K L M N O P Q R S T U V W X Y Z**

**A B C D E F G H I J K L M N O P Q R S T U V W X Y Z**

**CAN networks**

- cable cross section • 116
- cable length • 116
- interference immunity • 114
- module address • 117
- number of bus nodes • 117
- suitable cables • 116
- transmission rate • 117
- Wiring • 113–117
  - Procedure • 113
- wiring diagram • 114

**Cavitation • 51**

**CE labeling of the M3000® modules • A**

**Centering springs of the linear force motor**

- in the representative depiction • 19

**Characteristic curves**

- flow diagram • 51
- flow signal characteristic curve • 37, 52
  - design for measurement • 52
  - hydraulic zero position • 37
- frequency response of the spool stroke • 54
- Pressure characteristic curve • 52
  - design for measurement • 52
  - step response of the spool stroke • 54

**characteristic curves • 51–56**

**Checking/unpacking a delivery • 60**

**Cleaning**

- disposal of auxiliary materials and substances used • 9

**cleaning**

- cleaning connecting and mounting surfaces • 67

**Cleanliness level of the hydraulic fluid • 142, 169**

**Clock pulse output (signal of SSI transducer) • 83**

**Command signal U<sub>Command</sub> of input voltage • 111**

**Command signals, single-ended • 110**

**configuration of the valves • 49, 136**

- configuration via the field bus interface • 137
- configuration via the service interface • 139
- factory setting of the valves • 140

**Configuration/start-up cable • 139**

- ordering information • 174

**Connecting plates • 173**

**Connecting surface**

- cleaning • 67
- trouble shooting in event of a leak • 159

**Connection of the valve**

- hydraulic connection • 61, 66–67

**Connector**

- Connector X1 • 22
    - in the connector overview • 74
  - field bus connectors X3 and X4
    - in the connector overview • 74
  - in the block diagram of the valve/pump electronics • 73
  - list of interfaces • 75
  - overview (arrangement of connectors on the valve electronics housing) • 74
  - service connector X10
    - in the connector overview • 74
  - X1 (valve connector) • 39, 171
    - in the representative depiction of the valve • 18
  - X1 (connector)
    - in the block diagram of the valve/pump electronics • 73
    - pin assignment • 76
  - X2 (connector X2 for digital signal interface)
    - in the representative depiction of the valve • 18
  - X2 (digital signal interface)
    - in the block diagram of the valve/pump electronics • 73
  - X3 and X4 (field bus connectors)
    - dust protection caps • 135, 147
    - in the block diagram of the valve/pump electronics • 73
    - in the representative depiction of the valve • 18
  - X5...X7 (analog input connectors)
    - in the block diagram of the valve/pump electronics • 73
    - in the representative depiction of the valve • 18
  - X8 (external LVDT connector)
    - in the block diagram of the valve/pump electronics • 73
  - X9 (2/2-way seat valve connector)
    - in the block diagram of the valve/pump electronics • 73
  - X10 (service connector)
    - in the block diagram of the valve/pump electronics • 73
    - 139
      - adapter • 139
      - dust protection cap • 135, 147
      - in the representative depiction of the valve • 18
  - X11 (pilot valve connector)
    - in the block diagram of the valve/pump electronics • 73
- Connectors X3 and X4**
- in the block diagram of the valve/pump electronics • 73
  - pin assignment • 85, 87, 89
  - wiring CAN networks • 113–117
    - cable length and cable cross section • 116
    - interference immunity • 114
    - Procedure • 113
    - wiring diagram • 114
  - wiring EtherCAT networks • 121–123
    - Procedure • 121
    - wiring diagram • 122
  - wiring Profibus-DP networks • 118–120
    - cable length and cable cross section • 119
    - Procedure • 118
    - wiring diagram • 119
- Connectors X5...X7**
- in the block diagram of the valve/pump electronics • 73
  - pin assignment • 90
- Connector X1 • 76**
- in the block diagram of the valve/pump electronics • 73
  - pin assignment • 76
    - 6+PE-pin connector • 76
  - versions • 76
  - Wiring
    - 6+PE-pin connector • 110
    - 11+PE-pin connector • 110

**A B C D E F G H I J K L M N O P Q R S T U V W X Y Z**

**A B C D E F G H I J K L M N O P Q R S T U V W X Y Z**

**Connector X2**

- in the block diagram of the valve/pump electronics • 73
- pin assignment • 83
- wiring CAN networks • 113–117
  - cable length and cable cross section • 116
  - interference immunity • 114
  - Procedure • 113
  - wiring diagram • 114
- wiring SSI transducers • 112

**Connector X8**

- in the block diagram of the valve/pump electronics • 73

**Connector X9**

- in the block diagram of the valve/pump electronics • 73

**Connector overview**, arrangement of connectors on the valve electronics housing • 74**Connector X1** • 22

- in the connector overview • 74

**Connector X10**

- in the block diagram of the valve/pump electronics • 73
- pin assignment • 93

**Connector X11** • 93

- in the block diagram of the valve/pump electronics • 73
- pin assignment • 93

**Control loops**

- trouble shooting in event of instabilities
  - instability of the external control loop • 161
  - instability of the internal valve control loops • 161

**Control oil supply** • 169**Conversion of actual value output signals  $I_{out}$  (4–20 mA) into 2–10 V** • 111**copyright**

- for this manual • A

**Current command signal  $I_{command}$**  • 110

## D

**Data matrix code**

- example • 167
- on the nameplate • 166
- structure of the data matrix code • 167

**Date of manufacture on the nameplate** • 166**DDV** (Direct Drive Valve) • 17**diesel effect** • 142**dimensions**

- valves with CAN bus interface • 63

**Directives**, overview of quoted directives • 196**disposal** • 9**Documents, supplementing**

- catalog • 5
- ordering information • 174
- technical notes (TNs) • 5

**Drift of the internal pressure transducer**, monitoring the drift • 34, 136, 158**dust protection caps**

- for field bus connectors X3 and X4 • 135, 147
- for service connector X10 • 135, 147

**Duty cycle** • 171**Dynamic data** • 170

## E

**Electrical data** • 171**Electrical shielding** • 97–105

- electrical shielding** • 5, 101
  - connecting the shield • 102
  - connection with cable leadthrough • 102
  - connection with plug connection • 103
  - insulated shielding • 104
  - requirement of cable routing • 105
  - requirement of lines • 101

**Embrittlement of gaskets** • 156**embrittlement of gaskets** • 60**EMC**

- requirements during start-up • 127

**EMC** (Electromagnetic compatibility)

- EMC Directive • 196
- EMC protection requirements for immunity to interference and emitted interference • 171–172
- EMC standards • 171–172

**emissions** • 8**Emitted interference** • 171–172**Environmental protection**

- disposal • 9
- emissions • 8

**equipotential bonding**

- deficient equipotential bonding • 101
- electrical shielding • 101
- ground loops • 100
- insulated shielding in the event of deficient equipotential bonding • 104
- maximum potential difference (7 V) • 99
- of machines • 98
- performance • 99
- protective conductor • 100
  - cross section • 99

**ESD** (Electrostatic Discharge)

- Safety instructions • 16

**EtherCAT**

- general information • 87
- literature, additional, EtherCAT fundamentals • 193
- maximum number of bus nodes • 88
- module address • 123
  - auto-increment addressing • 123
  - fixed node addressing • 123
- pin assignment of the cables for EtherCAT networks • 122
- pin assignment, connector X3 • 89
- suitable cables for EtherCAT networks • 122
- Technical data • 88
- transmission rate • 123
- wiring diagram, EtherCAT networks • 122
- wiring EtherCAT networks • 121–123
  - Procedure • 121

**EU** (European Union)**Evenness**, required for mounting surface • 64**Exclusion of liability** • 11**Exclusion of warranty** • 11**External LVDT connector X8**

- in the block diagram of the valve/pump electronics • 73

## F

 $f_l$ 

- limit frequency • 108

**A B C D E F G H I J K L M N O P Q R S T U V W X Y Z**



**A B C D E F G H I J K L M N O P Q R S T U V W X Y Z**

**F<sub>1</sub>...F<sub>4</sub>** (position of the holes for mounting screws and attachment screws for the shipping plate in the hole pattern of the mounting surface) • 64

**factory setting of the valves** • 140

**Fail-safe events** • 27

control commands • 29

failure of the supply voltage • 27

restarting the valve

after occurrence of a fail-safe event • 30

settable fault reaction • 28

signals at the enable input • 28

**Fail-safe functions** • 24

electrical fail-safe function • 26

mechanical fail-safe functions • 25

valves with mechanical fail-safe function M • 25

Valves with mechanical fail-safe function F or D • 25

**Fail-safe identification**, in the type designation • 25

**Fail-safe states**

electrical fail-safe state • 24, 26–28

mechanical fail-safe state • 24–25, 27–28

**Field bus**

connection of the valve/pump

Safety instructions • 69

**field bus connectors X3 and X4**

in the connector overview • 74

**Field bus connectors X3 and X4**

cAN bus connectors • 85

EtherCAT connectors • 89

general information • 84

in the block diagram of the valve/pump electronics • 73

Profibus-DP connectors • 87

versions of the connectors • 84

**Field bus interface**

configuration of the valves via the field bus interface • 137

**Fill filter for hydraulic system**

required filter fineness  $\beta_x$  • 141

**Filling the hydraulic system** • 141

**Filter**, fill filter for hydraulic system

required filter fineness  $\beta_x$  • 141

**Filter fineness**  $\beta_x$

Fill filter for hydraulic system • 141

**FKM** (fluorocarbon rubber) • 169, 175

**Flow Q**

flow signal characteristic curve • 37, 52

formula for calculation • 51

leakage flow  $Q_L$  • 169

maximum flow  $Q_{max}$  • 51, 169

rated flow  $Q_N$  • 169

**Flow and pressure control (pQ-control)** • 17

**flow and pressure control (pQ-control)** • 34

block diagram • 34

**Flow control (Q-control)** • 17

trouble shooting in event of instability of the internal valve

control loop • 161

**flow control (Q-control)** • 32

block diagram • 32

**flow diagram** • 51

**Flow rate of a pump Q** • 142

**flow signal characteristic curve**

Characteristic curve • 52

design for measurement • 52

electrical zero position • 37

hydraulic zero position • 37

**Flow speed** • 51

**Flushing plate**

ordering information • 173

using when flushing the hydraulic system • 141

**flushing the hydraulic system** • 141

**Formulae**

Flow Q • 51

Minimum flushing time t of a hydraulic system • 142

**frequency response of the spool stroke** • 54

**function**

linear force motor • 19

Valve • 17

**Fuse protection**, external fuse protection for each valve • 171

## G

**GND**

ground contact of connector X1 • 76

**Ground connection of connector X1** • 76

**Ground contact (GND) of connector X1** • 76

**Ground (electrical)**

Ground contact (GND) of connector X1 • 76

single-ended command signals • 110

single-ended connection of the analog command inputs • 111

**Gumming of hydraulic fluid** during long-term storage • 60

## H

**handling in accordance with safety requirements** • 14, 68

**Handling, in accordance with safety requirements** • 14, 68

**HNBR** (hydrogenated nitrile butadiene acrylic rubber) • 169

**Hydraulic data** • 169

**Hydraulic fluid**

cleanliness level • 169

disposal • 9

permissible fluids • 169

permissible temperature range • 169

permissible viscosity  $\nu$  • 169

**hydraulic fluid**

cleanliness level • 142

diesel effect • 142

gumming during long-term storage • 60

required filter fineness  $\beta_x$  for fill filter for hydraulic system • 141

**Hydraulic symbols** • 35–36

on the nameplate • 166

**hydraulic symbols**

2x2-way operation • 36

2-way operation • 36

3-way operation • 35

4-way operation • 35

**Hydraulic system**

connection of the valve to the hydraulic system • 61, 66

filling and flushing • 141

minimum flushing time • 142

required filter fineness  $\beta_x$  for fill filter • 141

preparing • 141

Start-up • 142

start-up • 141–142

venting • 142

**Hysteresis** • 170

**A B C D E F G H I J K L M N O P Q R S T U V W X Y Z**



**A B C D E F G H I J K L M N O P Q R S T U V W X Y Z**

**I**

**I<sub>Command</sub>**  
current command signal • 110

**I<sub>out</sub>**  
output current • 111

**I<sub>Supply</sub>**  
supply current • 110

**ID** (Identifier)

**ID** (Inner Diameter, e.g. of O-rings)

**IEC** (International Electrotechnical Commission)

**Immunity to interference** • 171–172

**incremental transducer**  
power supply • 82  
reversal point of signals • 112  
speed variation of signals • 112

**Index of figures** • vii

**Index of Tables** • vii

**Initial start-up, safety instructions** • 68

**Input resistances at connectors X5...X7** • 92

**Input resistances R<sub>in</sub>**  
analog command inputs • 171

**Input voltage U<sub>in</sub>** • 111

**Inputs, analog command inputs**  
±10 mA differential • 43  
±10 V differential • 42  
0–10 mA differential • 46  
0–10 V differential • 45  
4–20 mA differential • 44, 47  
current inputs  
±10 mA differential • 43  
0–10 mA differential • 46  
4–20 mA differential • 44, 47  
flow control command inputs  
±10 mA differential • 43  
±10 V differential • 42  
4–20 mA differential • 44  
input resistances R<sub>in</sub> • 171  
pressure control command inputs  
0–10 mA differential • 46  
0–10 V differential • 45  
4–20 mA differential • 47  
signal type on the nameplate • 166  
signal types  
overview • 40  
signal type identification in the type designation • 41  
voltage inputs  
±10 V differential • 42  
0–10 V differential • 45

**Inputs, analog inputs**

at connectors X5...X7  
±10 V • 91  
0–10 mA • 91  
0–10 V • 91  
4–20 mA • 92  
benefits of the different signal types • 96  
Connections • 81  
in the block diagram of the valve/pump electronics • 73  
maximum current for transducer supply • 124  
on connector X1 • 76  
±10 mA • 79  
±10 V • 78  
0–10 mA • 79  
0–10 V • 78  
4–20 mA • 80  
overview of connections • 77  
pin assignment X5...X7 • 90  
power supply to the transducer • 90  
signal types  
at connectors X5...X7 • 91  
evaluating the signal types • 96  
on connector X1 • 78  
single-ended connection • 111  
Wiring • 124–126  
2-wire transducer • 125  
3-wire transducer • 125  
4-wire transducer • 125  
Connectors X5...X7 • 124–126

**Inputs, digital inputs**

Enable input • 171  
enable input • 28, 48, 76  
in the block diagram of the valve/pump electronics • 73  
signals at the enable input as fail-safe events • 28  
on connector X1  
enable input • 81  
overview of connections • 81

**Instability of the control loops, trouble shooting**

instability of the external control loop • 161  
instability of the internal valve control loops • 161

**Installation position** • 168

**Installation screws**

ordering information • 173

**Installation screws**

position of bores F<sub>1</sub>...F<sub>4</sub> in the mounting surface mounting pattern • 64  
required quality class • 65  
specification • 65  
tightening torque • 65  
width across flats • 65, 155

**intended operation** • 5

**Item numbers**

accessories • 173  
spare parts • 175

**L**

**I<sub>max</sub>**

maximum length of the supply cable • 106

**Leak, trouble shooting**

connecting surface of the valve • 159  
Venting screw • 159

**leakage flow Q<sub>L</sub>** • 169

**A B C D E F G H I J K L M N O P Q R S T U V W X Y Z**

**A B C D E F G H I J K L M N O P Q R S T U V W X Y Z**

**LED**

Status LEDs  
in the block diagram of the valve/pump electronics • 73

**Light emitting diodes (LEDs)**

status LEDs  
in the representative depiction of the valve • 18

**linear force motor • 19**

Armature • 19  
Bearing • 19  
Centering springs • 19  
Coil • 19  
Cross section • 19  
cutaway drawing • 19  
Permanent magnets • 19  
representative depiction • 19  
screw plug • 19

**Linearity of pressure control • 169****Literature, additional**

CAN fundamentals • 192  
directives, quoted • 196  
EtherCAT fundamentals • 193  
Fundamentals of hydraulics • 192  
Moog publications • 193  
Profibus fundamentals • 192  
standards, quoted • 193–196  
supplementing documents • 5

**Load impedance  $R_L$** 

analog actual value outputs • 111, 171

**LSS**

LSS address  
on the nameplate • 166

**LSS (Layer Setting Services)**

Example of a LSS address • 167  
structure of the LSS address • 167

**LVDT (Linear Variable Differential Transducer)**

in the representative depiction of the valve • 18

**LVDT (position transducer)**

in the block diagram of the valve/pump electronics • 73

**M****Maintenance**

O-ring checking and replacement  
ports • 157

**maintenance • 151–154****Manufacturer's declaration • 12****Marks, registered • 13****microprocessor system**

for storing the valve software parameters • 140  
in the valve electronics • 19

**Minimum flushing time for flushing the hydraulic system • 142****Mode of operation**

linear force motor • 19  
Valve • 17

**Model number**

example • 167  
on the nameplate • 166  
structure of the model number • 167

**Moog Valve Configuration Software • 50, 137–139**

operation • 129  
ordering information • 174  
possible faults • 129  
Safety instructions • ??–72, ??–129, ??–129  
safety instructions • 72, 128

**Mounting**

installation position • 168  
mounting option • 168  
orientation of the venting screw • 168

**mounting • 61, 66**

orientation of the venting screw • 67  
Procedure • 67

tools and materials required • 65

**mounting option • 168****mounting pattern of mounting surface • 64, 169****Mounting surface • 64**

cleaning • 67  
mounting pattern • 64, 169  
permissible average roughness  $R_a$  • 64  
required evenness • 64

**N****Nameplate • 165–166****NBR (nitrile butadiene acrylic rubber) • 175****NG (nominal size) • 169****Nominal size (NG) • 169****O****occupational safety and health**

safe distances for cardiac pacemakers and similar devices  
due to magnetic fields • 15  
safety equipment • 15  
sound insulation measures • 15

**operating pressure  $p_p$** 

maximum operating pressure • 169–170  
Maximum operating pressure on the nameplate • 166

**Operation of the valves • 144–148**

ambient conditions, permissible • 168  
intended operation • 5  
necessary preparations • 147

**operational modes • 17, 31****O-rings**

checking and replacing the O-rings  
ports • 157  
cleaning • 67  
embrittlement • 60, 156  
ordering information • 175  
permissible materials • 169  
Protection against ozone and UV effects with shipping  
plate • 58–59, 66, 134, 156  
service sealing set, ordering information • 173  
specification • 175

**Output current  $I_{out}$  • 111****Output voltage  $U_{out}$  • 111**

**A B C D E F G H I J K L M N O P Q R S T U V W X Y Z**

**A B C D E F G H I J K L M N O P Q R S T U V W X Y Z**

**Outputs, analog actual value outputs**

- overview • 171
- 4–20 mA (pressure actual value output) • 48
- 4–20 mA (spool position actual value output) • 48
- conversion of  $I_{out}$  (4–20 mA) into 2–10 V • 111
- load impedance  $R_L$  • 171
- pressure actual value output 4–20 mA • 48
- spool position actual value output 4–20 mA • 48

**Outputs, analog outputs**

- Connections • 81
- in the block diagram of the valve/pump electronics • 73
- on connector X1 • 76
  - 2–10 V • 80
  - 4–20 mA • 80
- overview of connections • 77

**Outputs, digital outputs**

- on connector X1
  - Valve standby • 81
- overview of connections • 81

**Overlap** • 35, 37, 169

**P**

**Packaging**

- disposal • 9
- storing original packaging • 60

**PC** (Personal Computer)

**PE**

- protective conductor contact of connector X1 • 76

**Permanent magnets of the linear force motor**

- in the representative depiction • 19

**PID** (Proportional Integral Differential)

- PID controller • 33

**pilot pressure  $p_x$**

- on the nameplate • 166

**Pilot valve connector X11**

- in the block diagram of the valve/pump electronics • 73
- pin assignment • 93

**pin assignment**

- X1 (connector)
  - 6+PE-pin • 76
- X2 (digital signal interface)
  - SSI transducer • 83
- X3 and X4 (field bus interface)
  - cAN bus • 85
  - EtherCAT • 89
  - Profibus-DP • 87
- X5...X7 (analog input connectors) • 90
- X10 (service connector) • 93
- X11 (pilot valve connector) • 93

**Ports**

- diameter of ports • 64, 169
- in the representative depiction of the valve • 18
- Leakage port Y • 36
  - Y identification in the type designation • 37
- on the nameplate • 166
- position of the ports in the mounting surface mounting pattern • 64

**ports**

- O-ring checking and replacement • 157
- trouble shooting in event of leaks • 159

**Position transducer (LVDT)**

- in the block diagram of the valve/pump electronics • 73

**Potentially explosive environment** • 168

**Power consumption  $P_{min}$  and  $P_{max}$**  • 171

**Power supply**

- Connection via connector X1 • 76
- failure of the supply voltage • 27
  - restarting the valve afterwards • 30
- Power supply • 171
  - on the nameplate • 166
- Power supply cord, order information • 174
- Requirements of supply voltage • 77
- SELV/PELV power pack
  - Ordering information • 174
- SELV/PELV power supply • 171
- Supply voltage
  - failure of the supply voltage • 27

**power supply**

- connection via connector X1 • 76

**Power supply cord, order information** • 174

**Pressure characteristic curve**

- Characteristic curve • 52
- Design for measurement • 52

**Pressure control (p-control)** • 17, 33

- Block diagram • 33
- Linearity of pressure control • 169
- Trouble shooting in event of instability of the internal valve control loop • 161

**Pressure controller**

- factory setting • 140
- in the p-control block diagram • 33
- in the pQ-control block diagram • 34
- notes on control response • 38
- trouble shooting in event of instability of the internal valve control loop • 161

**Pressure difference  $\Delta p$**  • 51

**pressure limitation** • 16, 133

**Pressure range identification, in the type designation** • 170

**Pressure transducer, internal**

- in the representative depiction of the valve • 18
- monitoring the drift • 34, 136, 158

**Pressure p**

- operating pressure  $p_P$ 
  - Maximum operating pressure on the nameplate • 166
- pilot pressure  $p_x$ 
  - on the nameplate • 166

**Procedure for electrically connecting valves/pumps** • 96

**Profibus**

- literature, additional, Profibus fundamentals • 192

**Profibus-DP**

- maximum number of bus nodes • 86
- pin assignment • 87
- Technical data • 86

**Profibus-DP interface**

- general information • 85

**Profibus-DP networks**

- cable cross section • 119
- cable length • 119
- module address • 120
- suitable cables • 120
- transmission rate • 120
- Wiring • 118–120
  - Procedure • 118
  - wiring diagram • 119

**Prohibition to duplicate** - user manual • A

**Prohibition to reproduce** - user manual • A

**Protection type by enclosure (IP)** • 171

**A B C D E F G H I J K L M N O P Q R S T U V W X Y Z**

**A B C D E F G H I J K L M N O P Q R S T U V W X Y Z**

**protective conductor**

- deficient equipotential bonding • 101
- ground loops • 100
- maximum potential difference (7 V) • 99
- procedure for connecting • 100
- required cross section • 99

**Protective conductor contact PE of connector X1 • 76****Protective grounding • 5, 97–105, 172**

- of connector X1 • 76
- of machines • 98
- performance • 99

**Q****q<sub>typ</sub>**

- typical cross section • 105

**Qualification**, requirements of the user • 7**Quality class**, required for installation screws • 65**R****ρ<sub>Cu</sub>**

- resistivity of copper • 105

**R<sub>L</sub>**

- load impedance R<sub>L</sub> of the analog actual value outputs • 111

**R<sub>typ</sub>**

- typical resistance • 105

**Rated flow Q<sub>N</sub> • 169****Rated pressure difference Δp<sub>N</sub> • 51****reference temperature of the valve electronics • 168–169****Release date of the user manual • 1****Removing • 151–156****repair • 151–154, 162****Representative depictions**

- linear force motor • 19
- servo valve • 18

**Responsibilities • 10****Responsibility** of the manufacturer and the operator of the machine • 10**restarting the valve • 30****Roughness R<sub>a</sub>, average**, permissible for mounting surface • 64**S****Safe distances** for cardiac pacemakers and similar devices due to magnetic fields • 15

**A B C D E F G H I J K L M N O P Q R S T U V W X Y Z**

**A B C D E F G H I J K L M N O P Q R S T U V W X Y Z**

**Safety instructions**

- general safety instructions • 16
  - ambient conditions, permissible • 168
  - analog command inputs • 42–47
  - attachment elements for the shipping plate • 66, 156
  - cleaning the valve connecting surface, mounting surface and O-rings • 67
  - configuration of the valves • 136, 147
  - connection to the hydraulic system • 61, 66
  - corrective maintenance • 151–154, 162
  - delivery of repaired valves and replacement valves with factory settings • 162
  - diesel effect • 142
  - disposal • 9
  - electrical and hydraulic zero positions • 37
  - electrical properties • 69
  - equipotential bonding • 71
  - ESD (Electrostatic Discharge) • 16
  - failure of the supply voltage • 27
  - flushing the hydraulic system • 141
  - handling in accordance with safety requirements • 14, 68
  - hydraulic connection • 61, 66
  - Hydraulic fluid • 15, 152
  - hydraulic fluid • 61, 131
    - diesel effect • 142
  - initial start-up • 68
    - connection to field bus • 69
  - installation •
    - 14–15, 21, 42–47, 69–70, 72–73, 97, 113, 117–118, 120–121, 123, 128–129, 153, 173
  - intended operation • 5
  - isolation from the mains system • 69
  - leak at the linear force motor screw plug • 159
  - linear force motor screw plug • 159
  - maintenance •
    - 14–15, 21, 42–47, 69–70, 72–73, 97, 113, 117–118, 120–121, 123, 128–129, 151, 153–154, 173
  - Moog Valve Configuration Software • 72, 128–129
  - mounting • 61, 66
  - mounting pattern of mounting surface • 64
  - occupational safety and health
    - safe distances for cardiac pacemakers and similar devices due to magnetic fields • 15
    - safety equipment • 15
    - sound insulation measures • 15
  - open connectors • 135, 147
  - operation • 144–147
  - original accessories and original spare parts • 154
  - potentially explosive environment • 168
  - power pack • 69
  - pressure control (p-control) • 32
  - pressure limitation • 16, 133
  - protective conductor system • 71
  - Removing • 151–154, 156
  - repair •
    - 14–15, 21, 42–47, 69–70, 72–73, 97, 113, 117–118, 120–121, 123, 128–129, 151, 153–154, 162, 173
  - restarting the valve after the valve has adopted the fail-safe state • 30
  - safety-critical applications • 24
  - selection and qualification of personnel • 7
  - service • 151–154
  - shipping plate • 156
  - shutting down the valve • 149
  - sound insulation measures • 8
  - start-up • 130–135
  - Storage • 58
  - storage • 58
  - structural modifications • 7
  - Supply voltage
    - failure of the supply voltage • 27
  - symbols, used • 3
  - Technical Data • 16, 147
  - Technical data • 164
  - transportation • 58
  - Trouble shooting • 151–154, 159–160
  - trouble shootingSafety instructions removing •
    - 14–15, 21, 42–47, 69–70, 72–73, 97, 113, 117–118, 120–121, 123, 128–129, 153, 173
  - typographical conventions • 3
  - use, intended • 5
  - valve software • 49, 136, 147
  - valve status 'NOT READY' • 20, 27–28
  - venting • 143
  - Venting screw • 67
  - zero positions, electrical and hydraulic • 37
- Safety shoes • 15**
- Safety-critical applications • 24**
- Scope of delivery • 60**
- Screw plug on the linear force motor**  
in the representative depiction • 19
- Sealing ring for venting screw**  
ordering information • 175  
trouble shooting in event of a leak at the venting screw • 159
- selection and qualification of personnel • 7**  
qualified users • 7
- SELV/PELV power pack**  
ordering information • 174
- SELV/PELV power supply • 171**
- SensorSup**  
supply voltage to the SSI transducer • 83
- Serial number** on the nameplate • 166
- service • 151–163**
- Service connector X10**  
general information • 93  
in the block diagram of the valve/pump electronics • 73  
pin assignment • 93
- service connector X10**  
in the connector overview • 74
- Service interface**  
configuration of the valves via the service interface • 139
- Service sealing set**, ordering information • 173
- Shipping plate • 58**  
attachment screws  
ordering information • 175  
fastening nuts, ordering information • 175  
ordering information • 175
- shipping plate • 134**  
Attachment screws • 66, 156  
in the installation drawing of the valve • 63  
position of bores F<sub>1</sub>...F<sub>4</sub> in the mounting surface  
mounting pattern • 64  
tightening torque • 156  
width across flats • 65, 155  
mounting • 156  
removal • 67
- Shock resistance • 168**
- shutting down the valve • 149**

**A B C D E F G H I J K L M N O P Q R S T U V W X Y Z**

**A B C D E F G H I J K L M N O P Q R S T U V W X Y Z**

**Signal cables**

- cable length • 109
- calculation
  - limit frequency • 108
  - typical capacitance  $C_{typ}$  • 105
  - typical resistance  $R_{typ}$  • 105
- dimensioning • 105
- influence of capacitance per unit length • 108
- influence of resistance • 108
- limit frequency • 108
- permissible lengths • 105–109
- recommendations • 108

**Signal interface, digital signal interface X2**

- in the block diagram of the valve/pump electronics • 73
- SSI transducer • 83

**Signal type identification in the type designation • 41****Signal types for analog command inputs**

- on the nameplate • 166

**Signal zero of connector X1 • 76****Signal, differential signal**

- evaluation • 96

**Software**

- Moog Valve Configuration Software • 50, 137–139
  - ordering information • 174
- valve software • 49
  - configuration of the valves • 49, 136
    - via the field bus interface • 137
    - via the service interface • 139
  - factory setting • 140
  - microprocessor system • 19
    - for storing parameters • 140

**sound insulation measures • 8, 15****Spare parts, ordering information • 175****Spool**

- bushing-spool identification in the type designation • 26
- defined spring-determined position of the spool in the mechanical fail-safe state • 25
- frequency response of the spool stroke • 54
- in the representative depiction of the valve • 18
- Overlap • 37, 169
- overlap • 35
- step response of the spool stroke • 54
- step response time for 0 to 100 % spool stroke • 170
- Zero lap • 37
- zero lap • 35, 169
- zero position (electrical and hydraulic) • 37

**Spool position controller**

- in the p-control block diagram • 33
- in the pQ-control block diagram • 34
- in the Q-control block diagram • 32

**SSI transducer**

- cable break monitoring • 82
- connection to valve/pump • 112
- pin assignment • 83
- power supply • 83
- recommended cable types • 82
- signals between valve/pump • 112
- supported transducer types • 82
- Wiring • 112
- wiring diagram • 112

**Standards**

- overview of quoted standards • 193–196
- CiA DSP • 167, 191, 193
- DIN • 194
- DIN EN • 194
- DIN EN ISO • 195
- IEC • 193
- IEEE • 193
- ISO • 196
- ISO/DIS • 194
- ISO/IEC • 194
- overview of quoted standards • ??–193

**Start-up**

- Hydraulic system • 142
- hydraulic system • 141–142
- restarting the valve • 30
- valve • 130–140

**start-up**

- EMC requirements • 127

**Static data • 170****step response of the spool stroke • 54****Step response time for 0 to 100 % spool stroke • 170****Storage • 58, 60**

- ambient conditions, permissible • 168
- embrittlement of gaskets • 60
- gumming of hydraulic fluid • 60
- original packaging • 60
- storage location for user manual • 2

**storage • 58, 60**

- embrittlement of gaskets • 60
- gumming of hydraulic fluid • 60
- original packaging • 60

**Structural modifications • 7****styles/spelling, used • 3****Subject to change without notice - user manual • A, 1****Supply cables**

- calculation
  - maximum length • 106
  - typical capacitance  $C_{typ}$  • 105
  - typical resistance  $R_{typ}$  • 105
  - voltage drop per unit length • 107
- dimensioning • 105
- permissible lengths • 105–109

**Supply current  $I_{supply}$  • 110****supply voltage**

- in the block diagram of the valve/pump electronics • 73

**Supply zero of connector X1 • 76**

**A B C D E F G H I J K L M N O P Q R S T U V W X Y Z**

**A B C D E F G H I J K L M N O P Q R S T U V W X Y Z**

**Symbols**

list of symbols • 190  
 $\beta_x$  • 190  
 $\Delta p$  (pressure difference)  
 $\Delta p_N$  (rated pressure difference)  
 $i_{comm}$  (current command signal)  
 $i_{in}$  (input current)  
 $i_{out}$  (output current)  
 $i_{supply}$  (supply current)  
 $l$  (length)  
 $\nu$  (viscosity)  
 $P_{max}$  (power consumption at maximum flow)  
 $P_{min}$  (power consumption for motor in neutral position)  
 $p$  (pressure)  
 $p_N$  (rated pressure)  
 $p_P$  (operating pressure)  
 $Q$  (flow)  
 $Q$  (flow rate of a pump)  
 $Q_L$  (leakage flow)  
 $Q_{max}$  (maximum flow)  
 $Q_N$  (rated flow)  
 $R_a$  (average roughness)  
 $R_{in}$  (input resistance)  
 $r_L$  (load impedance)  
 $T$  (Temperature)  
 $t$  (time)  
 $U_{cable}$  (voltage drop on the cable)  
 $u_{comm}$  (input voltage command signal)  
 $u_{in}$  (input voltage)  
 $u_{out}$  (output voltage)  
 $V$  (volume)

**symbols, used • 3**

**T**

$t$  (symbol for time)

**Table of contents • i**

**Technical data**

characteristic curves • 51–56  
 diagrams • 51–56  
 dimensions • 62  
 electrical data • 171  
 general technical data • 168  
 hydraulic data • 169  
 Installation drawings • 62  
 mounting pattern of mounting surface • 64, 169  
 static and dynamic data • 170

**Temperature T**

permissible ambient temperature • 168  
 permissible temperature range for hydraulic fluid • 169  
 reference temperature of the valve electronics • 168–169

**Throttle valve • 17**

**Tightening torques**

attachment screws for the shipping plate • 156  
 installation screws • 65  
 Venting screw • 143

**TN (Technical Note) • 5**

**Tools**

required for wiring valves/pumps • 95

**Trademarks, registered • 13**

**Transportation**

ambient conditions, permissible • 168

**transportation • 58**

transportation damage • 59

**Trouble shooting • 151–154, 158–161**

overview of possible faults • 158  
 instabilities of the control loop  
   external control loop • 161  
   internal valve control loops • 161  
 leak at the valve connecting surface • 159  
 leak at the venting screw • 159  
 no hydraulic response by the valve • 160

**TÜV (Technischer Überwachungsverein)**

**Type designation • 170**

bushing-spool identification • 26  
 fail-safe identification • 25  
 on the nameplate • 166  
 Pressure range identification • 170  
 signal type identification • 41  
 Y identification • 37

**typographical conventions • 3**

**U**

**$U_{Cable}$**

voltage drop on the cable • 111

**$U_{Command}$**

command signal of input voltage • 111

**$U_{dr\_max}$**

maximum voltage drop on the cable • 106

**$U_{min}$**

minimum supply voltage • 106

**$U_{out}$**

output voltage • 111

**$U_{in}$**

input voltage • 111

**USB (Universal Serial Bus)**

USB start-up module • 139  
 ordering information • 174

**use, intended • 5**

**User manual**

ordering information • 174  
 prohibition to duplicate • A  
 prohibition to reproduce • A  
 release date • 1  
 storage location • 2  
 styles/spelling, used • 3  
 subject to change without notice • A, 1  
 symbols, used • 3  
 typographical conventions • 3  
 version number • 1

**User manual M3000® and MSC-R**

copyright • A  
 duplication prohibition • A  
 reproduction prohibition • A

**Users, qualified • 7**

**UV (ultraviolet)**, protection of the seals against ozone and UV effects • 58–59, 66, 134, 156

**V**

$V$  (symbol for volume)

**A B C D E F G H I J K L M N O P Q R S T U V W X Y Z**



**A B C D E F G H I J K L M N O P Q R S T U V W X Y Z****Valve configurations** • 35–36, 169

- 2-way operation • 36
- 3-way operation • 35
- 4-way operation • 35
- hydraulic symbols
  - 2-way operation • 36
  - 3-way operation • 35
  - 4-way operation • 35

**Valve construction type** • 169**Valve electronics**

- reference temperature • 168–169

**valve electronics** • 19

- in the representative depiction of the valve • 18
- microprocessor system • 19
  - for storing the valve software parameters • 140

**valve software** • 49

- configuration of the valves • 49, 136
  - via the field bus interface • 137
  - via the service interface • 139
- factory setting • 140
- microprocessor system • 19
  - for storing the valve software parameters • 140

**Valve status**

- overview of the valve status • 20
- 'ACTIVE' • 20, 30
- 'DISABLED' • 20, 27, 29–30, 150, 168–169
- 'FAULT DISABLED' • 20, 27–28, 30
- 'FAULT HOLD' • 20, 24, 26–28, 30
- 'HOLD' • 20, 24, 26–27, 29–30
- 'INIT' • 20, 27, 29–30, 150
- 'NOT READY' • 20, 27–28

**Valve/pump electronics, block diagram** • 73**VDE** (Verband der Elektrotechnik Elektronik

- Informationstechnik e. V.)

**VDI** (Verein Deutscher Ingenieure e. V.)**venting**

- Hydraulic system • 142
- valve • 143

**Venting screw**

- in the installation drawing of the valve • 63
- in the representative depiction of the valve • 18
- orientation of the venting screw when mounting the valve • 67, 168
- procedure for venting the valve • 143
- sealing ring, ordering information • 175
- tightening torque • 143
- trouble shooting in event of a leak • 159
- width across flats • 143

**Version number of the user manual** • 1**Vibration resistance** • 168**Viscosity  $\nu$  of the hydraulic fluid** • 169**Voltage drop  $U_{\text{Cable}}$  on the cable** • 111**Wiring**

- tools and materials required • 95

**X1**

- 6+PE-pin connector • 110
- 11+PE-pin connector • 110

**X2**

- CAN network • 113
- SSI transducer • 112

**X3 and X4**

- CAN network • 113
- EtherCAT network • 121
- Profibus-DP network • 118

**X5...X7** • 124

- 2-wire transducer • 125
- 3-wire transducer • 125
- 4-wire transducer • 125

**Work gloves** • 15**Wrench sizes (WW)**

- Venting screw • 143

**wrench sizes (WW)**

- attachment screws for the shipping plate • 65, 155
- installation screws • 65, 155

**Y**

- Y identification** in the type designation • 37

**Z****Zero lap** • 35, 37**zero lap** • 169**Zero position of the spool**

- electrical zero position • 37
- hydraulic zero position • 37

**Zero shift** • 170**W****Valve configurations**

- 2x2-way operation • 36
- hydraulic symbols
  - 2x2-way operation • 36

**A B C D E F G H I J K L M N O P Q R S T U V W X Y Z**



# 15 Appendix

## 15.1 Abbreviations, symbols and identification letters

Fig.	Explanation
$\beta_x$	Symbol for filter fineness
$\Delta p$	symbol for pressure difference
$\Delta p_N$	symbol for rated pressure difference
$\nu$	symbol for viscosity
<b>A</b>	Valve port (consumer port)
<b>A</b>	Wiring the 6+PE-pin valve connector X1
<b>A/D</b>	<b>Analog-Digital</b> converter
<b>ACV</b>	<b>Axis Control Valve</b> (valve with axis control function)
<b>B</b>	Valve port (consumer port)
<b>B</b>	Wiring the 6+PE-pin valve connector X1
<b>C</b>	Wiring the 6+PE-pin valve connector X1
<b>CAN</b>	<b>Controller Area Network</b>
<b>CANopen</b>	Standardized communication profile
<b>CiA</b>	<b>CAN in Automation e. V.</b> (International Manufacturers' and Users' Organization for CAN Users; <a href="http://www.can-cia.org">http://www.can-cia.org</a> )
<b>D</b>	<b>Differential</b> (e. g.: in PID controller)
<b>D</b>	Fail-safe function <b>D</b> of valve
<b>D</b>	Wiring the 6+PE-pin valve connector X1
<b>D/A</b>	<b>Digital-Analog</b> converter
<b>DDV</b>	<b>Direct Drive Valve</b>
<b>DIN</b>	<b>Deutsches Institut für Normung e. V.</b> (German Institute for Standardization) ( <a href="http://www.din.de">http://www.din.de</a> )
<b>DSP</b>	<b>Draft Standard Proposal</b>
<b>E</b>	Wiring the 6+PE-pin valve connector X1
<b>EMC</b>	<b>Electromagnetic Compatibility</b>
<b>EN</b>	<b>Europa-Norm</b> (European standard)
<b>ESD</b>	<b>Electrostatic Discharge</b>
<b>EU</b>	<b>European Union</b>
<b>F</b>	Fail-safe function <b>F</b> of valve
<b>F</b>	Wiring the 6+PE-pin valve connector X1
<b>F<sub>1...F<sub>4</sub></sub></b>	Bore for installation screws or attachment screws for the shipping plate in the mounting pattern of the valve mounting surface
<b>FKM</b>	fluorocarbon rubber (material for gaskets, such as O-rings)
<b>G</b>	Bore for positioning pin in the mounting pattern of the valve mounting surface
<b>GND</b>	<b>Ground</b>
<b>I</b>	<b>Integral</b> (e.g. in PID controller)
<b>I<sub>in</sub></b>	Symbol for input current
<b>I<sub>out</sub></b>	Symbol for output current
<b>I<sub>Command</sub></b>	Symbol for current command signal
<b>I<sub>Supply</sub></b>	Symbol for supply current
<b>ID</b>	<b>Identifier</b>
<b>ID</b>	<b>Inner Diameter</b> (e.g. on O-rings)
<b>IEC</b>	<b>International Electrotechnical Commission</b> ( <a href="http://www.iec.ch">http://www.iec.ch</a> )

**Tab. 32: Abbreviations, symbols, and identification letters**

Tab. 32: Abbreviations, symbols and identification letters (Part 1 of 3)

Fig.	Explanation
IP	International Protection (IP code; degree of protection type by enclosure as per EN 60529)
ISM	Industrial, scientific and medical (industrial, scientific, and medical, e. g. for ISM devices)
ISO	International Organization for Standardization ( <a href="http://www.iso.org">http://www.iso.org</a> )
LED	Light Emitting Diode
LSS	Layer Setting Services as per CiA DSP 305 (LSS offers the option of setting the node parameters, such as module address or transmission rate, of a CAN node via the CAN bus)
LVDT	Linear Variable Differential Transformer (position transducer; senses the position of the spool in the valve)
M	Fail-safe function M of valve
NBR	Nitrile Butadiene Rubber (material for gaskets, such as O-rings)
NG	Nominal size of the valve, e.g. 6
P	Proportional (e.g. in PID controller)
P	Valve port (pressure port)
P <sub>max</sub>	Symbol for power consumption at maximum flow
P <sub>min</sub>	Symbol for power consumption with motor in neutral position
P	Symbol for pressure (Pressure)
P <sub>N</sub>	Symbol for rated pressure
P <sub>P</sub>	Symbol for operating pressure
PC	Personal Computer
PE	Protective Earth
PE	Wiring the 6 or 11+PE-pin valve connector X1
PELV	Protective Extra Low Voltage
PID	Proportional Integral Differential (e. g. in PID controller)
PWM	Pulse Width Modulation
Q	Symbol for flow
Q	Symbol for flow rate of a pump
Q <sub>L</sub>	Symbol for leakage flow
Q <sub>max</sub>	Symbol for maximum flow
Q <sub>N</sub>	Symbol for rated flow
R <sub>a</sub>	Symbol for average roughness
R <sub>In</sub>	Symbol for input resistance
R <sub>L</sub>	Symbol for load impedance
SELV	Safety Extra Low Voltage (low voltage)
WAF	Width Across Flats for wrenches
T	Symbol for temperature
T	Valve port (tank port)
T	Symbol for time
TN	Technical Note
TÜV	Technischer Überwachungsverein (German Technical Inspection Agency)
U <sub>in</sub>	Symbol for input voltage
U <sub>out</sub>	Symbol for output voltage
U <sub>comm</sub>	Symbol for input voltage command signal
U <sub>cable</sub>	Symbol for voltage drop on the cable
USB	Universal Serial Bus
UV	Ultraviolet
V	Symbol for volume (such as tank capacity)

**Tab. 32: Abbreviations, symbols, and identification letters**

Tab. 32: Abbreviations, symbols and identification letters (Part 2 of 3)

Fig.	Explanation
VDE	Verband der Elektrotechnik Elektronik Informationstechnik e. V. (German Association of Electrical Engineering, Electronics and Information Technology) ( <a href="http://www.vde.de">http://www.vde.de</a> )
VDI	Verein Deutscher Ingenieure e. V. (Association of German Engineers) ( <a href="http://www.vdi.de">http://www.vdi.de</a> )
X	Valve port
X1...X10	Designations for the valve connectors
Y	Valve port (leakage port)

Tab. 32: Abbreviations, symbols and identification letters (Part 3 of 3)

**Tab. 32: Abbreviations, symbols, and identification letters**

## 15.2 Additional literature

### 15.2.1 Fundamentals of hydraulics

**Findeisen, Dietmar und Findeisen, Franz:**  
Ölhydraulik; Springer-Verlag

**Additional literature:  
fundamentals of  
hydraulics**

**Murrenhoff, Univ.-Prof. Dr.-Ing. Hubertus:**  
Grundlagen der Fluidtechnik - Teil 1: Hydraulik (Vorlesungsumdruck des IFAS der RWTH Aachen)  
<http://www.rwth-aachen.de/ifas>

**Murrenhoff, Univ.-Prof. Dr.-Ing. Hubertus:**  
Servohydraulik (Vorlesungsumdruck des IFAS der RWTH Aachen)  
<http://www.rwth-aachen.de/ifas>

**Murrenhoff, Univ.-Prof. Dr.-Ing. Hubertus:**  
Steuerungs- und Schaltungstechnik II (Vorlesungsumdruck des IFAS der RWTH Aachen)  
<http://www.rwth-aachen.de/ifas>

**Schäfer, Dr. Klaus D.:**  
Stetighydraulik - Grundlagen, Ventiltechnik, Regelkreise; Die Bibliothek der Technik, Band 215; Verlag Moderne Industrie

### 15.2.2 CAN fundamentals

**CAN in Automation e. V.:**  
<http://www.can-cia.org>

**Additional literature: CAN  
fundamentals**

**Etschberger, Konrad (editor):**  
CAN - Controller-Area-Network - Grundlagen, Protokolle, Bausteine, Anwendungen; Carl Hanser Verlag

**Lawrenz, Wolfhard (editor):**  
CAN - Controller Area Network - Grundlagen und Praxis; Hüthig Verlag

### 15.2.3 Profibus fundamentals

**PROFIBUS Users' Organization:**  
<http://www.profibus.com>

**Additional literature:  
Profibus fundamentals**

**Popp, Manfred:**  
PROFIBUS-DP/DPV1 - Grundlagen, Tipps und Tricks für Anwender; Hüthig Verlag

## 15.2.4 EtherCAT fundamentals

**EtherCAT Technology Group:**  
<http://www.ethercat.org>

**Additional literature:**  
**EtherCAT fundamentals**

## 15.2.5 Moog publications

**Press releases:**  
<http://www.moog.com/industrial/news>

**Additional literature:**  
**Publications by our  
company**

**Newsletters:**  
<http://www.moog.com/industrial/newsletter>

**Articles in technical journals:**  
<http://www.moog.com/industrial/articles>

**Presentations and scientific publications:**  
<http://www.moog.com/industrial/papers>

**User manuals, TNs, catalogs, and similar:**  
<http://www.moog.com/industrial/literature>

## 15.3 Quoted standards

### 15.3.1 CiA DSP

**CiA DSP 305**  
CiA Draft Standard Proposal: CANopen Layer Setting Services and Protocol (LSS)

**Quoted standards:**  
**CiA DSP**

### 15.3.2 TIA/EIA

**ANSI/TIA/EIA-568-B.1**  
Commercial Building Telecommunications Cabling Standard Part 1: General Requirements

**Quoted standards: EIA**

**EIA 422**  
Electrical Characteristics of Balanced Voltage Digital Interface Circuits

**TIA/EIA-485-A**  
Electrical Characteristics of Generators and Receivers for Use in Balanced Digital Multipoint Systems

### 15.3.3 IEC

**IEC 62407**  
Real-time Ethernet control automation technology (EtherCAT™)

**Quoted standards: IEC**

### 15.3.4 IEEE

**IEEE 802.3**  
Carrier Sense Multiple Access with Collision Detection (CSMA/CD) Access Method and Physical Layer

**Quoted standards**

## 15.3.5 ISO, ISO/IEC

### ISO 11898

Road vehicles – CAN protocol

Quoted standards: ISO,  
ISO/IEC

### ISO/IEC 8802-3

Information technology - Telecommunications and information exchange between systems - Local and metropolitan area networks, specific requirements - Part 3: Carrier sense multiple access with collision detection (CSMA/CD) access method and physical layer specifications

## 15.3.6 DIN

### DIN 51524-1

Pressure fluids; Hydraulic oils Part 1: HL hydraulic oils; Minimum requirements

Quoted standards: DIN

### DIN 51524-2

Pressure fluids; Hydraulic oils Part 2: HLP hydraulic oils; Minimum requirements

### DIN 51524-3

Pressure fluids; Hydraulic oils Part 3: HVLP hydraulic oils; Minimum requirements

### DIN 61000

Electromagnetic compatibility (EMC)

## 15.3.7 EN

### EN 563

Safety of machinery – Temperatures of touchable surfaces – Ergonomics data to establish temperature limit values for hot surfaces

Quoted standards: EN

### EN 982

Safety of machinery – Safety requirements for fluid power systems and their components – Hydraulics

### EN 55011

Industrial, Scientific And Medical Equipment (ISM devices) –Radio-frequency Disturbance Characteristics –Limits And Methods Of Measurement

### EN 60068-2-6

Environmental tests – Part 2: Tests; test Fc: vibration, sinus-shaped (IEC 60068-2-6:1995 + Corrigendum 1995)

### EN 60068-2-27

Environmental tests – Part 2: Tests; test Ea and guidelines: shocks (IEC 60068-2-27:1987)

### EN 60079-0

Explosive atmospheres. Equipment. General requirements - Part 0: Operating materials - general requirements

### EN 60079-1

Electrical apparatus for explosive gas atmospheres - Part 1: Flameproof enclosures 'd'

### EN 60079-7

Explosive atmospheres - Part 7: Equipment protection by increased safety "e"

- EN 60204**  
Safety of machinery – Electrical equipment of machines
- EN 60529**  
Protection types provided by enclosures (IP code)
- EN 61000-6-2**  
Electromagnetic compatibility (EMC) – Part 6-2: Generic standards – Immunity to interference for industrial environments
- EN 61000-6-3**  
Electromagnetic compatibility (EMC) – Part 6-3: Generic standards – Emitted interference for residential, commercial and light-industrial environments
- EN 61000-6-4**  
Electromagnetic compatibility (EMC) – Part 6-4: Generic standards – Emitted interference for industrial environments
- EN 61076-2-101**  
Connectors for electronic equipment - Part 2-101: circular connectors - type specification for circular connector M8 with screw or snap locking and M12 with screw locking for low-voltage applications
- EN 61558-1**  
Safety of power transformers, power supplies, reactors and similar products – Part 1: General requirements and tests
- EN 61158-2**  
Digital data communication in instrumentation and control – Field bus for industrial control systems
- EN 61558-2-6**  
Safety of transformers, reactors, power supply units and similar products for supply voltages up to 1100 V – Part 2-6: Special requirements and tests for safety transformers and power supplies that contain safety transformers
- EN 175201-804**  
Type specification –Circular connectors – Round contacts, size diameter 1.6 mm –threaded coupling

### 15.3.8 EN ISO

- EN ISO 1302**  
Geometrical Product Specifications (GPS) Indication of surface texture in technical product documentation
- EN ISO 4762**  
Hexagon socket head cap screws
- EN ISO 12100**  
Safety of machinery – Basic concepts, general principles for design
- EN ISO 13849-1**  
Safety of machinery – Safety-related parts of control systems – Part 1: General design principles
- EN ISO 13849**  
Safety of machinery – Safety requirements for fluid power systems and their components – Hydraulics

**Quoted standards:**  
**EN ISO**

## 15.3.9 ISO

### ISO 4401

Hydraulic fluid power – 4-port directional control valves – Mounting surfaces

**Quoted standards: ISO**

### ISO 4406

Hydraulic fluid power – Fluids – Method for coding level of contamination by solid particles

### ISO11158

Lubricants, industrial oils and related products (class L) -- Family H (hydraulic systems) -- Specifications for categories HH, HL, HM, HV and HG

## 15.4 Quoted directives

### 2006/42/EC

Directive 2006/42/EG of the European Parliament and Council for alignment of the legal and administrative provisions of the Member States for machinery

**Quoted directives**

### 2004/108/EC

Directive 2004/108/EC concerning electromagnetic compatibility (EMC)

### 94/9/EG

ATEX product guideline

### 1999/92/EG

ATEX operating guideline



VDI offers numerous directives for downloading:

<http://www.vdi-nachrichten.com/ce-richtlinien/basics/richtlinien.asp> .

## 15.5 Explosion-proof connectors

Instructions from the company Cooper Crouse-Hinds GmbH

**eXLink 4-polig Stecker, Kupplung/  
4-pole plug, coupler/  
4 pôles fiche, prolongateur**



**COOPER** Crouse-Hinds

**Technische Angaben**

Gerätekennzeichnung nach 94/9/EG und Norm:	
	⊕ II 2 G Ex de IIC T6 ⊕ II 2 G Ex ia/ib IICT6 ⊕ II 2 D Ex tD A21 IP 66 T80°C
nach CSA	Class I, Zone 1 Ex de IIC T6 Class I, Div 2; Gr. A,B,C,D
EG-Baumusterprüfbescheinigung: PTB 03 ATEX 1016 X	
Zulässige Umgebungs- temperatur:	-25°C/-55°C bis +40°C <sup>1)</sup>
Bemessungsspannung:	bis 250 V, 50/60 Hz
Bemessungsstrom:	max. 10 A
Leitungseinführung ø:	Standard Optional
Stecker, Kupplung	ø 4-7,5 mm ø 7,5-11 mm
Anschlussquerschnitt:	1x0,75-1,5 mm <sup>2</sup> /2,5 mm <sup>2</sup>
Anschlussleitung	Draka ToughCat 7 LSHF-FR 4x2/0,27 MUD
Vibrationsfestigkeit nach EN 60068-2-6 10-150 Hz: 2g / 30 min <sup>2)</sup>	
Prüfdrehmomente:	
Arretierungsschraube	1,0 Nm
Überwurfmutter	2,5 Nm
Druckschraube -ø 4-7,5 mm	3,5 Nm
Druckschraube -ø 7,5-11 mm	3,5 Nm

- 1) die besonderen Bedingungen gemäß Prüfschein PTB 03 ATEX 1016 X sind zu beachten.  
2) Die Hinweise im Kapitel „Montage“ beachten!

**Technical Data**

Apparatus marking acc. to 94/9/EC & directive	
	⊕ II 2 G Ex de IIC T6 ⊕ II 2 G Ex ia/ib IICT6 ⊕ II 2 D Ex tD A21 IP 66 T80°C
acc. CSA	Class I, Zone 1 Ex de IIC T6 Class I, Div 2; Gr. A,B,C,D
EC type examination certificate: PTB 03 ATEX 1016 X	
Permissible ambient temperature:	-25°C/-55°C to +40°C <sup>1)</sup>
Rated voltage:	up to 250 V, 50/60 Hz
Rated current:	max. 10 A
Cable entry ø:	Standard Optional
Plug, coupler	ø 4-7.5 mm ø 7.5-11 mm
Terminal cross section:	1x0.75-1.5 mm <sup>2</sup> /2.5 mm <sup>2</sup>
Cable:	Draka ToughCat 7 LSHF-FR 4x2/0.27 MUD
Vibration resistance acc. EN 60068-2-6 10-150 Hz: 2g / 30 min <sup>2)</sup>	
Test torques:	
Locking screw	1.0 Nm
Coupling nut	2.5 Nm
Pressure screw -ø 4-7,5 mm	3.5 Nm
Pressure screw -ø 7,5-11 mm	3.5 Nm

- 1) observe special requirements accd. certification PTB 03 ATEX 1016 X.  
2) Follow the instructions in the chapter 'Installation'!

**Caractéristiques techniques**

Marquage de l'appareil selon 94/9/CE & directive	
	⊕ II 2 G Ex de IIC T6 ⊕ II 2 G Ex ia/ib IICT6 ⊕ II 2 D Ex tD A21 IP 66 T80°C
en fonction de CSA	Class I, Zone 1 Ex de IIC T6 Class I, Div 2; Gr. A,B,C,D
Attestation d'examen CE de type: PTB 03 ATEX 1016 X	
Température ambiante admissible:	-25°C/-55°C à +40°C <sup>1)</sup>
Tension nominale:	jusqu'à 250 V, 50/60 Hz
Courant nominal:	max. 10 A
Entrée de câble ø:	Standard Optional
Fiche, Prolongateur	ø 4-7,5 mm ø 7,5-11 mm
Section raccordement:	1x0,75-1,5 mm <sup>2</sup> /2,5 mm <sup>2</sup>
Cable:	Draka ToughCat 7 LSHF-FR 4x2/0,27 MUD
Résistance aux vibrations selon EN 60068-2-6 10-150 Hz: 2g / 30 min <sup>2)</sup>	
Couples de serrage testés:	
Vis d'arrêt	1,0 Nm
Collerette de fixation	2,5 Nm
Vis de serrage ø 4-7,5 mm	3,5 Nm
Vis de serrage ø 7,5-11 mm	3,5 Nm

- 1) Respecter les précautions particulières selon l'attestation d'examen CE de type PTB 03 ATEX 1016 X  
2) Suivre les instructions du chapitre 'Montage'!

**Sicherheitshinweise**



**Vor dem Öffnen der Druckschraube am Stecker und Kupplung, ist die Spannungsfreiheit sicherzustellen. Die Montageanleitung darf nur zusammen mit der ausführlichen Betriebsanleitung „GHG5707001P0001“ (unter [www.ceag.de](http://www.ceag.de) erhältlich) verwendet werden. Die Benutzerinformationen für „MOOG-Ventile“ sind zu beachten ([www.Moog.com/industrial](http://www.Moog.com/industrial)). Das Konfektionieren der Steckverbinder darf nur durch Fachkräfte erfolgen. Die Steckverbindungen eXLink sind nicht für den Einsatz in der Zone 0 oder 20 geeignet. Zur Sicherstellung des Explosionsschutzes dürfen in die Bohrungen von druckfesten Gehäusen nur Gerätestecker und Flansch-steckdosen aus Metall eingesetzt werden. Gerätestecker und Flanschsteckdosen aus Metall sind durch geeignete Maßnahmen in das Erdpotential der Gehäuse bzw. Geräte mit einzubeziehen. Die unter Spannung stehenden Steckverbindungskomponenten müssen sofort nach dem Trennen mit der Schutzkappe verschlossen werden, damit die Schutzart und damit der Explosionsschutz sichergestellt wird.**

**Safety instructions**



**Before opening the pressure screw on the plug and coupler, ensure that it has been isolated from the supply. The assembly instructions must be used in conjunction with the detailed operating instructions „GHG5707001P0001“ (available from [www.ceag.de](http://www.ceag.de)). The user information for „MOOG-Ventile“ must be observed ([www.Moog.com/industrial](http://www.Moog.com/industrial)). The configuration of plug and socket systems shall only be carried out by qualified personnel. Plug and socket systems of the type eXLink are not suited for use in Zone 0 or 20 areas. In order to guarantee the explosion protection, only inlets and flange sockets made of metal may be fitted in the boreholes of flameproof enclosures. The metal flang sockets and inlets shall be incorporated in the earth potential equalization. When opened, the live plug and socket system components shall be sealed immediately after disconnection using the protective cap. Here it is necessary to ensure that it is closed correctly, otherwise the minimum degree of protection and the explosion protection are no longer guaranteed.**

**Instructions de sécurité**



**Avant de relâcher la vis de pression sur la prise et le prolongateur, vérifiez l'absence de tension. Utilisez la notice de montage uniquement en association avec les instructions détaillées de service „GHG5707001P0001“ (disponibles sur le site [www.ceag.de](http://www.ceag.de) ). Les informations utilisateur pour les „MOOG-Ventile“ doivent être respectées ([www.Moog.com/industrial](http://www.Moog.com/industrial)). Seul un personnel qualifié est autorisé à effectuer le branchement électrique des connecteurs mâles-femelles. Les connecteurs mâles-femelles eXLink ne conviennent pas pour une utilisation en zone 0 et 20. Afin de garantir une protection antidéflagrante, seuls des socles connecteurs et des prises de courant à bride métalliques doivent être montés dans les évidements des boîtiers à l'épreuve de la pression. Les prises à bride aux métal et les sockles connecteur aux métal doivent être reliés au même potentiel. Après déconnexion, les éléments de connexion encore sous tension doivent immédiatement être protégés à l'aide d'obturateurs.**



# Montageanleitung / Mounting instructions / Mode d'emploi

	ohne PE-Bügel without PE-shackle sans étrier de PE		mit PE-Bügel with PE-shackle avec étrier de PE
Anschlussquerschnitt	0,75 - 1,5mm <sup>2</sup> oder 2,5mm <sup>2</sup>		
Cross section	0,75 - 1,5mm <sup>2</sup> or 2,5mm <sup>2</sup>		
Section de raccordement	0,75 - 1,5mm <sup>2</sup> ou 2,5mm <sup>2</sup>		

## Kupplung Coupler Prolongateur

(PE-Bügel, nur 4+1)  
(PE-clamp, only with 4+1)  
(étrier de PE, seulement 4+1)

(PE)

6 h

28 95

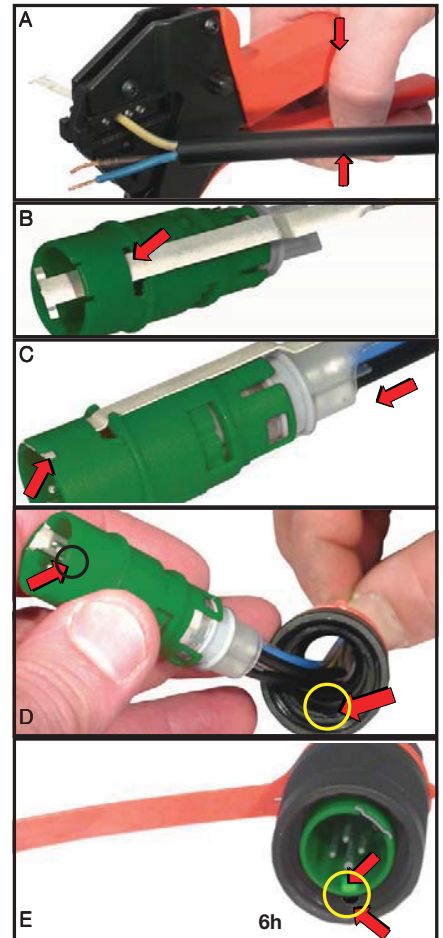

## Stecker Plug Fiche

(PE-Bügel, nur 4+1)  
(PE-clamp, only with 4+1)  
(étrier de PE, seulement 4+1)

(PE)

Ausführung 4-polig (3+PE)  
= ohne PE-Bügel

Version 4-pole (3+PE)  
= without PE-clamp

Version 4 pôles (3+PE)  
= sans l'étrier de PE

1 h 5 h

6 h 10 h

28 96

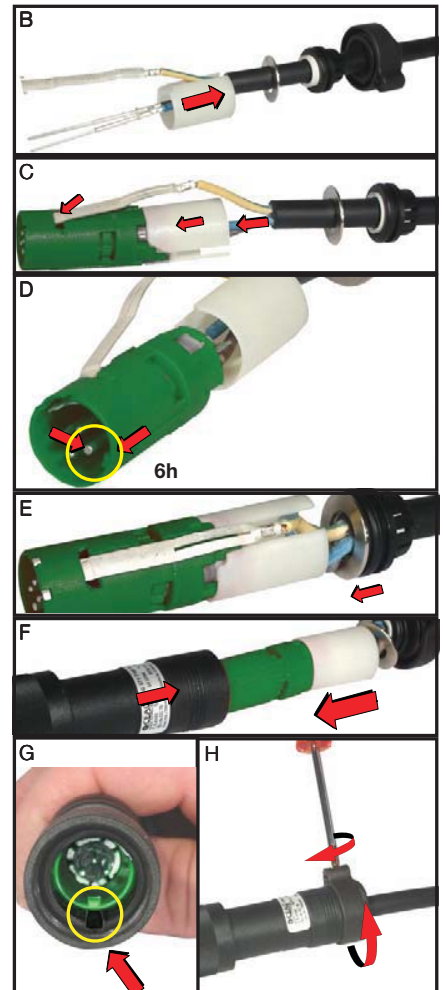

## Stecker/Kupplung öffnen

1. Eventuell vorhandene Schutzkappe abschrauben.
2. Arretierschraube lösen.
3. Druckstück aus Hülse herausdrehen.
4. Einsatz von vorne aus der Hülse herausdrücken.
5. Dabei Zugentlastung, Dichtung, Druckscheibe, Isolierhülse aus Hülse nach hinten heraus nehmen.
6. Farbring zur Kennzeichnung auf Hülse aufziehen.

## Leiter mit Stiften / Buchsen verbinden

**⚠ Die Isolation des Leiters muss bis an die Stifte / Buchsen heranreichen. Der Leiter darf nicht beschädigt sein.**

1. Kabel ca. 30 mm abmanteln.(Fig.1)
2. Leiter des Kabels ca. 8 mm abisolieren.

## Stifte / Buchsen anschließen

1. Leiter in die Anschlussöffnung der Stifte / Buchsen stecken.
2. Alle Leiter mit der Crimpzange (→ Zubehör) ancrimpen (Fig.A) oder  
Alle Leiter mit Stiften/Buchsen verlöten und  
Schrumpfschlauch über jede Lötstelle ziehen.

## Stecker/Kupplung montieren

**⚠ Auch Stifte/Buchsen montieren, die nicht angeschlossen sind.**

**⚠ Die Stifte/Buchsen sind nach dem Eindringen in den Einsatz nicht mehr demontierbar.**

1. Druckstück, Zugentlastung, Dichtung und Druckscheibe auf Kabel aufschieben.
2. Der Stift/die Buchse der Position 4 hat einen größeren Durchmesser. Diesen zuerst in seine Halterung stecken. Alle Stifte / Buchsen bis zum hörbaren Einrasten in die Sechskantführung des Einsatzes drücken.
3. Isolierhülse auf Einsatz schieben.
4. Einsatz mit Führungsnase in die Führungsnut der Hülse stecken (Fig.G).
5. Druckscheibe, Dichtung, Zugentlastung montieren.
6. Druckstück (2) festschrauben (Drehmoment -> Technische Daten).
7. Arretierschraube festschrauben (Fig. H).

## Plug open

1. Screw down possible existing protective cap. .
2. Loosen locking screw.
3. Screw out pressure piece of plug sleeve.
4. Press out from front plug insert out of plug sleeve.
5. At the same time, remove the strain relief, seal, thrust washer and insulating sleeve from the plug sleeve from the back.
6. Fit coloured ring used for marking on to the plug sleeve.

## Connecting conductors to pins

**⚠ The insulation of the conductor shall reach up to the pins. The conductor must not be damaged.**

1. Strip off ca. 30 mm of cable insulation.(Fig.1)
2. Strip off ca. 8 mm of insulation from cable conductors.

## Crimp plugs/contacts

1. Insert conductor into the connection opening of the plug/contact pin.
2. Crimp on all conductors using crimping tool (→ Accessories) [Fig.A] or  
solder all conductors to plug pins/contact and pull shrink-on sleeve over each solder ring point.

## Assembling plugs/coupler

**⚠ Also assemble plug/coupler pins that are not connected.**

**⚠** Once they have been pressed into the plug/coupler insert, the plug pins cannot be disassembled.

1. Push pressure piece, strain relief, seal and thrust washer on to cable.
2. The plug/contact pin, Item 4, is larger in diameter. To avoid mistakes, put this into the holder first. Push all the plug pins into the hexagonal keyways of the plug/coupler insert until they engage.
3. Push the insulating sleeve on to the plug insert.
4. Insert the plug insert with guide lug into the keyway of the plug sleeve (Fig.G).
5. Fit thrust washer, seal and strain relief.
6. Screw pressure piece tight [torque -> Technical Data]
7. Tighten locking screw (Fig. H).

## Ouverture de la fiche

1. Dévisser le capuchon (si monté) de la fiche.
2. Dévisser la vis d'arrêt.
3. Sortir en la tournant la pièce de pression de la douille de fiche.
4. Extraire par l'avant le bloc de fiche de la douille de fiche.
5. Retirer pendant cette opération par l'arrière la décharge de tension, le joint, la rondelle de pression, la douille isolante de la douille de fiche.
6. Monter la bague en couleur comme repère sur la douille de fiche.

## Raccordement des conducteurs aux contacts mâles/femelles

**⚠ L'isolation du conducteur doit arriver jusqu'aux contacts . Le conducteur ne doit pas être endommagé.**

1. Dénuder le câble sur env. 30 mm.(Fig.1)
2. Dénuder les conducteurs du câble sur env. 8 mm.

## Présertir Fiche/Prolongateur

1. Enficher le conducteur dans l'ouverture du contact mâle/femelle.
2. Pré-sertir tous les conducteurs avec la pince à sertir (→ accessoire) (Fig.A) ou  
braser tous les conducteurs avec les contacts mâles/femelles et enfiler la gaine thermorétractable sur chaque brasure.

## Montage de la fiche/du prolongateur

**⚠ Monter aussi les contacts mâles/femelles non raccordés.**

**⚠** Les contacts mâles/femelles ne peuvent plus être démontés après avoir été pressés dans le bloc de fiche.

1. Monter la pièce de pression, la décharge de tension.
2. Le contact mâle/femelle de la position 4 a un plus gros diamètre. Pour éviter toute confusion, enficher celui-ci en premier dans son support. Enfoncer tous les contacts mâles/femelles jusqu'à l'enclenchement dans le guidage hexagonal du bloc de fiche.
3. Monter la douille isolante sur le bloc de fiche.
4. Engager le bloc de fiche avec l'ergot de guidage dans la rainure de guidage de la douille de fiche (Fig.G).
5. Monter la rondelle de pression, le joint, la décharge de tension.
6. Visser la pièce de pression (couple -> Caractéristiques techniques).
7. Visser la vis d'arrêt (Fig. H).

## Handhabung

- A/A1** Den Stecker mit der Führungsnase lagerichtig in die entsprechende Führungsnut der Kupplung bis zum 1. Anschlag einstecken (**B**).
- B1** Danach den Stecker um ca. 30° nach rechts bis zum Begrenzungsanschlag drehen.
- C** Stecker bis zum Endanschlag mit der Kupplung zusammenstecken.
- D** Überwurfmutter „handfest“ an der gesteckten Steckverbindung.

## Handling

- A/A1** Insert the plug into the coupler until they reach the 1<sup>st</sup> stop. Ensure that the position of the key on the plug corresponds to that of the keyway on the coupler (**B**).
- B1** Then turn the plug to the right through ca. 30° until it reaches the stop.
- C** Insert plug into coupler until it reaches the final stop.
- D** Tighten the coupling nut on the connected plug and socket.

## Manoeuvre

- A/A1** Introduisez la fiche en positionnant correctement l'ergot de guidage dans la rainure de guidage correspondante du prolongateur jusqu'à la 1<sup>ère</sup> butée (**B**).
- B1** Ensuite, tournez la fiche d'environ 30° vers la droite jusqu'en butée de limitation.
- C** Assemblez la fiche et le prolongateur jusqu'en butée.
- D** Vissez à fond la collerette de fixation sur le connecteur enfiché.

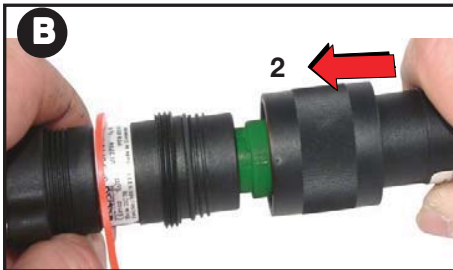
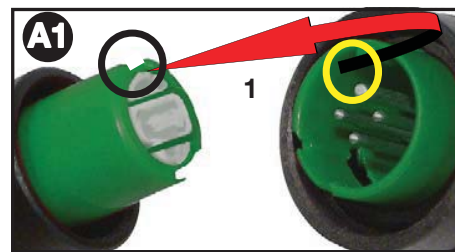
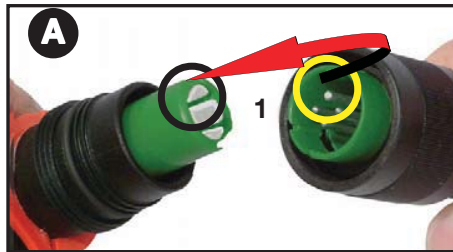

## Normenkonformität

Das Steckverbindungssystem entspricht den in der Konformitätserklärung aufgeführten Normen und den vergleichbaren IEC Standards

IEC 60079-0, IEC 60079-1, IEC 60079-7, IEC 61241-0, IEC 61241-1.

CAN/CSA C22.2 E60079-0-02

CAN/CSA C22.2 E60079-1-02

CAN/CSA C22.2 E60079-7-2003

CAN/CSA C22.2 No 213

CAN/CSA C22.2 No 182.3 M1987

CAN/CSA C22.2 No 94.1-07

94/9 EG: Geräte und Schutzsysteme zur bestimmungsgemäßen Verwendung in explosionsgefährdeten Bereichen.

Das Steckverbindungssystem ist gemäß DIN EN ISO 9001 entwickelt, gefertigt und geprüft worden.

## Conformity with standards

The plug and socket system is conform to the standards specified in the EC-Declaration of conformity and additional conform to the comparable IEC Standards

IEC 60079-0, IEC 60079-1, IEC 60079-7, IEC 61241-0, IEC 61241-1.

CAN/CSA C22.2 E60079-0-02

CAN/CSA C22.2 E60079-1-02

CAN/CSA C22.2 E60079-7-2003

CAN/CSA C22.2 No 213

CAN/CSA C22.2 No 182.3 M1987

CAN/CSA C22.2 No 94.1-07

94/9 EC: Equipment and protective systems intended for use in potentially explosive atmospheres.

It has been designed, manufactured and tested according to the state of the art and to DIN EN ISO 9001.

## Conformité avec les normes

Les boîtes à bornes sont conformes aux normes reprises dans la déclaration de conformité et supplémentaires conformes à la comparables aux IEC Standards IEC 60079-0, IEC 60079-1, IEC 60079-7, IEC 61241-0, IEC 61241-1.

CAN/CSA C22.2 E60079-0-02

CAN/CSA C22.2 E60079-1-02

CAN/CSA C22.2 E60079-7-2003

CAN/CSA C22.2 No 213

CAN/CSA C22.2 No 182.3 M1987

CAN/CSA C22.2 No 94.1-07

94/9 CE: Appareils et systèmes de protection destinés à être utilisés en atmosphère explosible.

Les boîtes à bornes ont été conçues, fabriquées et contrôlées suivant DIN EN ISO 9001.



**Wir / we / nous**

**Cooper Crouse-Hinds GmbH  
Neuer Weg-Nord 49  
D-69412 Eberbach**

erklären in alleiniger Verantwortung, dass die  
*hereby declare in our sole responsibility, that the  
déclarons de notre seule responsabilité, que le*

Mehrfachsteckverbindung eXLink 4-/5-polig  
*multiple plug and socket systems eXLink, 4-/5-pole  
multiple fiches et prises eXLink, à 4-/5-pôles*

⊕ II 2 G Ex de IIC T6 // ⊕ II 2 G Ex ia/ib IIC T6  
⊕ II 2 D Ex tD A21 IP66 T80°C

Typ GHG 57.

auf die sich diese Erklärung bezieht, mit den folgenden Normen oder normativen Dokumenten übereinstimmen.  
*which are the subject of this declaration, are in conformity with the following standards or normative documents.  
auquel cette déclaration se rapporte, est conforme aux normes ou aux documents normatifs suivants.*

Bestimmungen der Richtlinie  
Terms of the directive  
Prescription de la directive

Titel und / oder Nr. sowie Ausgabedatum der Norm.  
Title and / or No. and date of issue of the standard.  
Titre et / ou No. ainsi que date d'émission des  
normes.

94/9/EG: Geräte und Schutzsysteme zur bestimmungs-  
gemäßen Verwendung in explosionsgefährdeten  
Bereichen.

EN 60 079-0: 2006  
EN 60 079-1: 2004  
EN 60 079-7: 2007  
EN 60 079-11: 2007

94/9/EC: Equipment and protective systems intended for  
use in potentially explosive atmospheres.

EN 61 241-0: 2006  
EN 61 241-1: 2004  
EN 60 529: 1991 + A1: 2000  
EN 61 984: 2001  
EN 60 999-1: 2000

94/9/CE: Appareils et systèmes de protection destinés à  
être utilisés en atmosphère explosibles.

2004/108 EG: Elektromagnetische Verträglichkeit  
2004/108 EC: *Electromagnetic compatibility*  
2004/108 CE: *Compatibilité électromagnétique*

EN 60 947-1: 2007

Eberbach, den 04.07.2008

Ort und Datum  
*Place and date  
Lieu et date*

  
i.A. R. Brandel  
Leiter Labor  
*Head of Laboratory  
Chef du dépt. Laboratoire*

  
i.V. H. Huter  
Leiter Approbation  
*Head of Approval office  
Chef du dépt. approbation*

PTB 96 ATEX Q 1 - 4

Zertifizierungsstelle  
*Notified Body of the certification  
Organes Notifié et Compétent*

Physikalisch-Technische Bundesanstalt (0102)  
Bundesallee 100  
D-38116 Braunschweig

Konformitätsbewertungsstelle  
*Notified Body to quality evaluation  
Organes d'attestation de conformité*

Physikalisch-Technische Bundesanstalt (0102)  
Bundesallee 100  
D-38116 Braunschweig

Für den sicheren Betrieb des Betriebsmittels sind die Angaben der zugehörigen Betriebsanleitung zu beachten.  
*For the safe use of this apparatus, the informations given in the accompanying operating instructions must be followed.  
Afin d'assurer le bon fonctionnement de nos appareils, prière de respecter les directives du mode d'emploi correspondent à ceux-ci.*

**eXLink 4-polig Gerätestecker, Flanschsteckdose/  
4-pole Inlet, Flange/  
4 la prise et le prolongateur**



**COOPER** Crouse-Hinds

**Technische Angaben**

Gerätekenzeichnung nach 94/9/EG:	⊕ II 2G Ex de IIC T6/ ⊕ II 2G Ex ia/ib IIC T6 ⊕ II 2D tD A21 IP66 T80°C
nach CSA	Class I, Zone 1 Ex de IIC T6 Class I, Div 2; Gr. A,B,C,D
Zulässige Umgebungstemperatur:	-25°C/-55°C bis +40°C <sup>1)</sup>
EG-Baumusterprüfbescheinigung:	PTB 03 ATEX 1016 X
Bemessungsspannung:	bis 250 V, 50/60 Hz
Bemessungsstrom:	max. 10 A
Anschlussquerschnitt:	AWG 22, AWG 26
Anschlussleitung:	AWG 22/26 Metrofunk
Vibrationsfestigkeit nach EN 60068-2-6 10-150 Hz:	2g / 30 min <sup>2)</sup>
Prüfdrehmomente	
Arretierungsschraube:	1,0 Nm
Einschraubgewinde Steckdose, Gerätestecker:	30 Nm
Überwurfmutter:	2,5 Nm (handfest)

- 1) die besonderen Bedingungen gemäß Prüfschein PTB 03 ATEX 1016 X sind zu beachten.
- 2) Die Hinweise im Kapitel „Montage“ beachten!

**Technical Data**

Apparatus marking acc. to 94/9/EC:	⊕ II 2G Ex de IIC T6/ ⊕ II 2G Ex ia/ib IIC T6 ⊕ II 2D tD A21 IP66 T80°C
acc. CSA	Class I, Zone 1 Ex de IIC T6 Class I, Div 2; Gr. A,B,C,D
Permissible ambient temperature:	-25°C/-55°C to +40 °C <sup>1)</sup>
EC type examination certificate:	PTB 03 ATEX 1016 X
Rated voltage:	up to 250 V, 50/60 Hz
Rated current:	max. 10 A
Terminal cross section:	AWG 22, AWG 26
Cable:	AWG 22/26 Metrofunk
Vibration resistance acc. EN 60068-2-6 10-150 Hz:	2g / 30 min <sup>2)</sup>
Test torques	
Locking screw:	1.0 Nm
Screw-in thread - flange socket, inlet:	30 Nm
coupling nut:	2,5 Nm (by hand)

- 1) observe special requirements accd. certification PTB 03 ATEX 1016 X.
- 2) Follow the instructions in the chapter 'Installation'!

**Caractéristiques techniques**

Marquage de l'appareil selon 94/9/CE:	⊕ II 2G Ex de IIC T6/ ⊕ II 2G Ex ia/ib IIC T6 ⊕ II 2D tD A21 IP66 T80°C
en fonction de CSA	Class I, Zone 1 Ex de IIC T6 Class I, Div 2; Gr. A,B,C,D
Température ambiante admissible:	-25°C/-55°C à +40°C <sup>1)</sup>
Attestation d'examen CE de type:	PTB 03 ATEX 1016 X
Tension nominale:	jusqu'à 250 V, 50/60 Hz
Courant nominal:	max. 10 A
Section raccordement:	AWG 22, AWG 26
Cable:	AWG 22/26 Metrofunk
Résistance aux vibrations selon EN 60068-2-6 10-150 Hz:	2g / 30 min <sup>2)</sup>
Couples de serrage testés	
Vis d'arrêt:	1,0 Nm
Filets de vis de prise à pride, connecteur:	30 Nm
Ecrou (Bien serrer à la main):	2,5 Nm

- 1) Respecter les précautions particulières selon l'attestation d'examen CE de type PTB 03 ATEX 1016 X
- 2) Suivre les instructions du chapitre 'Montage'!

**Sicherheitshinweise**



**Vor dem Öffnen der Druckschraube am Stecker und Kupplung, ist die Spannungsfreiheit sicherzustellen.**

Die Montageanleitung darf nur zusammen mit der ausführlichen Betriebsanleitung „GHG5707001P0001“ (unter [www.ceag.de](http://www.ceag.de) erhältlich) verwendet werden.

Die Benutzerinformationen für „MOOG-Ventile“ sind zu beachten ([www.Moog.com/industrial](http://www.Moog.com/industrial)).

Das Konfektionieren der Steckverbinder darf nur durch Fachkräfte erfolgen.

Die Gewindebohrungen im druckfesten Schutzgehäuse oder Einbaugeräten, müssen den Mindestanforderungen der EN 60079-1, entsprechen.

Die Steckverbindungen eXLink sind nicht für den Einsatz in der Zone 0 oder 20 geeignet.

Zur Sicherstellung des Explosionsschutzes dürfen in die Bohrungen von druckfesten Gehäusen nur Gerätestecker und Flanschsteckdosen aus Metall eingesetzt werden.

Gerätestecker und Flanschsteckdosen aus Metall sind durch geeignete Maßnahmen in das Erdpotential der Gehäuse bzw. Geräte mit einzubeziehen.

Steckverbindung nur in technisch einwandfreiem Zustand sowie bestimmungsgemäß, sicherheits- und gefahrenbewusst unter Beachtung dieser Montage- und Betriebsanleitung montieren und betreiben.

Die unter Spannung stehenden Steckverbindungskomponenten müssen sofort nach dem Trennen mit der Schutzkappe verschlossen werden, damit die Schutzart und damit der Explosionsschutz sichergestellt wird.

**Safety instructions**



**Before opening the pressure screw on the plug and coupler, ensure that it has been isolated from the supply.**

The assembly instructions must be used in conjunction with the detailed operating instructions “GHG5707001P0001” (available from [www.ceag.de](http://www.ceag.de)).

The user information for „MOOG-Ventile“ must to be observed. ([www.Moog.com/industrial](http://www.Moog.com/industrial)).

The connection of plug and socket systems shall only be carried out by qualified personnel.

The threaded holes in the flameproof enclosure shall fulfil the minimum requirements of EN 60079-1.

Plug and socket systems of the type eXLink are not suited for use in zone 0 or 20 areas.

In order to guarantee the explosion protection, only inlets and flange sockets made of metal may be fitted in the boreholes of flameproof enclosures.

The metal flange sockets and inlets shall be incorporated in the earth potential equalization.

They shall be used for their intended purpose and shall be in an undamaged and perfect state.

When opened, the live plug and socket system components shall be sealed immediately after disconnection using the protective cap.

Here it is necessary to ensure that it is closed correctly, otherwise the minimum degree of protection and the explosion protection are no longer guaranteed.

**Instructions de sécurité**



**Avant de relâcher la vis de pression sur la prise et le prolongateur, vérifiez l'absence de tension.**

Utilisez la notice de montage uniquement en association avec les instructions détaillées de service “GHG5707001P0001” (disponibles sur le site [www.ceag.de](http://www.ceag.de)).

Les informations utilisateur pour les „MOOG-Ventile“ doivent être respectées. ([www.Moog.com/industrial](http://www.Moog.com/industrial)).

Seul un personnel qualifié est autorisé à effectuer le branchement électrique des connecteurs mâles-femelles.

Les alésages filetés du boîtier de protection ou appareil à encastrer résistant à la pression doivent satisfaire aux exigences minima de la norme EN 60079-1.

Les connecteurs mâles-femelles eXLink ne conviennent pas pour une utilisation en zone 0 et 20.

Afin de garantir une protection antidéflagrante, seuls des socles connecteurs et des prises de courant à bride métalliques doivent être montés dans les évidements des boîtiers à l'épreuve de la pression.

Les prises à bride aux métal et les socles connecteur aux métal doivent être reliés au même potentiel.

N'utilisez les prises de courant à bride et socles connecteurs qu'avec les fiches et prolongateurs correspondants et en parfait état.

Après déconnexion, les éléments de connexion encore sous tension doivent immédiatement être protégés à l'aide d'obturateurs.



## Handhabung

- A/A1** Den Stecker mit der Führungsnase lagerichtig in die entsprechende Führungsnut der Kupplung bis zum 1. Anschlag einstecken **(B)**.
- B1** Danach den Stecker um ca. 30° nach rechts bis zum Begrenzungsanschlag drehen.
- C** Stecker bis zum Endanschlag mit der Kupplung zusammenstecken.
- D** Die Überwurfmutter des Steckers über die Kupplung schieben und handfest festschrauben.

## Handling

- A/A1** Insert the plug into the coupler until they reach the 1<sup>st</sup> stop. Ensure that the position of the key on the plug corresponds to that of the keyway on the coupler **(B)**.
- B1** Then turn the plug to the right through ca. 30° until it reaches the stop.
- C** Insert plug into coupler until it reaches the final stop.
- D** Slide the coupling nut of the plug over the coupler and tighten well by hand

## Manoeuvre

- A/A1** Introduisez la fiche en positionnant correctement l'ergot de guidage dans la rainure de guidage correspondante du prolongateur jusqu'à la 1<sup>ère</sup> butée **(B)**.
- B1** Ensuite, tournez la fiche d'environ 30° vers la droite jusqu'en butée de limitation.
- C** Assemblez la fiche et le prolongateur jusqu'en butée.
- D** Enfiler l'écrou de la prise sur le prolongateur et bien serrer à la main.

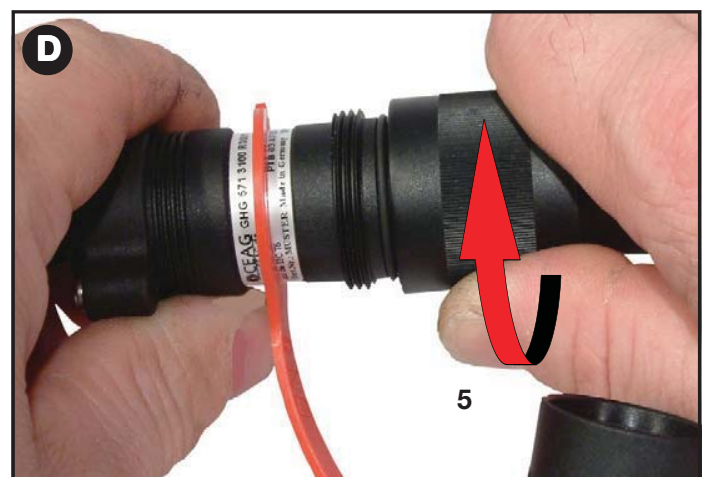
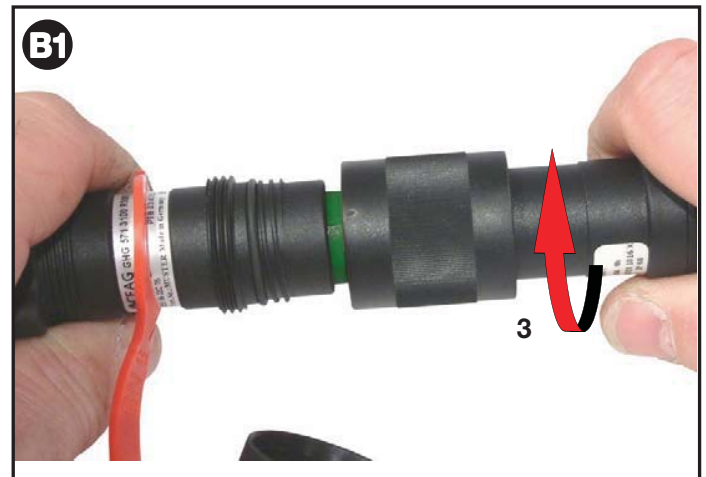
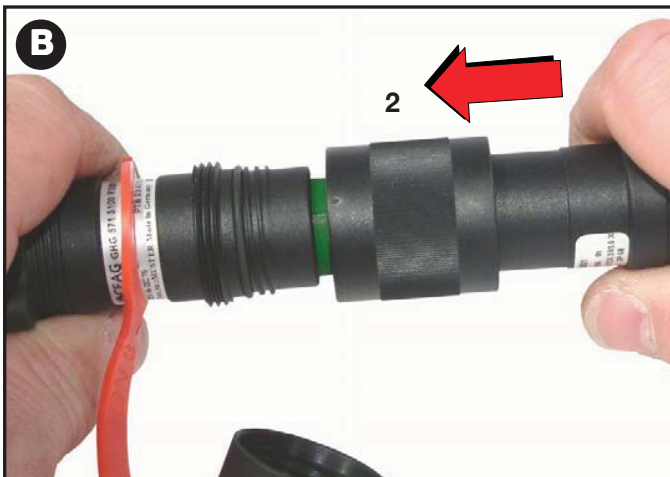
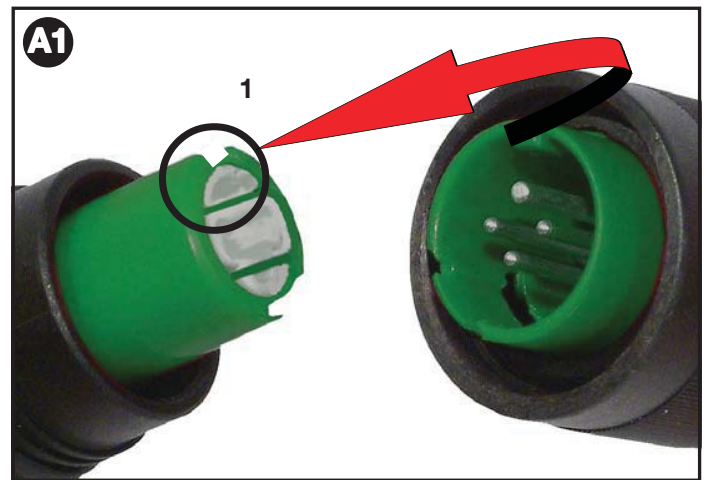
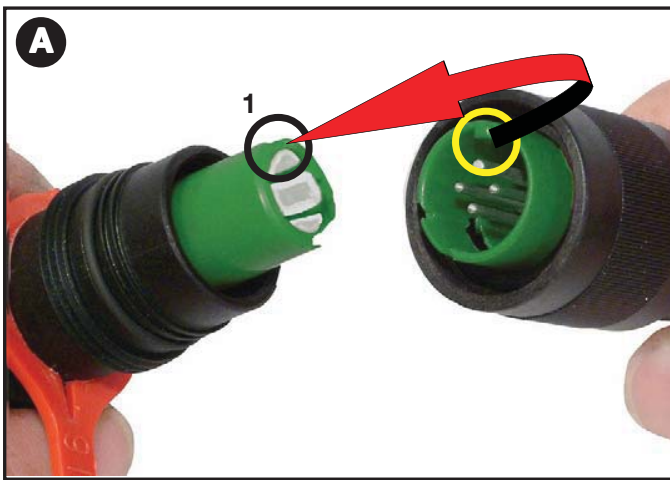

# Montage / Mounting / Montage

**Gerätestecker mit Anschlussleitung**  
**Inlet with connection leads**  
**Socle connecteur avec lignes de raccordement**

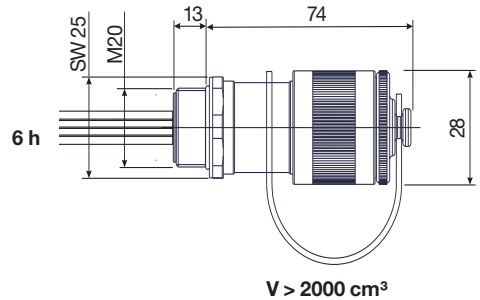
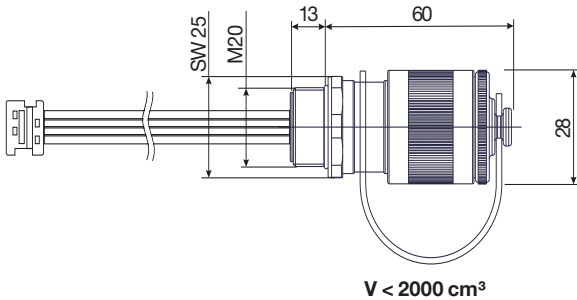

**Flanschsteckdose mit Anschlussleitung**  
**Flange socket with connection leads**  
**Prise à bride avec lignes de raccordement**

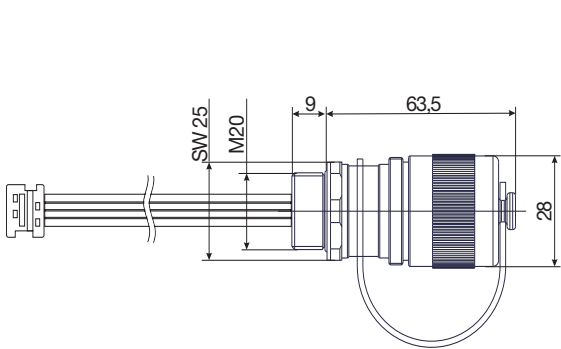

Das Gehäusevolumen bei der Auswahl des Gerätesteckers berücksichtigen.

Observe the flameproof enclosure volume when flange-socket selecting.

Observez le volume de l'enceinte antidéflagrante lors socle connecteur avec sélection.

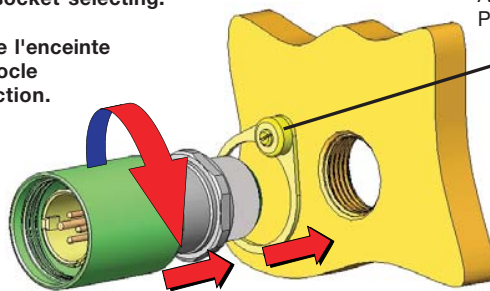

Verdrehungsschutz - optional  
 Anti-torsion protection - optionally  
 Protection anti-torsion - facultatif

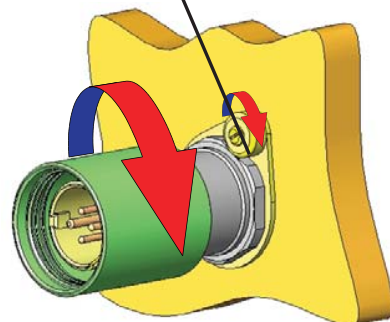

Flanschsteckdosen, oder Gerätestecker müssen durch geeignete Maßnahmen (z.B. Einkleben, Kontern (Prüfdrehmoment 30 Nm) oder Arretieren mit einem Verdrehungsschutz gegen Verdrehen oder Selbstlockern gesichert werden.

Suitable measures shall be applied (e.g. adhesive, locking (Test torques 30 Nm) and retaining with anti-torsion protection) to safeguard screwed-in flange sockets, inlets or angle pieces against twisting or self-loosening.

Une fois vissés, les prises à brides ou socles connecteurs doivent être bloqués par un moyen approprié (par ex. collage, contre-écrou (Couples de serrage testés 30 Nm) et blocage par protection anti-torsion) pour les empêcher de tourner ou de se dévisser.



## Normenkonformität

Das Steckverbindingssystem entspricht den in der Konformitätserklärung aufgeführten Normen und den vergleichbaren IEC Standards IEC 60079-0, IEC 60079-1, IEC 60079-7, IEC 61241-0, IEC 61241-1.  
CAN/CSA C22.2 E60079-0-02  
CAN/CSA C22.2 E60079-1-02  
CAN/CSA C22.2 E60079-7-2003  
CAN/CSA C22.2 No 213  
CAN/CSA C22.2 No 182.3 M1987  
CAN/CSA C22.2 No 94.1-07  
94/9 EG: Geräte und Schutzsysteme zur bestimmungsgemäßen Verwendung in explosionsgefährdeten Bereichen.  
Das Steckverbindingssystem ist gemäß DIN EN ISO 9001 entwickelt, gefertigt und geprüft worden.

## Conformity with standards

The plug and socket system is conform to the standards specified in the EC-Declaration of conformity and additional conform to the comparable IEC Standards IEC 60079-0, IEC 60079-1, IEC 60079-7, IEC 61241-0, IEC 61241-1.  
CAN/CSA C22.2 E60079-0-02  
CAN/CSA C22.2 E60079-1-02  
CAN/CSA C22.2 E60079-7-2003  
CAN/CSA C22.2 No 213  
CAN/CSA C22.2 No 182.3 M1987  
CAN/CSA C22.2 No 94.1-07  
94/9 EC: Equipment and protective systems intended for use in potentially explosive atmospheres.  
It has been designed, manufactured and tested according to the state of the art and to DIN EN ISO 9001.

## Conformité avec les normes

Les boîtes à bornes sont conformes aux normes reprises dans la déclaration de conformité et supplémentaires conformes à la comparables aux IEC Standards IEC 60079-0, IEC 60079-1, IEC 60079-7, IEC 61241-0, IEC 61241-1.  
CAN/CSA C22.2 E60079-0-02  
CAN/CSA C22.2 E60079-1-02  
CAN/CSA C22.2 E60079-7-2003  
CAN/CSA C22.2 No 213  
CAN/CSA C22.2 No 182.3 M1987  
CAN/CSA C22.2 No 94.1-07  
94/9 CE: Appareils et systèmes de protection destinés à être utilisés en atmosphère explosible.  
Les boîtes à bornes ont été conçues, fabriquées et contrôlées suivant DIN EN ISO 9001.

	<b>EG-Konformitätserklärung EC-Declaration of conformity CE-Déclaration de conformité PTB 03 ATEX 1016 X</b>
	GHG 900 1000 P0010 D
<b>Wir / we / nous</b>	<b>Cooper Crouse-Hinds GmbH Neuer Weg-Nord 49 D-69412 Eberbach</b>
erklären in alleiniger Verantwortung, dass die <i>hereby declare in our sole responsibility, that the déclarons de notre seule responsabilité, que le</i>	Mehrfachsteckverbinding eXLink 4-/5-polig <i>multiple plug and socket systems eXLink, 4-/5-pole multiple fiches et prises eXLink, à 4-/5-pôles</i>
Ⓢ II 2 G Ex de IIC T6 // Ⓢ II 2 G Ex ia/Ib IIC T6 Ⓢ II 2 D Ex tD A21 IP66 T80°C	Typ GHG 57.
auf die sich diese Erklärung bezieht, mit den folgenden Normen oder normativen Dokumenten übereinstimmen. <i>which are the subject of this declaration, are in conformity with the following standards or normative documents. auquel cette déclaration se rapporte, est conforme aux normes ou aux documents normatifs suivants.</i>	
Bestimmungen der Richtlinie Terms of the directive Prescription de la directive	Titel und / oder Nr. sowie Ausgabedatum der Norm. Title and / or No. and date of issue of the standard. Titre et / ou No. ainsi que date d'émission des normes.
94/9/EG: Geräte und Schutzsysteme zur bestimmungsgemäßen Verwendung in explosionsgefährdeten Bereichen.	EN 60 079-0: 2006 EN 60 079-1: 2004 EN 60 079-7: 2007 EN 60 079-11: 2007
94/9/EC: Equipment and protective systems intended for use in potentially explosive atmospheres.	EN 61 241-0: 2006 EN 61 241-1: 2004 EN 60 529: 1991 + A1: 2000
94/9/CE: Appareils et systèmes de protection destinés à être utilisés en atmosphère explosibles.	EN 61 984: 2001 EN 60 999-1: 2000
2004/108 EG: Elektromagnetische Verträglichkeit 2004/108 EC: Electromagnetic compatibility 2004/108 CE: Compatibilité électromagnétique	EN 60 947-1: 2007
Eberbach, den 04.07.2008	
Ort und Datum Place and date Lieu et date	I.A. R. Brandel Leiter Labor Head of Laboratory Chef du dépt. Laboratoire
	
	I.V. H. Huter Leiter Approval Head of Approval office Chef du dépt. approbation
	PTB 96 ATEX Q 1 - 4
Zertifizierungsstelle Notified Body of the certification Organes Notifié et Compétent	Physikalisch-Technische Bundesanstalt (0102) Bundesallee 100 D-38116 Braunschweig
Konformitätsbewertungsstelle Notified Body to quality evaluation Organes d'attestation de conformité	Physikalisch-Technische Bundesanstalt (0102) Bundesallee 100 D-38116 Braunschweig
Für den Sicheren Betrieb des Betriebsmittels sind die Angaben der zugehörigen Betriebsanleitung zu beachten. <i>For the safe use of this apparatus, the informations given in the accompanying operating instructions must be followed. Afin d'assurer le bon fonctionnement de nos appareils, prière de respecter les directives du mode d'emploi correspondant à ceux-ci.</i>	
	

## Cooper Crouse-Hinds GmbH

Neuer Weg-Nord 49  
D-69412 Eberbach  
Phone +49 (0) 6271/806-500  
Fax +49 (0) 6271/806-476  
Internet: www.CEAG.de  
E-Mail: info-ex@ceag.de

**eXLink 6+1-polig Stecker, Kupplung/  
6+1-pole plug, coupler /  
6+1 la fiche, prolongateur**



**COOPER** Crouse-Hinds

**Technische Angaben**

Gerätekenzeichnung nach 94/9/EG: II 2 G Ex de IIC T6  
 II 2 G Ex ia/ib IIC T6  
nach CSA Class I, Zone 1 Ex de IIC T6 Class I, Div 2; Gr. A,B,C,D

EG-Baumusterprüfbescheinigung:	PTB 06 ATEX 1031 X
Zulässige Umgebungstemperatur:	-25°C/-55°C bis 40°C <sup>1)</sup>
Bemessungsspannung:	bis 400 V, 50/60 Hz
Bemessungsstrom:	max. 16 A
Leitungseinführung ø:	Standard Optional
Stecker, Kupplung	ø7-11mm ø11-15mm
Anschlussleitung:	LEONI 7x0,75mm <sup>2</sup> , MUD
Anschlussquerschnitt:	1x0,75-1,5mm <sup>2</sup> / 2,5mm <sup>2</sup>
Vibrationsfestigkeit nach EN 60068-2-6 10-150 Hz:	2g / 30 min <sup>2)</sup>
Prüfdrehmomente:	Metall
Arretierungsschraube	1,0 Nm
Einschraubgewinde Steckdose, Gerätestecker	3,5 Nm
Druckschraube	3,5 Nm
Druckschraube	3,5 Nm

**Technical Data**

Apparatus marking acc. to 94/9/EC: II 2 G Ex de IIC T6  
 II 2 G Ex ia/ib IIC T6  
acc. CSA Class I, Zone 1 Ex de IIC T6 Class I, Div 2; Gr. A,B,C,D

EC type examination certificate:	PTB 06 ATEX 1031 X
Permissible ambient temperature:	-25°C/-55°C to +40 °C <sup>1)</sup>
Rated voltage:	up to 400 V, 50/60 Hz
Rated current:	max. 16 A
Cable entry ø:	Standard Optional
Plug, coupler	ø7-11mm ø11-15mm
Cable:	LEONI 7x0,75mm <sup>2</sup> , MUD
Terminal cross section:	1x0,75-1,5mm <sup>2</sup> / 2,5mm <sup>2</sup>
Vibration resistance acc. EN 60068-2-6 10-150 Hz:	2g / 30 min <sup>2)</sup>
Test torques:	
Locking screw	1.0 Nm
Screw-in thread - flange socket, inlet	3.5 Nm
Pressure screw	3.5 Nm
Pressure screw	3.5 Nm

**Caractéristiques techniques**

Marquage de l'appareil selon 94/9/CE: II 2 G Ex de IIC T6  
 II 2 G Ex ia/ib IIC T6  
en fonction de CSA Class I, Zone 1 Ex de IIC T6 Class I, Div 2; Gr. A,B,C,D

Attestation d'examen CE de type:	PTB 06 ATEX 1031 X
Température ambiante admissible:	-25°C/-55°C à +40°C <sup>1)</sup>
Tension nominale:	jusqu'à 400 V, 50/60 Hz
Courant nominal:	max. 16 A
Entrée de câble ø:	Standard Optional
Fiche, Prolongateur	ø7-11mm ø11-15mm
Cable:	LEONI 7x0,75mm <sup>2</sup> , MUD
Section raccordement:	1x0,75-1,5mm <sup>2</sup> / 2,5mm <sup>2</sup>
Résistance aux vibrations selon EN 60068-2-6 10-150 Hz:	2g / 30 min <sup>2)</sup>
Couples de serrage testés:	
Vis d'arrêt	1,0 Nm
Filets de vis de prise à pride, connecteur	3,5 Nm
Vis de serrage	3,5 Nm
Vis de serrage	3,5 Nm

- 1) die besonderen Bedingungen gemäß Prüfschein PTB 03 ATEX 1016 X sind zu beachten.  
2) Die Hinweise im Kapitel „Montage“ beachten!

- 1) observe special requirements accd. certification PTB 03 ATEX 1016 X.  
2) Follow the instructions in the chapter 'Installation

- 1) Respecter les précautions particulières selon l'attestation d'examen CE de type PTB 03 ATEX 1016 X  
2) Suivre les instructions du chapitre 'Montage!

**Sicherheitshinweise**

*Zielgruppen dieser Anleitung sind Elektrofachkräfte und unterwiesene Personen in Anlehnung an die IEC 60079-14.*

*Die Montageanleitung nur zusammen mit der ausführlichen Betriebsanleitung „GHG5707005P0001“ (unter [www.ceag.de](http://www.ceag.de) erhältlich) verwenden.  
Die Benutzerinformationen für „MOOG-Ventile“ sind zu beachten ([www.Moog.com/industrial](http://www.Moog.com/industrial)).*

*Die auf den Geräten angegebene Temperaturklasse und Zündschutzart ist zu beachten.*

*Die Steckverbindung ist nicht für den Einsatz im explosionsgefährdeten Bereich der Zone 0 und Zone 20, 21, 22 gemäß EN 60079-10 geeignet.*

*Steckverbinder unter Last nur mit den Werten der Technischen Daten betreiben.*

*Trennen unter Belastung maximal bis 230 V / 400 V, 10 A möglich.*

*Steckverbindung nur in technisch einwandfreiem Zustand sowie bestimmungsgemäß, sicherheits- und gefahrenbewusst unter Beachtung dieser Montage- und Betriebsanleitung montieren und betreiben.*

*Beachten Sie die nationalen Sicherheits- und Unfallverhütungsvorschriften und die nachfolgenden Sicherheitshinweise in dieser Betriebsanleitung, die wie dieser Text in Kursivschrift gefasst sind!*

**Safety instructions**

*Operations shall be carried out by electricians and suitably personnel trained in hazardous area with knowledge of increased safety explosion protection in accordance with IEC 60079-14.*

*The assembly instructions must be used in conjunction with the detailed operating instructions “GHG5707005P0001” (available from [www.ceag.de](http://www.ceag.de)).  
The user information for „MOOG-Ventile“ must to be observed ([www.Moog.com/industrial](http://www.Moog.com/industrial)).*

*The temperature class and explosion group marked on the terminal boxes have to be observed.*

*The plug and socket system is not suitable for Zone 0 and zone 20, 21, 22 hazardous areas accordance with IEC 60079-10.*

*The plug and socket system may only be connected or disconnected under load acc. to technical data. (230 V / 400 V max. 10 A)*

*These assembly and operating instructions shall be observed when installing and operating the plug and socket connector system. It shall only be used in a technically perfect state and in accordance with the intended purpose while paying attention to the particular safety and hazard aspects.*

*The national safety rules and regulations for the prevention of accidents, as well as the safety instructions included in these operating instructions, that, like this text, are set in italics, shall be observed!*

**Consignes de sécurité**

*Ce mode d'emploi s'adresse aux électriciens et personnes initiées sur base de la norme CEI 60079-14.*

*Utilisez la notice de montage uniquement en association avec les instructions détaillées de service “GHG5707005P0001” (disponibles sur le site [www.ceag.de](http://www.ceag.de) ).  
Les informations utilisateur pour les „MOOG-Ventile“ doivent être respectées ([www.Moog.com/industrial](http://www.Moog.com/industrial)).*

*Le groupe d'explosion et la classe de température marqués sur les appareils devront être respectés.*

*Le connecteur n'est pas conçu pour être utilisé dans les atmosphères explosibles des zones 0 et 20, 21, 22 conformément à CEI 60079-10.*

*Respecter impérativement les valeurs indiquées dans les caractéristiques techniques pour les connecteurs sous charge. Ne séparer qu'à 230 V / 400 V 10 A*

*Monter et utiliser le connecteur seulement s'il présente un état technique parfait, conformément à sa destination, en étant conscient des risques et des mesures de sécurité à appliquer dans le respect d es présentes instructions de montage et de service.*

*Tenir compte des prescriptions nationales en matière de sécurité et de prévention des accidents ainsi que des consignes de sécurité indiquées dans ce mode d'emploi, écrites en italiques comme ce texte !*

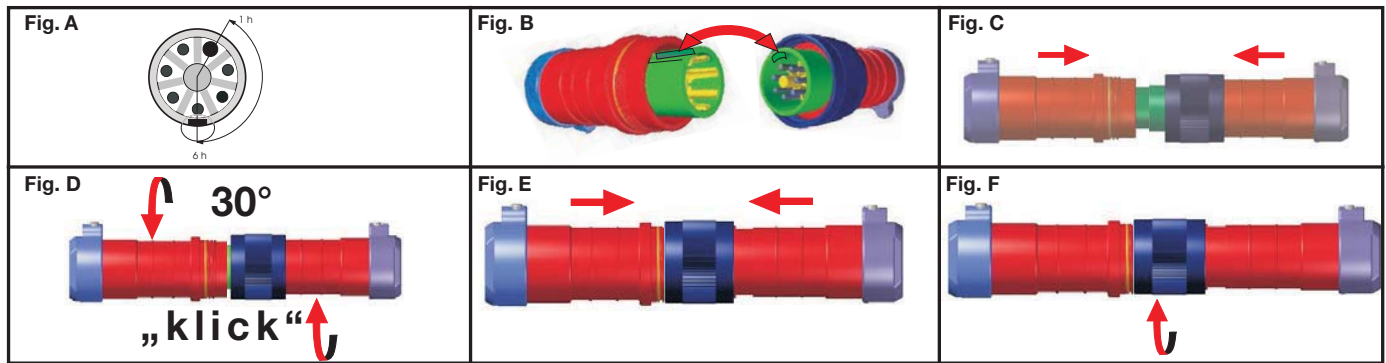

## Verwendung/Eigenschaften

**Die auf den Steckverbindern angegebene Temperaturklasse und Zündschutzart beachten.**

Steckverbindung unter Last nur mit den Werten der Technischen Daten betreiben und trennen.

Die Verantwortung hinsichtlich bestimmungsgemäßer Verwendung der Steckverbindung unter Bezugnahme der in dieser Montage- und Betriebsanleitung vorhandenen Rahmenbedingungen (Technischen Daten) liegt allein beim Betreiber.

Keine Veränderungen bzw. Umbauten an der Steckverbindung vornehmen.

Jede andere Verwendung ist nicht bestimmungsgemäß.

COOPER Crouse-Hinds übernimmt keine Haftung für Schäden, die aus nicht bestimmungsgemäßer Verwendung entstehen.

## Steckverbindung stecken/trennen

**⚠ Die Flanschsteckdosen und Gerätestecker nur mit den zugehörigen unbeschädigten Steckern und Kupplungen betreiben.**

**⚠ Auf gleiche Codierung (Uhrzeit) der Steckverbindung achten.**

**i** Der Winkel zwischen Führungsnase und PE Stift (mit größerem Durchmesser) ergibt die Uhrzeit. (Fig. A)

### Steckverbindung stecken

1. Der Stecker bzw. Gerätestecker mit der Führungsnase lagerichtig in die entsprechende Führungsnute der Kupplung bzw. Flanschsteckdose stecken. (Fig. B)
2. Bis zum 1. Anschlag zusammenstecken. (Fig. C)
3. Stecker bzw. Gerätestecker gegen Kupplung bzw. Flanschsteckdose ca. 30° gegeneinander bis zum Anschlag verdrehen. (Fig. D)
4. Steckverbindung vollständig zusammenstecken. (Fig. E)

**i** Die elektrische Verbindung des Stecksystems ist jetzt hergestellt.

5. Überwurfmutter des Steckers andrücken und festschrauben.

**⚡ IP Schutz und die mechanische Verbindung hergestellt. (Fig. F)**

### Steckverbindung trennen

1. Steckverbindung in umgekehrter Reihenfolge zum Stecken trennen.

**⚠ Bei nicht korrektem Stecken der Steckverbindungskomponenten ist der Explosionsschutz nicht mehr gewährleistet.**

## Use / Properties

**The temperature class and type of protection stated on the apparatus shall be observed.**

The plug and socket system may only be operated and disconnected under load acc. to the technical data.

The sole responsibility with respect to the suitability and proper use of the plug and socket systems with regard to the basic requirements of these instructions (see Technical Data) lies with the operator.

Plug and socket systems shall be checked in accordance with Section 6 of the named instructions, before being put into use.

Modifications or changes to the design of the plug and socket systems are not permitted. Applications other than described are not permitted without COOPER CROUSE-HINDS's prior written consent.

CCH takes no responsibility for damages caused by incorrect use.

## Connection/disconnection of plug and socket

**⚠ The flange sockets and inlets shall only be operated with the associated, undamaged plugs and couplers.**

**⚠ Attention shall be paid that the coding (time setting) of the plugs and sockets is the same.**

**i** The time of day is the angle between the guide lug and the PE pin (larger in diameter). (Fig. A)

### Connecting plug and socket

1. Insert the plug or inlet with the guide lug in the correct position into the respective keyway of the coupler or flange socket. (Fig. B)
2. Insert until 1<sup>st</sup> stop is reached. (Fig. C)
3. Turn plug or inlet through ca. 30° in relation to the coupler or flange socket until the stop is reached. (Fig. D)
4. Join plug and socket completely. (Fig. E)

**i** The electrical connection has now been made.

5. Press the coupling nut of the plug on and screw it tight.

**⚡ The IP degree of protection and the mechanical connection are established by tightening the coupling nut. (Fig. F)**

### Disconnecting plug and socket

1. To disconnect plug and socket, carry out the above actions in the reverse order.

**⚠ When opened, the live plug and socket system components shall be sealed immediately after disconnection using the protective cap.**

## Utilisation / Propriétés

**Observez la classe de température et le type de protection indiqués sur les appareils.**

Respecter impérativement les valeurs indiquées dans les caractéristiques techniques lors de l'utilisation et du débranchement du connecteur.

En cas d'utilisation non conforme de ce dispositif de connexion, par référence aux conditions de base du présent mode d'emploi (caractéristiques techniques), l'exploitant en supporterait seul la responsabilité.

Contrôler le connecteur avant la mise en service conformément aux instructions mentionnées dans la section 6.

Ne pas modifier ou transformer le connecteur.

Utiliser exclusivement des pièces d'origine du fabricant pour les remplacements et réparations.

Toute autre utilisation s'avère non conforme. COOPER Crouse Hinds décline toute responsabilité pour des dommages.

## Branchement/Débranchement du connecteur

**⚠ N'utiliser les prises de courant à bride et les socles connecteurs qu'avec des fiches et prolongateurs compatibles intacts.**

**⚠ Veiller à un codage identique (heure) du connecteur.**

**i** L'angle entre l'ergot de guidage et le contact mâle PE (d'un plus grand diamètre) donne l'heure. (Fig. A)

### Branchement du connecteur

1. Engager dans la bonne position la fiche/le socle connecteur avec l'ergot de guidage dans la rainure de guidage correspondante du prolongateur/de la prise de courant à bride. (Fig. B)
2. Brancher les deux éléments jusqu'à la butée 1
3. Tourner dans des sens contraires, d'env. 30°, la fiche/le socle connecteur et le prolongateur/la prise de courant à bride jusqu'en butée. (Fig. D)
4. Le connecteur mâle-femelle boucher tout à fait. (Fig. E)

**i** Le branchement électrique du système de connexion est maintenant réalisé.

5. Appuyer l'écrou-raccord de la fiche et le visser.

**⚡ Le vissage de l'écrou-raccord a pour effet d'établir la protection IP et la liaison mécanique. (Fig. F)**

### Débranchement du connecteur

1. Débrancher le connecteur dans l'ordre inverse du branchement.

**⚠ Les éléments de connexion conducteurs de tension à l'état ouvert doivent être fermés avec le capuchon dès le débranchement.**

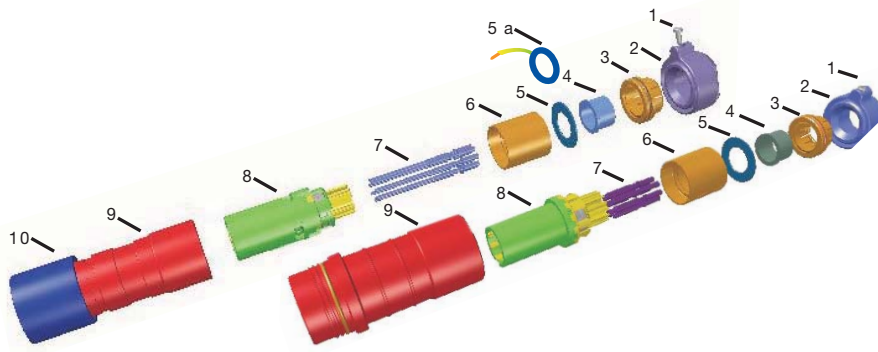

- 1 Arretierschraube
- 2 Druckstück
- 3 Zugentlastung
- 4 Dichtung
- 5 Druckscheibe
- 5a Druckscheibe mt PE
- 6 geteilte Isolierhülse
- 7 Stift / Buchse
- 8 Einsatz
- 9 Hülse
- 10 Überwurfmutter

- 1 Locking screw
- 2 Pressure piece
- 3 Strain relief
- 4 Seal
- 5 Thrust washer
- 5a Thrust washer with PE
- 6 Insulating sleeve divisible
- 7 Plug pins / contact sockets
- 8 Plug/Coupler insert
- 9 Plug/Coupler sleeve
- 10 Coupling nut

- 1 Vis d'arrêt
- 2 Pièce de pression
- 3 Décharge de tension
- 4 Joint
- 5 Rondelle de pression
- 5a Rondelle de pression avec un pe
- 6 Douille isolante
- 7 Contact mâle/femelle
- 8 Bloc de fiche/prolongateur à insérer
- 9 Douille de fiche/prolongateur
- 10 Ecroû-raccord

#### Kupplung

Coupler

Prolongateur

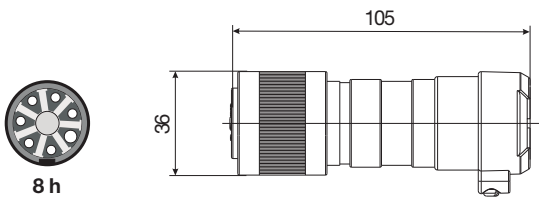

8 h

#### Stecker

Plug

Fiche

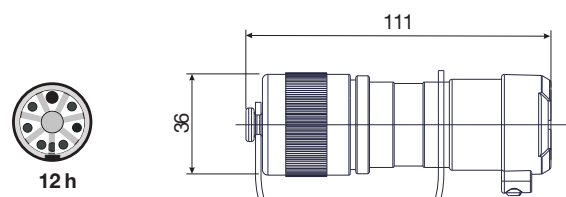

12 h

### Stecker/Kupplung öffnen

1. Eventuell vorhandene Schutzkappe abschrauben.
2. Arretierschraube (1) lösen.
3. Druckstück (2) aus Hülse (9) herausdrehen.
4. Einsatz (8) von vorne aus der Hülse (9) herausdrücken.
5. Dabei Zugentlastung (3), Dichtung (4), Druckscheibe (5), Isolierhülse (6) aus Hülse (9) nach hinten heraus nehmen.
6. Farbring zur Kennzeichnung auf Hülse (9) aufziehen.

### Plug open (Fig. 7.1)

1. Screw down possible existing protective cap. .
2. Loosen locking screw (1).
3. Screw out pressure piece (2) of plug sleeve (9).
4. Press out from front plug insert (8) out of plug sleeve (9).
5. At the same time, remove the strain relief (3), seal (4), thrust washer (5) and insulating sleeve (6) from the plug sleeve (9) from the back.
6. Fit coloured ring used for marking on to the plug sleeve (9).

### Ouverture de la fiche

1. Dévisser le capuchon (si monté) de la fiche.
2. Dévisser la vis d'arrêt (1).
3. Sortir en la tournant la pièce de pression (2) de la douille de fiche (9).
4. Extraire par l'avant le bloc de fiche (8) de la douille de fiche (9).
5. Retirer pendant cette opération par l'arrière la décharge de tension (3), le joint (4), la rondelle de pression (5), la douille isolante (6) de la douille de fiche (9).
6. Monter la bague en couleur comme repère sur la douille de fiche (9).



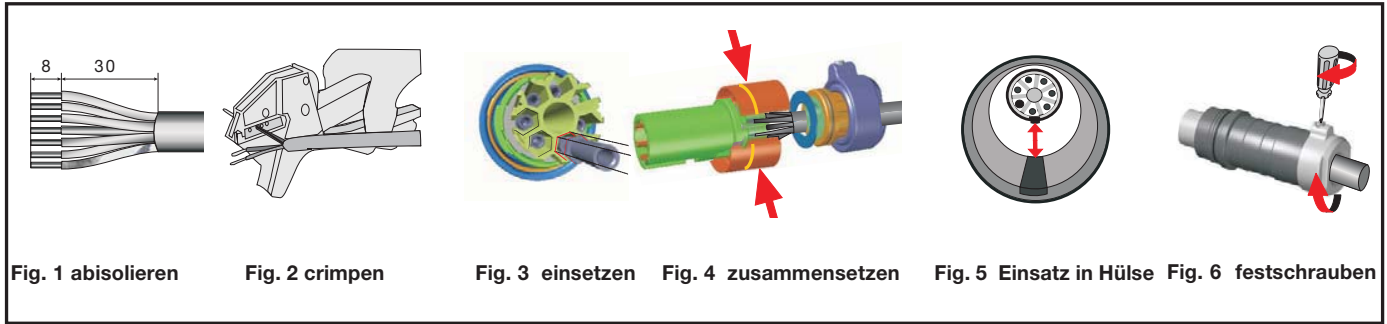

Fig. 1 abisolieren

Fig. 2 crimpen

Fig. 3 einsetzen

Fig. 4 zusammensetzen

Fig. 5 Einsatz in Hülse

Fig. 6 festschrauben

### Leiter mit Stiften / Buchsen verbinden

**⚠** Die Isolation des Leiters muss bis an die Stifte / Buchsen heranreichen. Der Leiter und die Isolation dürfen nicht beschädigt sein.

1. Kabel ca. 30 mm abmanteln.(Fig.1)
2. Leiter des Kabels ca. 8 mm abisolieren.

### Stifte / Buchsen anschließen

1. Leiter in die Anschlussöffnung der Stifte / Buchsen (7) stecken.
2. Alle Leiter mit der Crimpzange (→ Zubehör) ancrimpen (Fig.2).  
oder  
Alle Leiter mit Stiften/Buchsen verlöten und Schrumpfschlauch über jede Lötstelle ziehen.

### Stecker/Kupplung montieren

**⚠** Auch Stifte/Buchsen montieren, die nicht angeschlossen sind.

**!** Die Stifte/Buchsen sind nach dem Eindrücken in den Einsatz nicht mehr demontierbar.

### Connecting conductors to pins

**⚠** The insulation of the conductor shall reach up to the pins. The conductor and the insulation must not be damaged.

1. Strip off ca. 30 mm of cable insulation.(Fig.1)
2. Strip off ca. 8 mm of insulation from cable conductors.

### Crimp plugs/contacts

1. Insert conductor into the connection opening of the plug/contact pin (7).
2. Crimp on all conductors using crimping tool (→ Accessories) [Fig.2] or solder all conductors to plug pins/contact and pull shrink-on sleeve over each solder ring point.

### Assembling plugs/coupler

**⚠** Also assemble plug/coupler pins that are not connected.

**!** Once they have been pressed into the plug/coupler insert, the plug pins cannot be disassembled.

### Raccordement des conducteurs aux contacts mâles/femelles

**⚠** L'isolation du conducteur doit arriver jusqu'aux contacts . Le conducteur et isolementne doit pas être endommagé.

1. Dénuder le câble sur env. 30 mm.(Fig.1)
2. Dénuder les conducteurs du câble sur env. 8 mm.

### Présertir Fiche/Prolongateur

1. Enficher le conducteur dans l'ouverture du contact mâle/femelle (7).
2. Pré-sertir tous les conducteurs avec la pince à sertir (→ accessoire) (Fig.2).  
ou  
braser tous les conducteurs avec les contacts mâles/femelles et enfiler la gaine thermorétractable sur chaque brasure.

### Montage de la fiche/du prolongateur

**⚠** Monter aussi les contacts mâles/femelles non raccordés.

**!** Les contacts mâles/femelles ne peuvent plus être démontés après avoir été pressés dans le bloc de fiche.

1. Druckstück (2), Zugentlastung (3), Dichtung (4) und Druckscheibe (5) auf Kabel aufschieben.
2. Der Stift/die Buchse der Position 7 hat einen größeren Durchmesser. Diesen zuerst in seine Halterung stecken. Alle Stifte / Buchsen (7) bis zum hörbaren Einrasten in die Sechskantführung des Einsatzes (8) drücken (Fig.3).
3. Isolierhülse (6) auseinander ziehen und um die Leiter bis zum Einrasten wieder zusammendrücken (Fig.3).
4. Isolierhülse (6) auf Einsatz (8) schieben.
5. Einsatz (8) mit Führungsnase in die Führungsnut der Hülse (10) stecken (Fig.4).
6. Druckscheibe (5), Dichtung (4), Zugentlastung (3) montieren.
7. Druckstück (2) festschrauben (Drehmoment -> Technische Daten).
8. Arretierschraube (1) festschrauben.

1. Push pressure piece (2), strain relief (3), seal (4) and thrust washer (5) on to cable.
2. The plug/contact pin, Item 7, is larger in diameter. To avoid mistakes, put this into the holder first. Push all the plug pins (7) into the hexagonal keyways of the plug/coupler insert until they engage [Fig.3].
3. Pull the insulating sleeve (6) apart and press the conductors together again until they engage [Fig.3].
4. Push the insulating sleeve (6) on to the plug insert (8).
5. Insert the plug insert (8) with guide lug into the keyway of the plug sleeve (9) [Fig.4].
6. Fit thrust washer (5), seal (4) and strain relief (3).
7. Screw pressure piece (2) tight [torque -> Technical Data]
8. Tighten locking screw (1).

1. Monter la pièce de pression (2), la décharge de tension (3),
2. Le contact mâle/femelle de la position 7 a un plus gros diamètre. Pour éviter toute confusion, enficher celui-ci en premier dans son support. Enfoncer tous les contacts mâles/femelles (7) jusqu'à l'enclenchement dans le guidage hexagonal du bloc de fiche (8) (Fig.3).
3. Ecarter la douille isolante (6) puis la comprimer autour des conducteurs jusqu'à l'enclenchement (Fig.3).
4. Monter la douille isolante (6) sur le bloc de fiche (8).
5. Engager le bloc de fiche (8) avec l'ergot de guidage dans la rainure de guidage (10) de la douille de fiche (Fig.4).
6. Monter la rondelle de pression (5), le joint (4), la décharge de tension (3).
7. Visser la pièce de pression (2) (couple -> Caractéristiques techniques).
8. Visser la vis d'arrêt (1).

## Normenkonformität

Das Steckverbindingssystem entspricht den in der Konformitätserklärung aufgeführten Normen und den vergleichbaren IEC Standards  
IEC 60079-0, IEC 60079-1, IEC 60079-7, IEC 61241-0, IEC 61241-1.  
CAN/CSA C22.2 E60079-0-02  
CAN/CSA C22.2 E60079-1-02  
CAN/CSA C22.2 E60079-7-2003  
CAN/CSA C22.2 No 213  
CAN/CSA C22.2 No 182.3 M1987  
CAN/CSA C22.2 No 94.1-07  
94/9 EG: Geräte und Schutzsysteme zur bestimmungsgemäßen Verwendung in explosionsgefährdeten Bereichen. Das Steckverbindingssystem ist gemäß DIN EN ISO 9001 entwickelt, gefertigt und geprüft worden.

## Conformity with standards

The plug and socket system is conform to the standards specified in the EC-Declaration of conformity and additional conform to the comparable IEC Standards  
IEC 60079-0, IEC 60079-1, IEC 60079-7, IEC 61241-0, IEC 61241-1.  
CAN/CSA C22.2 E60079-0-02  
CAN/CSA C22.2 E60079-1-02  
CAN/CSA C22.2 E60079-7-2003  
CAN/CSA C22.2 No 213  
CAN/CSA C22.2 No 182.3 M1987  
CAN/CSA C22.2 No 94.1-07  
94/9 EC: Equipment and protective systems intended for use in potentially explosive atmospheres. It has been designed, manufactured and tested according to the state of the art and to DIN EN ISO 9001

## Conformité avec les normes

Les boîtes à bornes sont conformes aux normes reprises dans la déclaration de conformité et supplémentaires conformes à la comparables aux IEC Standards  
IEC 60079-0, IEC 60079-1, IEC 60079-7, IEC 61241-0, IEC 61241-1.  
CAN/CSA C22.2 E60079-0-02  
CAN/CSA C22.2 E60079-1-02  
CAN/CSA C22.2 E60079-7-2003  
CAN/CSA C22.2 No 213  
CAN/CSA C22.2 No 182.3 M1987  
CAN/CSA C22.2 No 94.1-07  
94/9 CE: Appareils et systèmes de protection destinés à être utilisés en atmosphère explosible. Les boîtes à bornes ont été conçues, fabriquées et contrôlées suivant DIN EN ISO 9001.

**Wir / we / nous**

**Cooper Crouse-Hinds GmbH  
Neuer Weg-Nord 49  
D-69412 Eberbach**

erklären in alleiniger Verantwortung, dass die  
*hereby declare in our sole responsibility, that the  
déclarons de notre seule responsabilité, que le*

Mehrfachsteckverbindung eXLink 6-/7-polig  
*multiple plug and socket systems eXLink, 6-/7-pole  
multiple fiches et prises eXLink, à 6-/7-pôles*

Ⓢ II 2 G Ex de IIC T6 // Ⓢ II 2 G Ex ia/ib IIC T6

Typ GHG 57.

auf die sich diese Erklärung bezieht, mit den folgenden Normen oder normativen Dokumenten übereinstimmen.  
*which are the subject of this declaration, are in conformity with the following standards or normative documents.  
auquel cette déclaration se rapporte, est conforme aux normes ou aux documents normatifs suivants.*

Bestimmungen der Richtlinie  
Terms of the directive  
Prescription de la directive

Titel und / oder Nr. sowie Ausgabedatum der Norm.  
Title and / or No. and date of issue of the standard.  
Titre et / ou No. ainsi que date d'émission des normes.

94/9/EG: Geräte und Schutzsysteme zur bestimmungs-  
gemäßen Verwendung in explosionsgefährdeten  
Bereichen.

**EN 60 079-0: 2004  
EN 60 079-1: 2004  
EN 60 079-7: 2004  
EN 60 079-11: 2007**

94/9/EC: Equipment and protective systems intended for  
use in potentially explosive atmospheres.

**EN 60 529: 1991 + A1: 2000  
EN 61 984: 2001  
EN 60 999-1: 2000**

94/9/CE: Appareils et systèmes de protection destinés à  
être utilisés en atmosphère explosibles.

2004/108 EG: Elektromagnetische Verträglichkeit  
2004/108 EC: *Electromagnetic compatibility*  
2004/108 CE: *Compatibilité électromagnétique*

**EN 60 947-1: 2007**

Eberbach, den 17.09.09

Ort und Datum  
*Place and date  
Lieu et date*

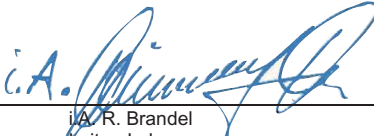
  
i.A. R. Brandel  
Leiter Labor  
*Head of Laboratory  
Chef du dépt. Laboratoire*

  
i.V. H. Huter  
Leiter Approbation  
*Head of Approval office  
Chef du dépt. approbation*

**PTB 96 ATEX Q 1 - 5**

Zertifizierungsstelle  
*Notified Body of the certification  
Organes Notifié et Compétent*

**Physikalisch-Technische Bundesanstalt (0102)  
Bundesallee 100  
D-38116 Braunschweig**

Konformitätsbewertungsstelle  
*Notified Body to quality evaluation  
Organes d'attestation de conformité*

**Physikalisch-Technische Bundesanstalt (0102)  
Bundesallee 100  
D-38116 Braunschweig**

Für den Sicheren Betrieb des Betriebsmittels sind die Angaben der zugehörigen Betriebsanleitung zu beachten.  
*For the safe use of this apparatus, the informations given in the accompanying operating instructions must be followed.  
Afin d'assurer le bon fonctionnement de nos appareils, prière de respecter les directives du mode d'emploi correspondant à ceux-ci.*

**eXLink 6+1-polig Geratestecker, Flanschsteckdose/  
6+1-pole Inlet, Flange/  
6+1 la prise et le prolongateur**



**COOPER Crouse-Hinds**

**Technische Angaben**

Geratekennzeichnung nach 94/9/EG:	Ex II 2G Ex de IIC T6/ Ex II 2G Ex ia/ib IIC T6
nach CSA	Class I, Zone 1 Ex de IIC T6 Class I, Div 2; Gr. A,B,C,D
EG-Baumusterprufbescheinigung:	PTB 06 ATEX 1031 X
Zulassige Umgebungstemperatur:	-25°C/-55°C bis +40°C <sup>1)</sup>
Bemessungsspannung:	bis 400 V, 50/60 Hz
Bemessungsstrom:	max. 16 A
Anschlussleitung:	AWG22 Metrofunk AWG26 Metrofunk
Anschlussquerschnitt:	AWG22, AWG26
Vibrationsfestigkeit nach EN 60068-2-6 10-150 Hz:	2g / 30 min <sup>2)</sup>
Prufdrehmomente:	
Arretierungsschraube:	1,0 Nm
Einschraubgewinde Steckdose, Geratestecker	30 Nm
Uberwurfmutter:	2,5 Nm (handfest)

**Technical Data**

Apparatus marking acc. to 94/9/EC:	Ex II 2G Ex de IIC T6/ Ex II 2G Ex ia/ib IIC T6
acc. CSA	Class I, Zone 1 Ex de IIC T6 Class I, Div 2; Gr. A,B,C,D
EC type examination certificate:	PTB 06 ATEX 1031 X
Permissible ambient temperature:	-25°C/-55°C to +40 °C <sup>1)</sup>
Rated voltage:	up to 400 V, 50/60 Hz
Rated current:	max. 16 A
Cable:	AWG22 Metrofunk AWG26 Metrofunk
Terminal cross section:	AWG22, AWG26
Vibration resistance acc. EN 60068-2-6 10-150 Hz:	2g / 30 min <sup>2)</sup>
Test torques	
Locking screw:	1.0 Nm
Screw-in thread - flange socket, inlet:	30 Nm
coupling nut:	2,5 Nm (by hand)

**Caractéristiques techniques**

Marquage de l'appareil selon 94/9/CE:	Ex II 2G Ex de IIC T6/ Ex II 2G Ex ia/ib IIC T6
en fonction de CSA	Class I, Zone 1 Ex de IIC T6 Class I, Div 2; Gr. A,B,C,D
Attestation d'examen CE de type:	PTB 06 ATEX 1031 X
Température ambiante admissible:	-25°C/-55°C à +40°C <sup>1)</sup>
Tension nominale:	jusqu'à 400 V, 50/60 Hz
Courant nominal:	max. 16 A
Cable:	AWG22 Metrofunk AWG26 Metrofunk
Section raccordement:	AWG22, AWG26
Résistance aux vibrations selon EN 60068-2-6 10-150 Hz:	2g / 30 min <sup>2)</sup>
Couples de serrage testés	
Vis d'arrêt:	1,0 Nm
Filets de vis de prise à pride, connecteur:	30 Nm
Ecrou (Bien serrer à la main):	2,5 Nm

- 1) Die besonderen Bedingungen gema Prufschein PTB 03 ATEX 1016 X sind zu beachten.  
2) Die Hinweise im Kapitel „Montage“ beachten!

- 1) observe special requirements accd. certification PTB 03 ATEX 1016 X.  
2) Follow the instructions in the chapter 'Installation'

- 1) Respecter les precautions particulires selon l'attestation d'examen CE de type PTB 03 ATEX 1016 X  
2) Suivre les instructions du chapitre 'Montage!'

**Sicherheitshinweise**

*Zielgruppen dieser Anleitung sind Elektrofachkrafte und unterwiesene Personen in Anlehnung an die EN/IEC 60079-14.*

*Die Montageanleitung nur zusammen mit der ausfuhrlichen Betriebsanleitung „GHG5707005P0001“ (unter www.ceag.de erhaltlich) verwenden.*

*Die Benutzerinformationen fur „MOOG-Ventile“ sind zu beachten (www.Moog.com/industrial).*

*Das Konfektionieren der Steckverbinder darf nur durch Fachkrafte erfolgen.*

*Die auf den Geraten angegebene Temperaturklasse und Zundschutzart ist zu beachten.*

*Die Steckverbindung ist nicht fur den Einsatz im explosionsgefahrdeten Bereich der Zone 0 und Zone 20, 21, 22 gema EN60079-10 geeignet.*

*Steckverbinder unter Last nur mit den Werten der Technischen Daten betreiben.*

*Trennen unter Belastung maximal bis 230 V / 400 V , 10 A moglich.*

*Geratestecker und Flanschsteckdosen aus Metall sind durch geeignete Manahmen in das Erdpotential der Gehause bzw. Gerate mit einzubeziehen. Steckverbindung nur in technisch einwandfreiem Zustand sowie bestimmungsgema, sicherheits- und gefahrenbewusst unter Beachtung dieser Montage- und Betriebsanleitung montieren und betreiben.*

*Die unter Spannung stehenden Steckverbindungskomponenten mussen sofort nach dem Trennen mit der Schutzkappe verschlossen werden, damit die Schutzart und damit der Explosionschutz sichergestellt wird.*

**Safety instructions**

*Operations shall be carried out by electricians and suitably personnel trained in hazardous area with knowledge of increased safety explosion protection in accordance with IEC 60079-14.*

*The assembly instructions must be used in conjunction with the detailed operating instructions “GHG5707005P0001” (available from www.ceag.de).*

*The user information for „MOOG-Ventile“ must to be observed.*

*The connection of plug and socket systems shall only be carried out by qualified personnel.*

*The temperature class and explosion group marked on the terminal boxes have to be observed.*

*The plug and socket system is not suitable for Zone 0 and zone 20, 21, 22 hazardous areas accordance with EN 60079-10.*

*The plug and socket system may only be connected or disconnected under load acc. to technical data. (230 V / 400 V max. 10 A). The metal flang sockets and inlets shall be incorporated in the earth potential equalization.*

*These assembly and operating instructions shall be observed when installing and operating the plug and socket connector system. It shall only be used in a technically perfect state and in accordance with the intended purpose while paying attention to the particular safety and hazard aspects.*

*The national safety rules and regulations for the prevention of accidents, as well as the safety instructions included in these operating instructions, that, like this text, are set in italics, shall be observed! Here it is necessary to ensure that it is closed correctly, otherwise the minimum degree of protection and the explosion protection are no longer guaranteed.*

**Consignes de securite**

*Ce mode d'emploi s'adresse aux electriciens et personnes inities sur base de la norme CEI 60079-14.*

*Utilisez la notice de montage uniquement en association avec les instructions dtailles de service “GHG5707005P0001” (disponibles sur le site www.ceag.de).*

*Les informations utilisateur pour les „MOOG-Ventile“ doivent tre respectes.*

*Seul un personnel qualifi est autoris  effectuer le branchement electrique des connecteurs mles-femelles.*

*Le groupe d'explosion et la classe de temprature marqus sur les appareils devront tre respects.*

*Le connecteur n'est pas conu pour tre utilis dans les atmosphres explosibles des zones 0 et 20, 21, 22 conformment  CEI 60079-10.*

*Respecter imprativement les valeurs indiques dans les caractristiques techniques pour les connecteurs sous charge. Ne sparer qu' 230 V / 400 V 10 A.*

*Les prises  bride aux mtal et les sockles connecteur aux mtal doivent tre relis au mme potentiel.*

*Monter et utiliser le connecteur seulement s'il prsente un tat technique parfait, conformment  sa destination, en tant conscient des risques et des mesures de scurit  appliquer dans le respect d es prsentes instructions de montage et de service.*

*Tenir compte des prescriptions nationales en matire de scurit et de prvention des accidents ainsi que des consignes de scurit indiques dans ce mode d'emploi, crites en italiques comme ce texte!*

*Aprs dconnexion, les lments de connexion encore sous tension doivent immdiatement tre protgs  l'aide d'obturateurs.*



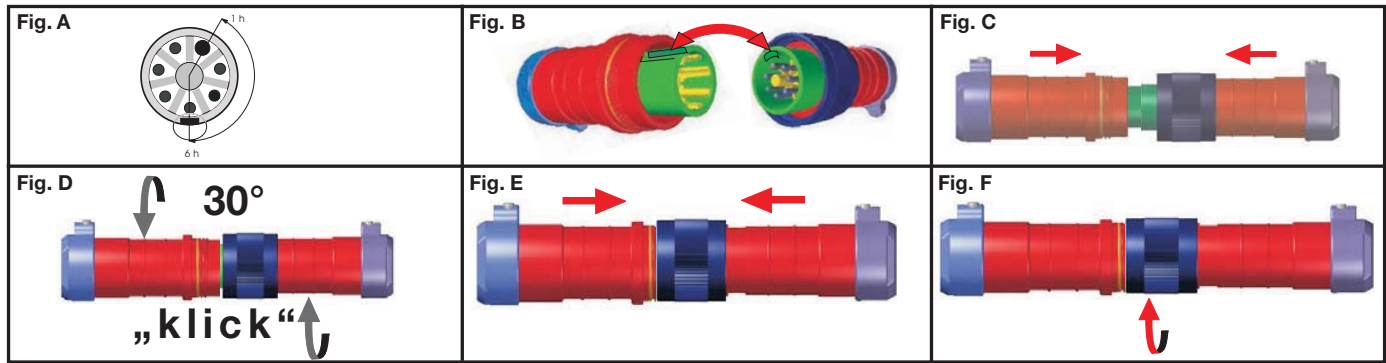

## Steckverbindung stecken/trennen

**⚠ Die Flanschsteckdosen und Gerätestecker nur mit den zugehörigen unbeschädigten Steckern und Kupplungen betreiben.**

**⚠ Auf gleiche Codierung (Uhrzeit) der Steckverbindung achten.**

**i** Der Winkel zwischen Führungsnase und PE Stift (mit größerem Durchmesser) ergibt die Uhrzeit. (Fig. A)

### Steckverbindung stecken

1. Der Stecker bzw. Gerätestecker mit der Führungsnase lagerichtig in die entsprechende Führungsnute der Kupplung bzw. Flanschsteckdose stecken. (Fig. B)
2. Bis zum 1. Anschlag zusammenstecken. (Fig. C)
3. Stecker bzw. Gerätestecker gegen Kupplung bzw. Flanschsteckdose ca. 30° gegeneinander bis zum Anschlag verdrehen. (Fig. D)
4. Steckverbindung vollständig zusammenstecken. (Fig. E)

**i** Die elektrische Verbindung des Stecksystems ist jetzt hergestellt.

5. Überwurfmutter des Steckers andrücken und handfest festschrauben.

**⚠ IP Schutz und die mechanische Verbindung hergestellt. (Fig. F)**

### Steckverbindung trennen

1. Steckverbindung in umgekehrter Reihenfolge zum Stecken trennen.

**⚠ Bei nicht korrektem Stecken der Steckverbindungskomponenten ist der Explosionsschutz nicht mehr gewährleistet.**

## Anschlussleiter von Gerätestecker/Flanschsteckdose vorbereiten

Kabel und Leiter entsprechend den Technischen Daten verwenden.

**⚠ Bei mehr- oder feindrähtigen Leitern die Enden entsprechend den geltenden nationalen und internationalen Vorschriften behandeln (z.B. Verwenden von Aderendhülsen).**

Die ordnungsgemäß abisolierten Leiter des Kabels unter Berücksichtigung einschlägiger Vorschriften anschließen.

Leiteranschluss zur Aufrechterhaltung der Zündschutzart mit besonderer Sorgfalt durchführen.

## Connection/disconnection of plug and socket

**⚠ The flange sockets and inlets shall only be operated with the associated, undamaged plugs and couplers.**

**⚠ Attention shall be paid that the coding (time setting) of the plugs and sockets is the same.**

**i** The time of day is the angle between the guide lug and the PE pin (larger in diameter). (Fig. A)

### Connecting plug and socket

1. Insert the plug or inlet with the guide lug in the correct position into the respective keyway of the coupler or flange socket. (Fig. B)
2. Insert until 1<sup>st</sup> stop is reached. (Fig. C)
3. Turn plug or inlet through ca. 30° in relation to the coupler or flange socket until the stop is reached. (Fig. D)
4. Join plug and socket completely. (Fig. E)

**i** The electrical connection has now been made.  
5. Press the coupling nut of the plug on and screw it tight by hand.

**⚠ The IP degree of protection and the mechanical connection are established by tightening the coupling nut. (Fig. F)**

### Disconnecting plug and socket

1. To disconnect plug and socket, carry out the above actions in the reverse order.

**⚠ When opened, the live plug and socket system components shall be sealed immediately after disconnection using the protective cap.**

## Prepare connection conductors of inlet / flange socket

Only use cables and conductors specified in the Technical Data.

**⚠ With multi-wire or fine-wire connection leads, the ends of the wires shall be treated in accordance with the valid national or international regulations (e.g. the use of wire-end ferrules).**

The insulation of the conductor shall reach up to the plug pins. The conductor must not be damaged

The relevant regulations shall be observed to ensure that the conductors of the cable are stripped off correctly.

The conductors shall be connected with due care to ensure that the degree of protection is maintained.

## Branchement/Débranchement du connecteur

**⚠ N'utiliser les prises de courant à bride et les socles connecteurs qu'avec des fiches et prolongateurs compatibles intacts.**

**⚠ Veiller à un codage identique (heure) du connecteur.**

**i** L'angle entre l'ergot de guidage et le contact mâle PE (d'un plus grand diamètre) donne l'heure. (Fig. A)

### Branchement du connecteur

1. Engager dans la bonne position la fiche/le socle connecteur avec l'ergot de guidage dans la rainure de guidage correspondante du prolongateur/de la prise de courant à bride. (Fig. B)
2. Brancher les deux éléments jusqu'à la butée
3. Tourner dans des sens contraires, d'env. 30°, la fiche/le socle connecteur et le prolongateur/la prise de courant à bride jusqu'en butée. (Fig. D)
4. Le connecteur mâle-femelle boucher tout à fait. (Fig. E)

**i** Le branchement électrique du système de connexion est maintenant réalisé.

5. Appuyer l'écrou-raccord de la fiche et le visser. (Bien serrer à la main).

**⚠ Le vissage de l'écrou-raccord a pour effet d'établir la protection IP et la liaison mécanique. (Fig. F)**

### Débranchement du connecteur

1. Débrancher le connecteur dans l'ordre inverse du branchement.

**⚠ Les éléments de connexion conducteurs de tension à l'état ouvert doivent être fermés avec le capuchon dès le débranchement.**

## Préparation conducteurs de raccordement du socle connecteur / de la prise de courant à bride

Utiliser les câbles et les conducteurs conformément aux Caractéristiques techniques.

**⚠ Avec des conducteurs multifilaires ou à fils fins, traiter les extrémités conformément aux directives nationales et internationales (par ex. en utilisant des embouts).**

Raccorder les conducteurs correctement isolés du câble en respectant les directives correspondantes.

Effectuer le raccordement du conducteur avec beaucoup de soin pour garantir la protection contre les explosions.

## Gerätestecker / Flanschsteckdose einschrauben

! Gerätestecker bzw. Flanschsteckdose nur in die dafür vorgesehene Gehäuse einbauen. Das Gehäusevolumen bei der Auswahl des Gerätesteckers berücksichtigen.

! Die Gewindebohrungen im druckfesten Schutzgehäuse oder Einbaugeräten, müssen den Mindestanforderungen der EN 60079-1, entsprechen.

! Zur Sicherstellung des Explosions-schutzes in die Bohrungen von druckfesten Gehäusen nur Gerätestecker und Flanschsteckdosen aus Metall mit der geeigneten Zündschutzart verwenden.

Die Einschraubgewinde dürfen nicht verschmutzt oder beschädigt sein.

Nur die im Gerätestecker bzw. in der Flanschsteckdose vorhandenen Dichteinsätze verwenden.

Beim Einschrauben der Gerätestecker bzw. der Flanschsteckdosen auf die angeschlossenen Leitungen bzw. Adern achten, damit keine Beschädigung der Isolation durch das Einschrauben entsteht.

! Die Einschraubkomponenten sind so fest einzuschrauben, dass eine korrekte Dichtwirkung gewährleistet ist. (Prüfdrehmoment siehe Technische Daten).

! Die Gerätestecker und Flanschsteckdosen aus Metall in das Erdpotential mit einbeziehen.

Vor dem Stecken sicherstellen, dass Gerätestecker und Flanschsteckdosen nicht beschädigt sind.

1. Gerätestecker bzw. Flanschsteckdose mit Verdrehenschutz einschrauben (Prüfdrehmoment -> Technische Daten).
2. Verdrehenschutzschraube festdrehen.
3. Gerätestecker bzw. Flanschsteckdosen durch kontern sichern.  
Den Gerätestecker nicht durch verkleben gegen Lösen sichern, da sonst Funktionsstörungen auftreten können.

## Screw in inlet / flange socket

! Inlets or flange sockets shall only be built into enclosures intended for this purpose. Observe the flameproof enclosure volume when flange-socket selecting.

! The threaded holes in the flameproof enclosure shall fulfil the minimum requirements of EN 60079-1.

! To ensure the explosion protection, only fit inlets and flange sockets made of metal in the appropriate type of protection into the threaded holes of flameproof enclosures.

The screw-in thread must not be dirty or damaged.

Only use the seal inserts provided in the inlet or flange socket.

When screwing in the inlet or flange socket, pay attention to the connected conductors to ensure that the insulation is not damaged in the process.

! The screw-in components shall be tightened down in such a way that they are properly sealed (see Technical Data for test torque).

! The inlets and flange sockets shall be incorporated in the earth potential.

Before use, ensure that inlets and flange sockets are not damaged.

1. Fit inlet or flange socket with anti-twist protection, (test torque -> Technical Data).
2. Tighten anti-twist screw.
3. Fit inlet or flange socket with anti-twist protection (7), (test torque -> Technical Data).

## Vissage du connecteur / de la prise de courant à bride

! Ne monter le socle connecteur ou la prise de courant à bride que dans les boîtiers prévus à cet effet. Observez le volume de l'enceinte antidéflagrante lors socle connecteur avec sélection.

! Les alésages filetés du boîtier de protection ou appareil à encastrer résistant à la pression doivent satisfaire aux exigences minima de la norme EN 60079-1.

! Pour garantir la protection contre les explosions, n'utiliser dans les orifices des boîtiers résistant à la pression que des socles connecteurs et des prises de courant à bride en métal, présentant le type de protection contre les explosions approprié.

Les filetages ne doivent pas être sales ou endommagés.

N'utiliser que les éléments d'étanchéité disponibles dans le socle connecteur ou la prise de courant à bride.

En vissant le socle connecteur ou la prise de courant à bride sur le câble ou le fil connecté, veiller à ne pas endommager l'isolation.

! Les éléments de vissage doivent être vissés avec un couple assurant une bonne étanchéité. (Couples de contrôle voir les Caractéristiques techniques)

! Intégrer les socles connecteurs et les prises de courant à bride en métal dans le potentiel terrestre.

Avant la connexion, s'assurer que les socles connecteurs et les prises de courant à bride sont en bon état.

1. Visser le socle connecteur ou la prise de courant à bride avec la protection antitortion (Couples de contrôle -> Caractéristiques techniques).
2. Serrer à fond la vis de protection antitortion.
3. Bloquer le socle connecteur ou la prise de courant à bride par contre-écrou.  
Ne pas coller le socle connecteur pour l'empêcher de se desserrer, cela risquerait d'entraîner des dysfonctionnements.

### Gerätestecker mit Anschlussleitung Inlet with connection leads Socle connecteur avec lignes de raccordement

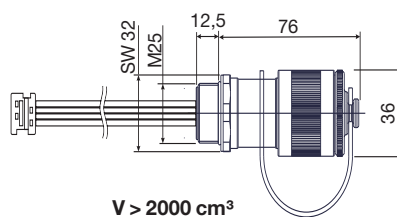
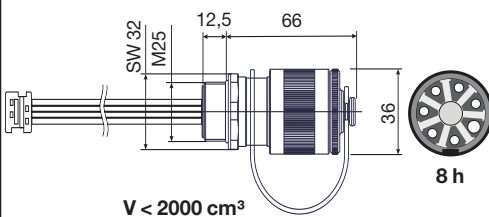

### Flanschsteckdose mit Anschlussleitung Flange socket with connection leads Prise à bride avec lignes de raccordement

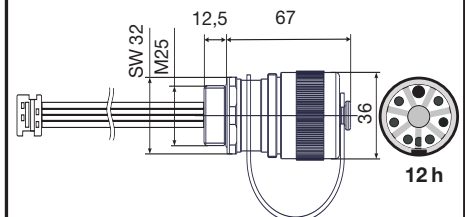

! Das Gehäusevolumen bei der Auswahl des Gerätesteckers berücksichtigen.

Observe the flameproof enclosure volume when flange-socket selecting.

Observez le volume de l'enceinte antidéflagrante lors socle connecteur avec sélection.

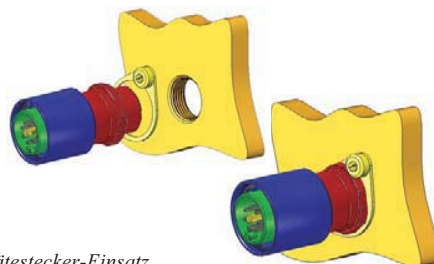

- 1 Überwurfmutter  
Ecrou-raccord  
Ecrou-raccord
- 2 Gerätestecker-Hülse  
Douille du socle connecteur  
Douille du socle connecteur
- 3 Anschlusskabel  
Câble de raccordement  
Câble de raccordement

- 4 Gerätestecker-Einsatz  
Bloc de socle connecteur  
Bloc de socle connecteur
- 5 Flanschsteckdosen Hülse  
Douille de la prise de courant à bride  
Douille de la prise de courant à bride
- 6 Flanschsteckdosen-Einsatz  
Bloc de prise de courant à bride  
Bloc de prise de courant à bride

## Normenkonformität

Das Steckverbindingssystem entspricht den in der Konformitätserklärung aufgeführten Normen und den vergleichbaren IEC Standards IEC 60079-0, IEC 60079-1, IEC 60079-7, IEC 61241-0, IEC 61241-1.  
CAN/CSA C22.2 E60079-0-02  
CAN/CSA C22.2 E60079-1-02  
CAN/CSA C22.2 E60079-7-2003  
CAN/CSA C22.2 No 213  
CAN/CSA C22.2 No 182.3 M1987  
CAN/CSA C22.2 No 94.1-07  
94/9 EG: Geräte und Schutzsysteme zur bestimmungsgemäßen Verwendung in explosionsgefährdeten Bereichen.  
Das Steckverbindingssystem ist gemäß DIN EN ISO 9001 entwickelt, gefertigt und geprüft worden.

## Conformity with standards

The plug and socket system is conform to the standards specified in the EC-Declaration of conformity and additional conform to the comparable IEC Standards IEC 60079-0, IEC 60079-1, IEC 60079-7, IEC 61241-0, IEC 61241-1.  
CAN/CSA C22.2 E60079-0-02  
CAN/CSA C22.2 E60079-1-02  
CAN/CSA C22.2 E60079-7-2003  
CAN/CSA C22.2 No 213  
CAN/CSA C22.2 No 182.3 M1987  
CAN/CSA C22.2 No 94.1-07  
94/9 EC: Equipment and protective systems intended for use in potentially explosive atmospheres.  
It has been designed, manufactured and tested according to the state of the art and to DIN EN ISO 9001.

## Conformité avec les normes

Les boîtes à bornes sont conformes aux normes reprises dans la déclaration de conformité et supplémentaires conformes à la comparables aux IEC Standards IEC 60079-0, IEC 60079-1, IEC 60079-7, IEC 61241-0, IEC 61241-1.  
CAN/CSA C22.2 E60079-0-02  
CAN/CSA C22.2 E60079-1-02  
CAN/CSA C22.2 E60079-7-2003  
CAN/CSA C22.2 No 213  
CAN/CSA C22.2 No 182.3 M1987  
CAN/CSA C22.2 No 94.1-07  
94/9 CE: Appareils et systèmes de protection destinés à être utilisés en atmosphère explosible.  
Les boîtes à bornes ont été conçues, fabriquées et contrôlées suivant DIN EN ISO 9001.

	<b>EG-Konformitätserklärung EC-Declaration of conformity CE-Déclaration de conformité PTB 06 ATEX 1031 X</b>
	GHG 900 1000 P0048 B
<b>Wir / we / nous</b>	<b>Cooper Crouse-Hinds GmbH Neuer Weg-Nord 49 D-69412 Eberbach</b>
erklären in alleiniger Verantwortung, dass die <i>hereby declare in our sole responsibility, that the déclarons de notre seule responsabilité, que le</i>	Mehrfachsteckverbinding eXLink 6-/7-polig <i>multiple plug and socket systems eXLink, 6-/7-pole multiple fiches et prises eXLink, à 6-/7-pôles</i>
II 2 G Ex de IIC T6 // II 2 G Ex ia/ib IIC T6	Typ GHG 57.
auf die sich diese Erklärung bezieht, mit den folgenden Normen oder normativen Dokumenten übereinstimmen. <i>which are the subject of this declaration, are in conformity with the following standards or normative documents. auquel cette déclaration se rapporte, est conforme aux normes ou aux documents normatifs suivants.</i>	
Bestimmungen der Richtlinie Terms of the directive Prescription de la directive	Titel und / oder Nr. sowie Ausgabedatum der Norm. Title and / or No. and date of issue of the standard. Titre et / ou No. ainsi que date d'émission des normes.
94/9/EG: Geräte und Schutzsysteme zur bestimmungsgemäßen Verwendung in explosionsgefährdeten Bereichen.	EN 60 079-0: 2004 EN 60 079-1: 2004 EN 60 079-7: 2004 EN 60 079-11: 2007
94/9/EC: Equipment and protective systems intended for use in potentially explosive atmospheres.	EN 60 529: 1991 + A1: 2000 EN 61 984: 2001 EN 60 999-1: 2000
94/9/CE: Appareils et systèmes de protection destinés à être utilisés en atmosphère explosibles.	
2004/108 EG: Elektromagnetische Verträglichkeit 2004/108 EC: Electromagnetic compatibility 2004/108 CE: Compatibilité électromagnétique	EN 60 947-1: 2007
Eberbach, den 17.09.09	 i.v. 
Ort und Datum Place and date Lieu et date	J.A. Brandel Leiter Labor Head of Laboratory Chef du dépt. Laboratoire
	i.v. Hüter Leiter Approval Head of Approval office Chef du dépt. approbation
	PTB 96 ATEX Q 1 - 5
Zertifizierungsstelle Notified Body of the certification Organes Notifié et Compétent	Physikalisch-Technische Bundesanstalt (0102) Bundesallee 100 D-38116 Braunschweig
Konformitätsbewertungsstelle Notified Body to quality evaluation Organes d'attestation de conformité	Physikalisch-Technische Bundesanstalt (0102) Bundesallee 100 D-38116 Braunschweig
Für den sicheren Betrieb des Betriebsmittels sind die Angaben der zugehörigen Betriebsanleitung zu beachten. <i>For the safe use of this apparatus, the informations given in the accompanying operating instructions must be followed. Afin d'assurer le bon fonctionnement de nos appareils, prière de respecter les directives du mode d'emploi correspondant à ceux-ci.</i>	
	

## Cooper Crouse-Hinds GmbH

Neuer Weg-Nord 49  
D-69412 Eberbach  
Phone +49 (0) 6271/806-500  
Fax +49 (0) 6271/806-476  
Internet: www.CEAG.de  
E-Mail: info-ex@ceag.de



# TAKE A CLOSER LOOK.

Moog designs a range of products that complement the performance of those featured in this document. Visit our website for more information and the Moog facility nearest you.

**Argentina**  
+54 11 4326 5916  
info.argentina@moog.com

**Australia**  
+61 3 9561 6044  
info.australia@moog.com

**Brazil**  
+55 11 3572 0400  
info.brazil@moog.com

**Canada**  
+1 716 652 2000  
info.canada@moog.com

**China**  
+86 21 2893 1600  
info.china@moog.com

**Finland**  
+358 10 422 1840  
info.finland@moog.com

**France**  
+33 1 4560 7000  
info.france@moog.com

**Germany**  
+49 7031 622 0  
info.germany@moog.com

**Hong Kong**  
+852 2 635 3200  
info.hongkong@moog.com

**India**  
+91 80 4057 6605  
info.india@moog.com

**Ireland**  
+353 21 451 9000  
info.ireland@moog.com

**Italy**  
+39 0332 421 111  
info.italy@moog.com

**Japan**  
+81 46 355 3767  
info.japan@moog.com

**Korea**  
+82 31 764 6711  
info.korea@moog.com

**Luxembourg**  
+352 40 46 401  
info.luxembourg@moog.com

**The Netherlands**  
+31 252 462 000  
info.thenetherlands@moog.com

**Norway**  
+47 6494 1948  
info.norway@moog.com

**Russia**  
+7 8 31 713 1811  
info.russia@moog.com

**Singapore**  
+65 677 36238  
info.singapore@moog.com

**South Africa**  
+27 12 653 6768  
info.southafrica@moog.com

**Spain**  
+34 902 133 240  
info.spain@moog.com

**Sweden**  
+46 31 680 060  
info.sweden@moog.com

**Switzerland**  
+41 71 394 5010  
info.switzerland@moog.com

**United Kingdom**  
+44 168 429 6600  
info.uk@moog.com

**USA**  
+1 716 652 2000  
info.usa@moog.com

[www.moog.com/industrial](http://www.moog.com/industrial)

Moog is registered trademark of Moog Inc. and its subsidiaries. All trademarks as indicated herein are the property of Moog Inc. and its subsidiaries.  
© 2010 Moog GmbH. All rights reserved. All changes reserved.

Moog Literature Name  
Rev. -, May 2012, CDS29577-en