

## G122-828 Velocity and Pressure (VP) Controller

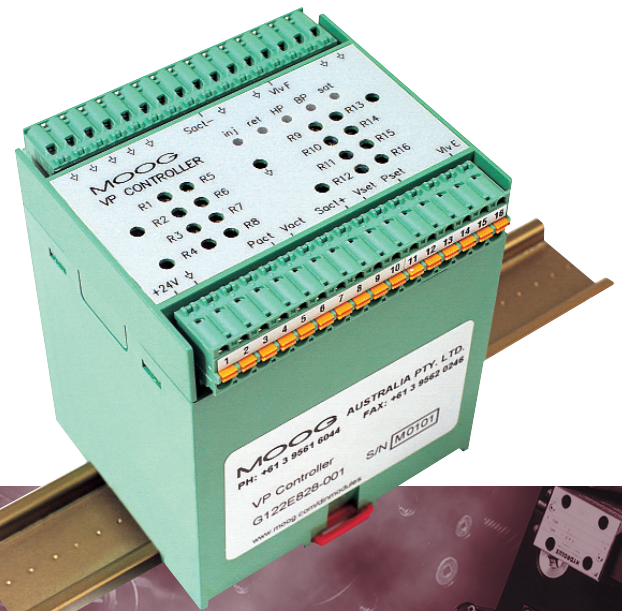

### DESCRIPTION

The Moog G122-828 VP Controller, combined with a Moog servo valve, a position or velocity transducer and a pressure transducer, will provide closed loop control of the injection cycle of a plastic injection molding machine.

The functions controlled during the cycle are:

- Injection speed
- Injection pressure limiting
- Hold pressure during setting
- Back pressure during plasticising

Retract speed during decompression is controlled open loop.

Closed loop control of the critical injection speed and pressures ensures precise repeatability of mold fill and so consistent and high quality machine output. Variations in material characteristics, machine hydraulic pressure, mold temperature, screw clearances, etc, do not result in the normally observed variations in part quality. Consistent and repeatable inject speed, hold pressure and back pressure dramatically reduce the influence of these variables.

The VP Controller is housed in a compact DIN rail mounting enclosure and requires a 24V DC supply.

### FEATURES

- Improved yield
- Higher quality parts
- Set once, no further adjustments needed
- Low cost
- Moog quality and reliability
- Compact DIN rail housing
- Convenient front panel controls, test points and indicators

## SPECIFICATIONS

### Logic inputs: Inject, hold pressure, back pressure and retract

- On at 10 V
- Off at 5 V
- Max 28 V
- 5.1 mA @ 24 V

### Valve output: 0 to ± 10 V @ ± 2 mA max

- Short circuit and over voltage protected

### Monitor signal outputs:

- S-act+ 0 to +10 V
- S-act - 0 to -10 V
- P-act 0 to +10 V
- V-act 0 to +10 V
- 2mA max, short circuit and over-voltage protected

### Front panel test points:

- Wipers of R2, 4, 12 & 13 and 0 V reference

### Front panel indicators:

- inj (inject) – green
- HP (hold pressure) – green
- BP (back pressure) – green
- ret (retract) – green
- sat (valve saturated) – yellow

### Front panel trimpots:

- |                                |                             |
|--------------------------------|-----------------------------|
| R1 velocity sensitivity        | R9 hold pressure I gain     |
| R2 actual pressure zero        | R10 back pressure P gain    |
| R3 actual pressure sensitivity | R11 back pressure I gain    |
| R4 hold pressure zero          | R12 back pressure zero      |
| R5 hold pressure balance       | R13 retract adjust          |
| R6 voltage distributor P gain  | R14 integral delay time     |
| R7 voltage distributor I gain  | R15 pressure limiter P gain |
| R8 hold pressure P gain        | R16 pressure limiter I gain |

### P-set signal input:

- Pin 13** Rin = 100 kOhm  
Vin = 0 to +10 V

### V-set signal input:

- Pin 11** Rin = 10 kOhm  
Vin = 0 to +10 V

### P-act signal input:

- Pin 4** Rin = 15 kOhm  
Vin = 0 to +100 mV

### S-act signal input:

- Pin 8, voltage** J404 made  
Rin = 100 kOhm  
Vin = +10 to 0 V  
Vin must decrease during injection

### V-act signal input:

- Pin 8, frequency** J421 made  
full scale = 1.8 kHz  
mark space ratio = 50%  
Rin = 2 kOhm pull up to +15 V

### S-act signal input:

- Pin 9** Rin = 100 kOhm  
Vin = -10 to 0 V

### Pressure transducer: +5 V ± 0.25 V @ 50 mA max supply, Pin 3

### Valve supply:

- Internally supplied from pin 1
- 300 mA max output

### Supply:

- 24V nominal, 22 to 28 V
- 130 mA @ 24 V, sat LED on

### Mounting:

- DIN rail to EN50002
- Housing IP40
- Terminal block IP20

### Temperature:

- 0 to +40°C

### Dimensions:

- 90 L x 85 W x 108 H

### Weight:

- 316 gm

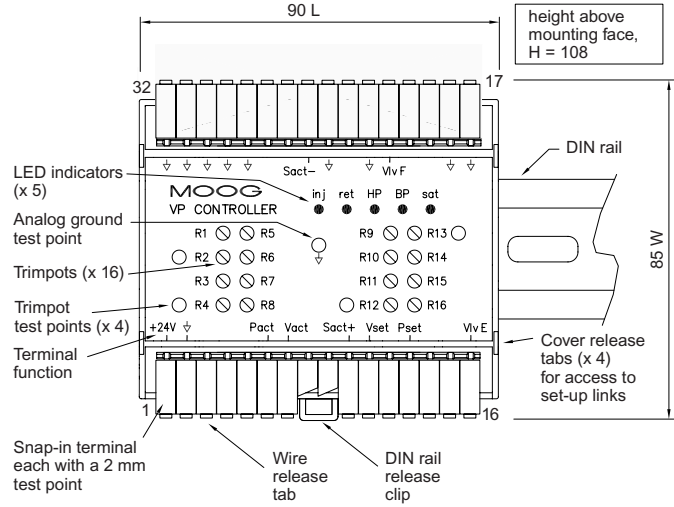

## CYCLE DESCRIPTION

Refer to the timing diagram below and the Operating detail drawings on page 4.

**Inject:** At the start of the cycle the machine PLC sets the INJECT logic input true and outputs an analog voltage V-set, to set the inject speed. It also outputs an analog voltage P-set, which sets the upper limit of the inject pressure. As soon as the actual inject pressure reaches the P-set value, the speed control is suppressed by the pressure control and the rest of the inject part of the cycle is at constant pressure. The pressure will normally rise to this limit when the mold is full and the inject actuator can no longer move forward.

**Hold Pressure:** This part of the cycle maintains a constant pressure on the part, setting in the mold. The machine PLC now removes the INJECT logic input and sets HOLD PRESSURE true. At the same time it adjusts the P-set analog value to the required hold pressure.

**Back Pressure:** This part of the cycle maintains a constant pressure in the rear of the injection actuator to ensure even plasticising.

The machine PLC removes the HOLD PRESSURE logic signal and sets the BACK PRESSURE logic signal true. It adjusts the P-set analog signal to the required pressure and the closed loop holds the oil pressure at that value as the screw rotates and forces the inject actuator back.

**Retract:** After plasticising, the screw is pulled back to stop inject nozzle drool.

The machine PLC removes the BACK PRESSURE logic signal and sets the RETRACT logic signal true. The machine also pressurises the front of the inject actuator to pull back the screw. Oil flow out of the back of the actuator is controlled open loop by the servo valve. The command to the servo valve can come from V-set, or R13 on the VP Controller, or both.

## CYCLE TIMING DIAGRAM

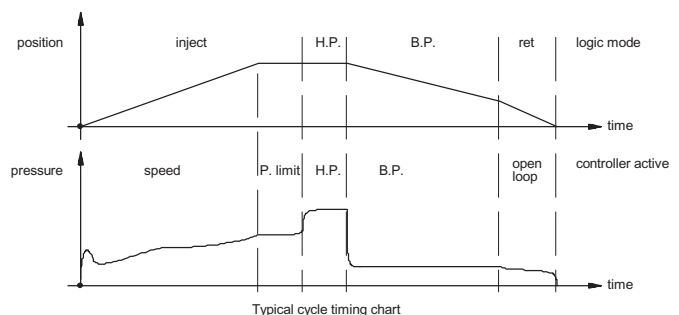

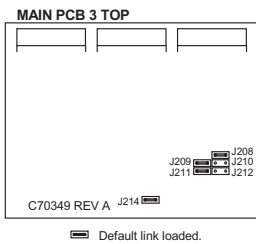
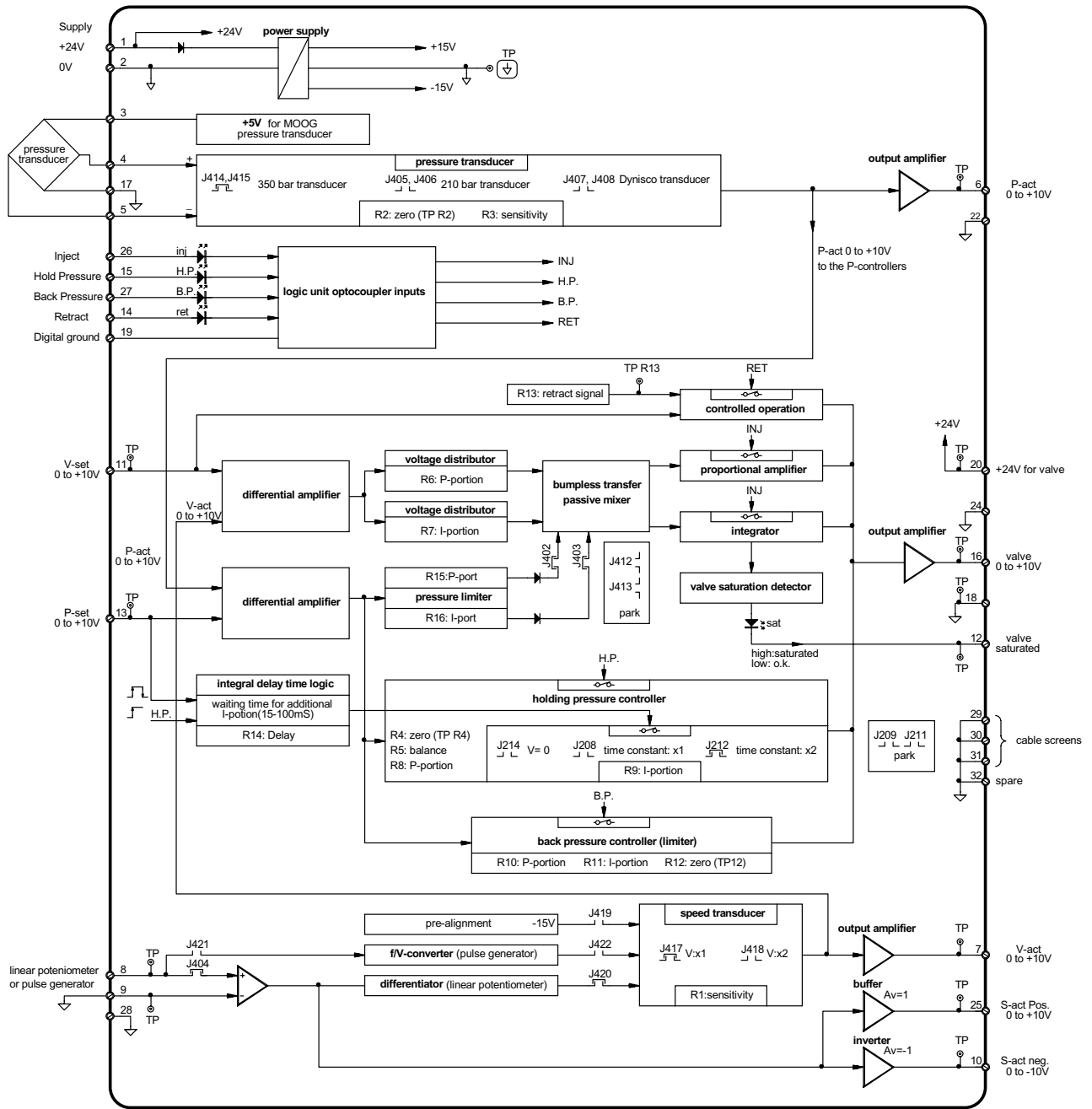

Link	Default	Function
J208	✓	Hold pressure controller integrating capacitor 470nF
J209	✓	Spare
J210		Hold pressure controller integrating capacitor 100nF
J211	✓	Spare
J212		Hold pressure controller integrating capacitor 220nF
J214	✓	Hold pressure controller integrator disable

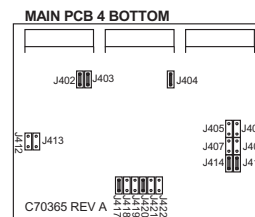

Link	Default	Function
J402	✓	Pressure limiter P enable
J403	✓	Pressure limiter I enable
J404	✓	Velocity signal from linear pot
J405		Pressure measuring amp 210 bar
J406		Pressure measuring amp 210 bar
J407		Pressure measuring amp Dynisco
J408		Pressure measuring amp Dynisco
J412		Spare for J402
J413		Spare for J403
J414	✓	Pressure measuring amp 350 bar
J415	✓	Pressure measuring amp 350bar
J417	✓	Velocity measuring amp low gain V=1
J418		Velocity measuring amp high gain V=2
J419		Velocity signal offset
J420	✓	Velocity signal from linear pot
J421		Velocity signal from pulse pick up
J422		Velocity signal from pulse pick up

## LINK ACCESS

Access to the internal circuit boards, so the links can be set, is achieved by the following:

- Remove both electrical connectors.
- Using a medium sized, flat blade screw driver, push in one side tab while pulling the cover away from the base. The cover will click over the tab.
- Repeat for the other tab on that side.
- After the two tabs on one side are released, the other side will release by simply angling the cover.
- Withdraw the electronics assembly and identify the circuit boards by their part numbers C70349 and C70365.

# G122-828

## INTERCONNECT DIAGRAM

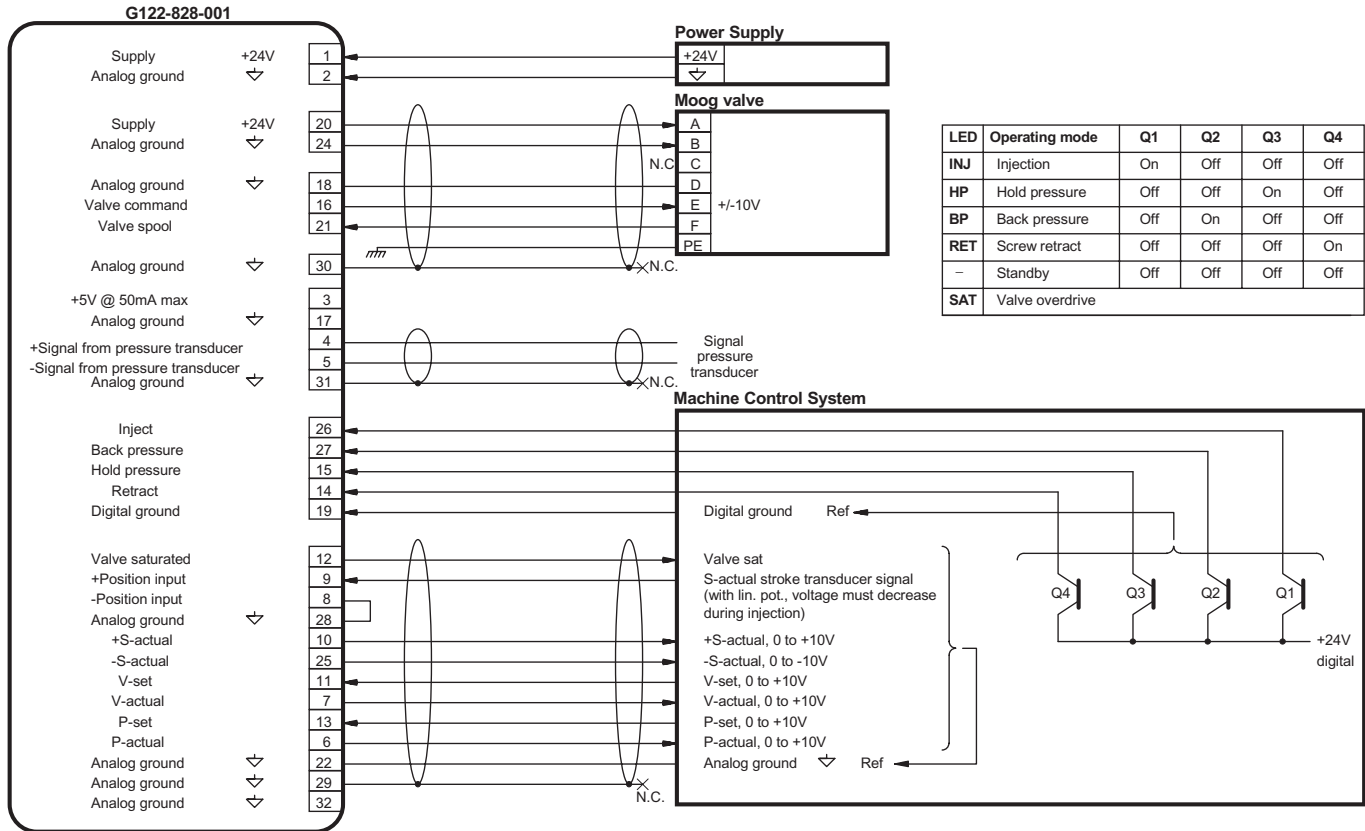

## ORDERING INFORMATION

G122-828-001 VP Controller

## INTERNET DATA

For the latest version of this Data Sheet please refer to the Moog website [www.moog.com/dinmodules](http://www.moog.com/dinmodules)

# MOOG

Moog Australia Pty. Ltd. 14 Miles Street, Mulgrave, Victoria 3170, Australia. Telephone: 03 9561 6044. Fax: 03 9562 0246.  
 Industrial Controls Division. Moog Inc., East Aurora, NY 14052-0018. Telephone: 716/652-3000. Fax: 716/655-1803. Toll Free 1-800-272-MOOG.  
 Moog GmbH. Hanns-Klemm-Strasse 28, 71034 Böblingen, Germany. Telephone: 07031-622-0. Fax: 07031-622-100.  
 Moog Japan Ltd. 1-8-37 Nishisindo, Hiratsuka, Kanagawa, Japan 254-0019. Telephone: 81 463 55 3615. Fax: 81 463 54 4709.

For the location nearest you, contact: [www.moog.com/worldwide](http://www.moog.com/worldwide).

Moog pursues a policy of continuous development and reserves the right to alter designs and specifications without prior notice. Information contained herein is for guidance only and does not form part of a contract.

Australia: Melbourne, Sydney, Brisbane ■ Austria: Vienna ■ Brazil: São Paulo ■ Denmark: Birkerød ■ England: Tewkesbury ■ Finland: Espoo ■ France: Rungis ■ Germany: Böblingen, Dusseldorf ■ Hong Kong: Shatin  
 India: Bangalore ■ Ireland: Ringaskiddy ■ Italy: Malnate (VA) ■ Japan: Hiratsuka ■ Korea: Kwangju-Kun ■ Philippines: Baguio City ■ Singapore: Singapore ■ Sweden: Askim ■ USA: East Aurora (NY)