

MOOG

G77XK Series Installation and Operation Instruction Electrohydraulic Servovalve Intrinsic Safety Protected



I. INTRODUCTION

This manual provides instructions and procedures necessary to install, operate and troubleshoot the Moog Inc. Series G771K/G772K/G773K (simplified as G77XK) intrinsic safety protected industrial servovalve. It is also applicable to Moog Series 77X servovalves.

The G77XK series valves are electrical equipment for hazardous areas requiring intrinsic safety or non-incendive protection. The approved hazardous location markings include:

⊕ II 1 G Ex ia IIB/IIC T4 Ga KEMA 02ATEX 1015 X

⊕ II 3 G Ex ec IIC T4 Gc KEMA 02ATEX 1016 X

CE 0344 per ATEX directive 2014/34/EU

Ex ia IIB/IIC T4 Ga IECEx KEM 10.0041X

Ex ec IIC T4 Gc IECEx KEM 10.0041X

per IECEx certification scheme.

The G77XK servovalves are also approved by FM, CSA, and TIIS for hazardous locations. They are intended for directional, position, velocity, pressure and force control in hydraulic control systems. Their standard fluorocarbon seals provide compatibility with a wide variety of hydraulic fluids.



2. OPERATION

The Moog G77XK series industrial servovalve consists of a polarized electrical torque motor and two stages of hydraulic power amplification. The motor armature extends into the air gaps of the magnetic flux circuit and is supported in this position by a flexure tube member. The flexure tube acts as a seal between the electromagnetic and hydraulic sections of the valve. The two motor coils surround the armature, one on each side of the flexure tube.

The flapper of the first stage hydraulic amplifier is rigidly attached to the midpoint of the armature. The flapper extends through the flexure tube and passes between two nozzles, creating two variable orifices between the nozzle tips and the flapper. The pressure controlled by the flapper and nozzle variable orifice is fed to the end areas of the second stage spool.

The second stage is a conventional four-way spool design in which output flow from the valve, at a fixed valve pressure drop, is proportional to spool displacement from the null position. A cantilever feedback spring is fixed to the flapper and engages a slot at the center of the spool. Displacement of the spool deflects the feedback spring which creates a force on the armature/flapper assembly.

ELECTROHYDRAULIC VALVE CUT-AWAY

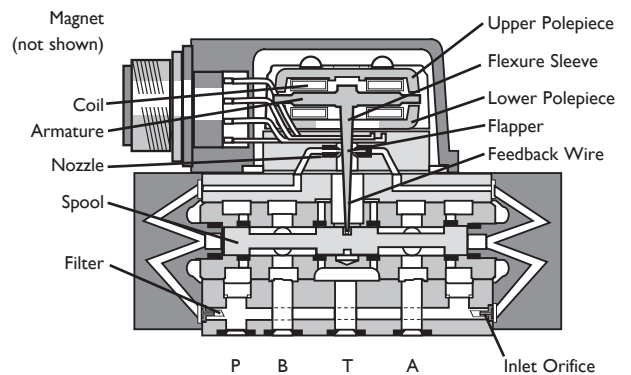

Figure 1 Moog Series G77XK

CAUTION

DISASSEMBLY, MAINTENANCE, OR REPAIR OTHER THAN IN ACCORDANCE WITH THE INSTRUCTIONS HEREIN OR OTHER SPECIFIC WRITTEN DIRECTIONS FROM MOOG WILL INVALIDATE MOOG'S OBLIGATIONS UNDER ITS WARRANTY AND YIELD THE INTRINSICALLY SAFE PROTECTION PERMIT NULL AND VOID.

Input signal induces a magnetic charge in the armature and causes a deflection of the armature and flapper. This assembly pivots about the flexure tube and increases the size of one nozzle orifice and decreases the size of the other.

This action creates a differential pressure from one end of the spool to the other and results in spool displacement. The spool displacement transmits a force to the feedback wire which opposes the original input signal torque. Spool movement continues until the feedback wire force equals the input signal force.

3. ELECTRICAL INFORMATION AND INTRINSICALLY SAFE CIRCUIT SAFETY PARAMETERS

- a. A wide choice of coils is available for a variety of rated current requirements. The torque motor coil leads are attached to the connector so external connections can provide series, parallel or single coil operation. The valves are equipped either with an MS type connector or with pigtail leads for electrical wiring. Refer to installation drawings of the specific model for details. Servovalve coils should be driven with current to provide consistency throughout the temperature range.
- b. The G77XK valves are approved for intrinsically safe protection per EN IEC 60079-0 : 2018, EN 60079-7 : 2015, and EN 60079-11 : 2012 for ATEX, and IEC 60079-0 : 2017, IEC 60079-7 : 2017, and IEC 60079-11 : 2011 for IECEx. The approved safety parameters are listed in the following table for all the coils used by G77XK series. Coil number is marked on the valve nameplate.

Coil Configuration	EX Marking	U _i (MAX)	I _i (MAX)
G4220-031 (single, series, parallel)	Ex ia IIB T4	12 V	120 mA
G4220-051/098 (single, series, parallel)	Ex ia IIB T4	12 V	240 mA
G4221-001 G4220-042 (single)	Ex ia IIC T4	16 V	160 mA
G4221-001 G4220-042 (single)	Ex ia IIC T4	24.4 V	85 mA
G4220-031 (single, parallel)	Ex ia IIC T4	30 V	26 mA
G4220-031 (series)	Ex ia IIC T4	30 V	18 mA
G4220-051/098 (single, parallel)	Ex ia IIC T4	30 V	19 mA
G4220-051/098 (series)	Ex ia IIC T4	30 V	12.7 mA
G4220-042 (single)	Ex ia IIC T4	30 V	37 mA
G4220-042 (parallel)	Ex ia IIC T4	30 V	20 mA
G4220-042 (series)	Ex ia IIC T4	30 V	10 mA
G4221-001 (single)	Ex ia IIC T4	30 V	28 mA

- c. The G77XK valves are approved for non-incendive operation for supply current not to exceed 50 mA dc.
- d. When making electric connections to the valve, appropriate measures must be taken to ensure that locally different earth potential do not result in excessive ground currents. When barriers are required for the hazardous location, hazardous area (field) wiring must meet the requirements of the barrier manufacturer. All barriers must be mounted and installed in compliance with the barrier manufacturer's requirements. Twisted pairs of 18-20 gage wire are recommended. If shielded wire is used, connect shield wire to earth ground only at the barrier strip.

4. SPECIAL CONDITIONS FOR SAFE USE

Because the enclosure of the apparatus is made of aluminum, if it is mounted in an area where the use of category I G apparatus is required, it must be installed such that even in the event of rare incidents, ignition sources due to impact and friction sparks are excluded.

When the electrohydraulic servovalve is used in an application for type of explosion protection intrinsic safety "i", the appropriate box on the data label must be scored. When the electrohydraulic servovalve is used in an application for type of explosion protection "n", the appropriate box on the data label must be scored.

After use in an application for type of explosion protection "n", the servovalve cannot be safely used in a intrinsically safe application.

The screwed cable connector may only be disconnected when the circuit is de-energized or when the location is known to be non-hazardous.

When used at an ambient temperature $\geq 70^{\circ}\text{C}$, heat resistant cable must be used with a continuous operating temperature in accordance with the application.

When the electrohydraulic servovalve is used in type of protection "n" or "ec", the equipment shall only be used in an area of not more than Pollution Degree 2, as defined in IEC 60664-1.

The cable gland shall be installed such that impact is not possible.

When the electrohydraulic servovalve is used in type of protection "n" or "ec", the user shall provide additional clamping of the cable to ensure that pulling is not transmitted to the terminations.

5. HYDRAULIC SYSTEM PREPARATION

To prolong servovalve operational life and to reduce hydraulic system maintenance, it is recommended that the hydraulic fluid be kept at a cleanliness level of ISO DIS 4406 Code 16/13 maximum, 14/11 recommended. The most effective filtration scheme incorporates the use of a kidney loop or "off-line" filtration as one of the major filtration components. The filter for the "off-line" filtration scheme should be a $\beta_3 \geq 75$ filter for maximum effectiveness.

Upon system startup and prior to mounting the servovalve, the entire hydraulic system should be purged of built-in contaminating particles by an adequate flushing. The servovalve should be replaced by a flushing manifold and the hydraulic circuit powered up under conditions of fluid temperature and fluid velocity, reasonably simulating normal operating conditions. New system filters are installed during the flushing process whenever the pressure drop across the filter element becomes excessive. The flushing processes should turn over the fluid in the reservoir between fifty to one hundred times.

To maintain a clean hydraulic system, the filters must be replaced on a periodic basis. It is best to monitor the pressure drop across the filter assembly and replace the filter element when the pressure drop becomes excessive. In addition to other filters that are installed in the hydraulic circuit, it is recommended that a large capacity, low pressure $\beta_3 \geq 75$ filter be installed in the return line. This filter will increase the interval between filter element replacements and greatly reduce the system contamination level.

6. INSTALLATION

The Moog G77XK Series Industrial Servovalve may be mounted in any position, provided the servovalve pressure, piston and return ports match respective manifold ports.

The mounting pattern, port location and mounting bolts of the servovalve are shown on Figure 4. Apply a light film of oil to the screw threads and torque to 57 inch-pounds.

Wire mating connector for desired coil configuration and polarity. Thread connector to valve.

7. MECHANICAL NULL ADJUSTMENT

It is often desirable to adjust the flow null of a servovalve independent of other system parameters. The "mechanical null adjustment" on the Moog G77XK Series servovalve allows at least $\pm 20\%$ adjustment of flow null. The "mechanical null adjustor" is an eccentric bushing retainer pin located above the port designation on the valve body (see Figure 2) which, when rotated, provides control of the bushing position. Mechanical feedback elements position the spool relative to the valve body for a given input signal. Therefore, a movement of the bushing relative to the body changes the flow null.

Figure 2
Mechanical Null Adjustment

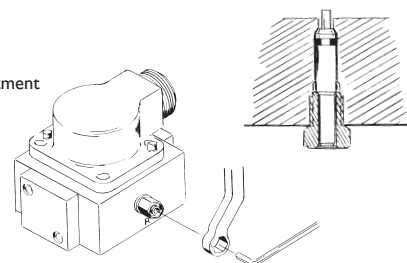

Adjustment Procedure

Using a $3/8$ inch offset box wrench, loosen the self-locking fitting until the null adjustor pin can be rotated. (This should usually be less than $1/2$ turn). DO NOT remove self-locking fitting.

Insert a $3/32$ inch allen wrench in null adjustor pin. Use the $3/32$ inch Allen wrench to rotate the mechanical null adjustor pin to obtain desired flow null. Torque self-locking fitting to 57 inch lbs.

Note: Clockwise rotation of null adjustor pin produces flow from port P to port B.

8. GENERAL SERVICING RECOMMENDATIONS

- Disconnect electrical lead to servovalve.
- Relieve hydraulic system of residual pressure.
- Remove servovalve.

9. TROUBLESHOOTING CHART

The following troubleshooting chart list potential troubles encountered, probable causes, and remedies.

Potential Trouble	Probable Cause	Remedy
Servovalve does not follow input command signal. (Actuator or components are stationary or creeping slowly.)	Plugged inlet filter element.	Replace filter element.
High threshold. (Jerky, possible oscillatory or "hunting" motion in closed loop system.)	Plugged filter element.	Replace filter element.
Poor response. (Servovalve output lags electrical command signal.)	Partially plugged filter element.	Replace filter element and check for dirty hydraulic fluid in system.
High Null Bias. (High input current required to maintain hydraulic cylinder or motor stationary.)	1. Incorrect null adjustment 2. Partially plugged filter element.	1. Readjust null 2. Replace filter element and check for dirty hydraulic fluid in system.

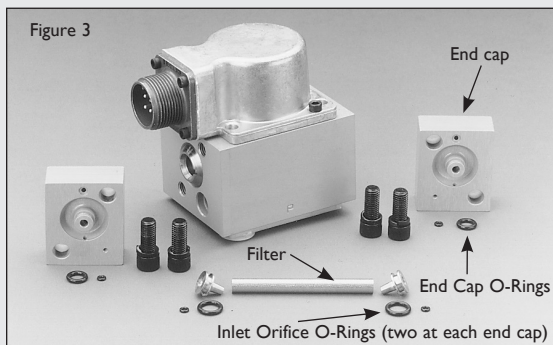

Figure 3

Table I. Replacement Parts

Part Description	Qty.	Part Number
G77XK Series Filter Replacement Kit	1	B52555RK054K001
Inlet Orifice O-Rings (1)	2	-42082-001
Inlet Orifice O-Rings (1)	2	-42082-189
End Cap O-Rings (1)	2	-42082-042
Filter Tube (1)	1	C39486-005-060
End Cap O-Rings (1)	2	-42082-001
Base O-Rings		
G771K	4	-42082-007
G772K	4	-42082-013
G773K	4	-42082-022

(1) Included in Filter Replacement Kit.

10. FILTER ASSEMBLY REPLACEMENT

Tools and Equipment

- Blade screwdriver
 - $\frac{3}{16}$ Allen wrench
 - Torque wrench
 - Tweezers
- Remove four socket head cap screws and lockwashers using a $\frac{3}{16}$ inch Allen wrench. Remove end caps.
 - Remove o-rings from end caps.
 - Remove inlet orifice assembly from both sides of body.
Note: 2-56 screw threads into the inlet orifice assembly.
Remove filter. The inlet orifice assemblies are matched to each other and are therefore interchangeable.
Note: These assemblies seat in body and cannot go through bore during removal.
 - Remove o-rings from inlet orifice assemblies.
 - Visually inspect orifice assemblies for damage or foreign material.
 - Discard o-rings and filter.
 - Install o-rings on inlet orifices.
 - Install filter and inlet orifice assembly in body. Inlet orifice assembly pilots into filter. Install the other inlet orifice assembly into other end of filter.
 - Install o-rings on end caps.
 - Install end caps on body and install four socket head cap screws and lockwashers. Torque the screws to 85 inch-pounds.

11. FUNCTIONAL CHECKOUT AND CENTERING

- Install servovalve on hydraulic system or test fixture, but do not connect electrical lead.
- Apply required system pressure to servovalve and visually examine for evidence of external leakage. If leakage is present and cannot be rectified by replacing o-rings, remove the discrepant component and return for repair or replacement.
Note: If the system components are drifting or hardover, adjust the mechanical null of the servovalve.
- Connect electrical lead to servovalve and check phasing in accordance with system requirements.

12. AUTHORIZED REPAIR FACILITIES

If servovalve continues to malfunction after all recommended corrective action procedures are performed, defective valve should be returned to Moog for repair. Moog does not authorize any facilities other than Moog or Moog subsidiaries to repair its servovalves. It is recommended you contact Moog at (716) 652-2000 to locate your closest Moog repair facility. Repair by an independent (unauthorized) repair house will result in voiding the Moog warranty and could lead to performance degradation or safety problems.

13. DECLARATION OF MANUFACTURER

An EU Declaration of Conformity according to Council Directive 2014/34/EU is supplied with each servovalve.

G77XK SERIES INSTALLATION AND OPERATION INSTRUCTION

NOTES

1 Fluid:

Industrial type petroleum base hydraulic fluid, maintained to ISO DIS 4406 Code 14/11 recommended.

2 Operating Temperature Range:

-20°F [-29°C] to +275°F [+135°C] unless otherwise specified on nameplate.

3 Valve Phasing:

Flow out port B results when Series coils: B & C connected, A+, D-; Parallel coils: A & C connected, B & D connected; Single coil: A+, B-, or C+, D-.

4 Ports:

See table below left.

5 Surface:

Surface to which valve is mounted requires \sqrt{V} finish, flat within 0.002 [0.05] TIR.

6 Null Adjust:

Flow out port B results with clockwise rotation of null adjust screw ($\frac{1}{32}$ hex key). Flow bias is continually varied for a given port as the null adjust is rotated.

TYPICAL WIRING SCHEMATIC

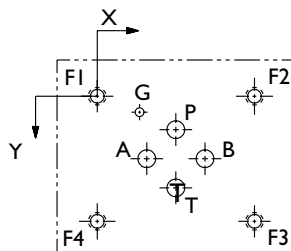
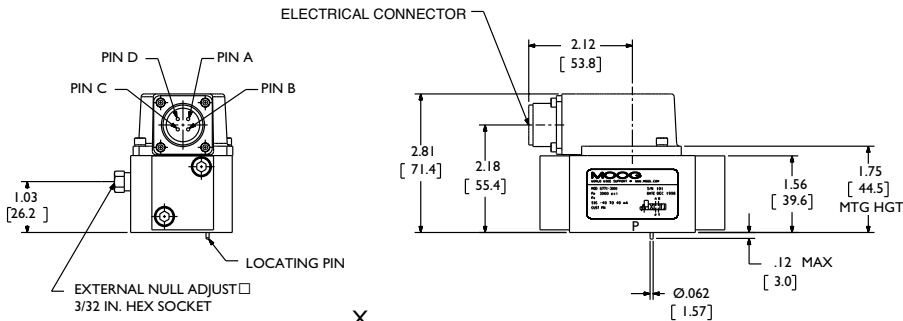
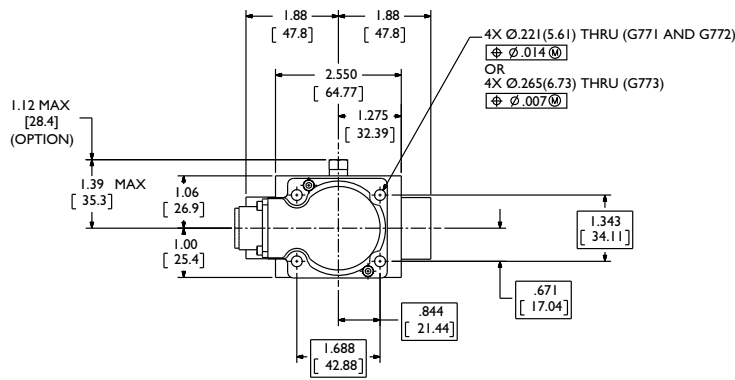
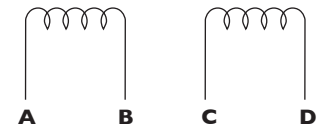

G771K U.S.

	P	A	B	T	G	F1	F2	F3	F4
	Ø .191	Ø .191	Ø .191	Ø .191	Ø .094	.190-32	.190-32	.190-32	.190-32
X	0.84	0.53	1.16	0.84	0.45	0	1.69	1.69	0
Y	0.36	0.67	0.67	0.98	0.17	0	0	1.34	1.34

METRIC

	P	A	B	T	G	F1	F2	F3	F4
	4.85	4.85	4.85	4.85	2.39	M5	M5	M5	M5
X	21.3	13.5	29.5	21.3	11.4	0	42.9	42.9	0
Y	9.1	17.0	17.0	24.9	4.3	0	0	34.0	34.0

G772K U.S.

	P	A	B	T	G	F1	F2	F3	F4
	Ø .260	Ø .260	Ø .260	Ø .260	Ø .094	.190-32	.190-32	.190-32	.190-32
X	0.84	0.45	1.23	0.84	0.45	0	1.69	1.69	0
Y	0.28	0.67	0.67	1.06	0.17	0	0	1.34	1.34

METRIC

	P	A	B	T	G	F1	F2	F3	F4
	6.6	6.6	6.6	6.6	2.39	M5	M5	M5	M5
X	21.3	11.4	31.2	21.3	11.4	0	42.9	42.9	0
Y	7.2	17.0	17.0	27.0	4.3	0	0	34.0	34.0

G773K U.S.

	P	A	B	T	G	F1	F2	F3	F4
	Ø .312	Ø .312	Ø .312	Ø .312	Ø .094	.250-20	.250-20	.250-20	.250-20
X	0.84	0.38	1.31	0.84	0.45	0	1.69	1.69	0
Y	0.20	0.67	0.67	1.14	0.17	0	0	1.34	1.34

METRIC

	P	A	B	T	G	F1	F2	F3	F4
	7.92	7.92	7.92	7.92	2.39	M6	M6	M6	M6
X	21.3	9.7	33.3	21.3	11.4	0	42.9	42.9	0
Y	5.1	17.0	17.0	29.0	4.3	0	0	34.0	34.0

Figure 4

Three standard designs are available.

Model Number	Port Circle Diameter		Port Diameter		Manifold O-Rings		Mounting Bolt Size
	in	mm	in	mm	Moog	MS	(socket head cap screws)
G771K	.625	15.8	.191	4.85	-007	-010	.190-32 NF
G772K	.780	19.8	.260	6.60	-013	-012	.190-32 NF
G773K	.937	23.8	.312	7.93	-022	-013	.250-28 NF

The products described herein are subject to change at any time without notice, including, but not limited to, product features, specifications, and designs.

MOOG

Industrial Controls Division
 Moog Inc., East Aurora, NY 14052-0018
 Telephone: 716/652-2000
 Fax: 716/687-7910
 Toll Free: 1-800-272-MOOG
 www.moog.com/industrial