

# PROPORTIONAL VALVES

DIRECT OPERATED  
WITH INTEGRATED  
ELECTRONICS

D926 AND D927 SERIES  
ISO 4401 SIZE 03 AND 05



Rev. C, January 2024

PROPORTIONAL VALVES OFFERING  
HIGH ROBUSTNESS AND RELIABILITY

**MOOG** | Shaping the way our world moves™

Whenever the highest levels of motion control performance and design flexibility are required, you'll find Moog expertise at work. Through collaboration, creativity and world-class technological solutions, we help you overcome your toughest engineering obstacles. Enhance your machine's performance. And help take your thinking further than you ever thought possible.

INTRODUCTION.....	2
Product Overview .....	3
Features and Benefits.....	4
Description of Operation .....	5
TECHNICAL DATA .....	6
D926.....	6
D927.....	11
BACKGROUND .....	16
Electronics .....	16
Flow Calculation.....	19
ORDERING INFORMATION.....	20
Accessories and Spare Parts.....	20
Notes.....	22
Ordering Code.....	23

---

This catalog is for users with technical knowledge. To ensure all necessary characteristics for function and safety of the system, the user has to check the suitability of the products described herein. The products described in this document are subject to change without notice. In case of doubt, please contact Moog.

Moog is a registered trademark of Moog Inc. and its subsidiaries. All trademarks as indicated herein are the property of Moog Inc. and its subsidiaries. For the full disclaimer refer to [www.moog.com/literature/disclaimers](http://www.moog.com/literature/disclaimers).

For the most current information, visit [www.moog.com/industrial](http://www.moog.com/industrial) or contact your local Moog office.

## PRODUCT OVERVIEW

Moog D926 and D927 Series Valves are direct operated proportional valves driven by two proportional solenoids. They are equipped with integrated electronics and closed-loop position control of the spool.

The valves are suitable for electrohydraulic control of position, speed, pressure and force in open-loop and closed-loop control systems.

The robust design allows for a high resistance against harsh environmental conditions like high vibrations and temperature.

These valves offer analog interfaces for command signal and spool position feedback. They are however, equipped with modern electronics with a digital core that offers high energy efficiency while delivering high static and dynamic control performance.

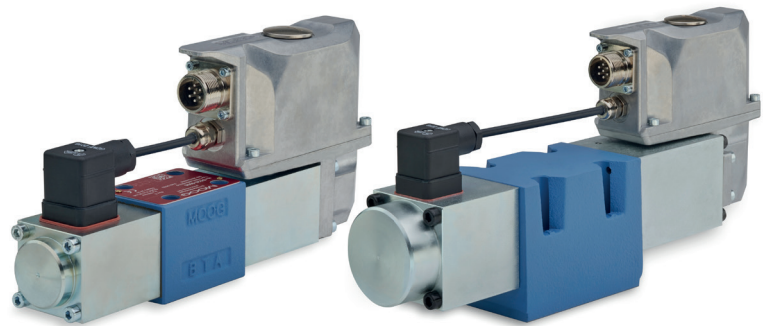

	D926	D927
<b>Valve design</b>	1-stage, with spool-in-body	
<b>Size according ISO 4401</b>	03	05
<b>Mounting pattern</b>	ISO 4401-03-03-0-05 (with or without leakage oil port Y)	ISO 4401-05-05-0-05 (without leakage port Y)
<b>Rated flow at <math>\Delta p_N</math> 5 bar (75 psi)/spool land</b>	4 to 32 l/min (1.06 to 8.5 gpm)	25 to 75 l/min (6.6 to 19.8 gpm)
<b>Maximum flow</b>	80 l/min (21.1 gpm)	180 l/min (47.6 gpm)
<b>Maximum operating pressure - port P, A, B</b>	350 bar (5,000 psi)	
<b>Step response time for 0 to 100 % stroke</b>	18 ms	< 28 ms (for spool with < 3 % overlap)

## FEATURES AND BENEFITS

<b>Features</b>	<b>Benefits</b>
Proportional valve design with two proportional solenoids and spool-in-body	Large spool diameter and long spool stroke for high rated flows
Large variety of spool overlaps, flow characteristics, and signal options	Easily configurable to fit different applications
Electronics mechanically uncoupled from housing	High vibration resistance for longer service life and less machine downtime
Next-generation electronics with digital core and energy efficient components	Low thermal stress and long electronics life cycle
Electronics placed on the solenoid	Compact design for minimum installation space
Latest world-class valve design	Provides high accuracy and wear resistance

## DESCRIPTION OF OPERATION

### Valve Design

Moog D926 and D927 Series Proportional Control Valves are closed-loop hydraulic products that are used in industrial applications. These valves are electrical feedback valves, which means that the position control loop for the spool is closed by a position transducer and the integrated valve electronics.

The spool (8) is deflected by two proportional solenoids (5 and 11), one for each direction of movement. When the electrical power is cut off, the spool is centered between two springs (6 and 9). Spools are available with different overlaps, so the valve configuration can be adapted for specific applications.

The onboard electronics (3) is mounted on top of one of the solenoids to create a compact and space-saving valve shape. The electronics is uncoupled from the electronics housing and therefore provides a high resistance against vibrations and shocks.

### Operation

An electric command signal (spool position set point) is applied to the valve electronics via the main connector (1). A position transducer (4) measures the actual position of the spool (8). The electronics compare the spool position and the command signal, and control the Pulse Width Modulated (PWM) currents to the proportional solenoids. If a control deviation occurs, the PWM currents are changed to move the spool to the desired position. Afterwards, the PWM currents are kept at a level that holds the spool in this position.

Thus, the position of the spool is proportional to the electric command signal.

### D926 Cut-away

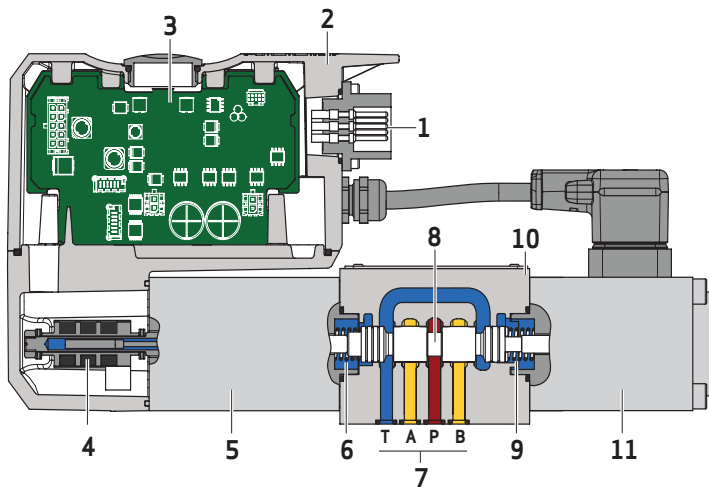

1. Valve connector
2. Electronics housing
3. Valve electronics
4. Position transducer (LVDT)
5. Proportional solenoid
6. Spring side A
7. Ports
8. Spool
9. Spring side B
10. Valve housing
11. Proportional solenoid

## D926

## General Technical Data

<b>Valve design</b>	1-stage, with spool-in-body
<b>Mounting pattern</b>	ISO 4401-03-03-0-05 (with or without leakage oil port Y)
<b>Installation position</b>	Any
<b>Weight</b>	3.5 kg (7.7 lb)
<b>Storage temperature range</b>	-40 to +80 °C (-40 to +176 °F)
<b>Ambient temperature range</b>	-20 to +60 °C (-4 to +140 °F)
<b>Vibration resistance</b>	30 g, 3 axis, 10 Hz to 2 kHz
<b>Shock resistance</b>	50 g, 6 directions, 3 ms
<b>MTTF<sub>a</sub> value according to EN ISO 13849-1</b>	150 years

## Hydraulic Data

<b>Maximum operating pressure</b>	
Port P, A, B	350 bar (5,000 psi)
Port T without Y	280 bar (4,000 psi) <sup>1)</sup>
Port T with Y	350 bar (5,000 psi)
Port Y	Depressurized to tank <sup>1)</sup>
<b>Rated flow at <math>\Delta p_N</math> 5 bar (75 psi)/spool land</b>	4/8/16/32 l/min (1.06/2.1/4.2/8.5 gpm)
<b>Maximum flow</b>	80 l/min (21.1 gpm)
<b>Typical leakage flow (32 l/min spool with 1.5 to 3 % overlap)<sup>2)</sup></b>	≤ 0.6 l/min (0.16 gpm)
<b>Hydraulic fluid</b>	Hydraulic oil as per DIN 51524 parts 1 to 3 and ISO 11158. Other fluids upon request.
<b>Temperature range</b>	-20 to +80 °C (-4 to +176 °F)
<b>Viscosity range</b>	
Recommended viscosity range at 38 °C (100 °F)	15 to 100 mm <sup>2</sup> /s (cSt)
Maximum permissible viscosity range at 38 °C (100 °F)	5 to 400 mm <sup>2</sup> /s (cSt)
<b>Recommended cleanliness class as per ISO 4406</b>	
For functional safety	20/18/15
For longer service life	17/14/11

1) In order to avoid an emptying of the return line, a back pressure of 2 bar (30 psi) should be maintained on the T and Y ports.

2) Measured at 140 bar (2,000 psi) system pressure, oil viscosity 32 mm<sup>2</sup>/s and oil temperature 40 °C (104 °F)

# D926

## Typical Static and Dynamic Data <sup>1)</sup>

<b>Step response time for 0 to 100 % stroke</b>	18 ms
<b>Threshold</b>	< 0.2 %
<b>Hysteresis</b>	< 0.2 %
<b>Null shift at <math>\Delta T = 55 \text{ K (131 } ^\circ\text{F)}</math></b>	< 1.5 %
<b>Sample deviation of rated flow</b>	< 3 %

## Electrical Data

<b>Duty cycle</b>	100 %
<b>Degree of protection according to IEC/EN 60529</b>	IP65 (with mounted mating connector)
<b>Supply voltage <sup>2)</sup></b>	24 V <sub>DC</sub> (18 to 32 V <sub>DC</sub> )
<b>Permissible ripple of supply voltage</b>	2.5 V <sub>PP</sub>
<b>Maximum current consumption <sup>3)</sup></b>	1.4 A
<b>Maximum power consumption</b>	33.6 W (1.4 A at 24 V <sub>DC</sub> )
<b>Fuse protection, external, per valve</b>	2 A (slow)
<b>EM compatibility</b>	<ul style="list-style-type: none"> <li>• Emitted interference as per DIN EN 61000-6-4</li> <li>• Immunity to interference as per EN 61000-6-2 (evaluation criterion A)</li> </ul>

1) Measured at 140 bar (2,000 psi) system pressure, oil viscosity 32 mm<sup>2</sup>/s and oil temperature 40 °C (104 °F)

2) All connected circuits must be isolated from the mains supply by „electrical separation“ in accordance with IEC/EN 61558-1 and IEC/EN 61558-2-6. Voltages must be limited to the safety extra-low voltage range in accordance with EN 60204-1. We recommend the use of SELV/PELV power packs.

3) Measured at +25 °C (+77 °F) ambient temperature and 24 V supply voltage

# D926

## Hydraulic Symbols

**4/3-way Operation with Spool Design L, 1, 3, and 4**

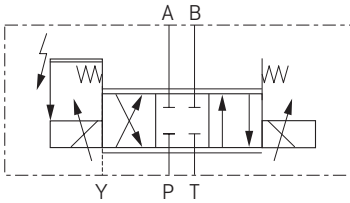

**4/2-way Operation with Spool Design 6**

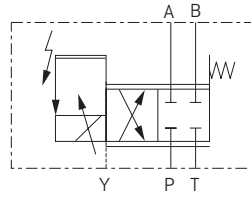

**4/3-way Operation with Spool Design 2 and 5**

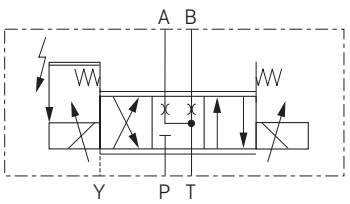

**4/2-way Operation with Spool Design 7**

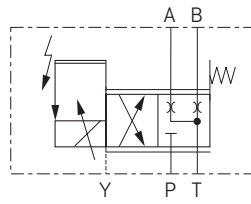



# D926

## Typical Characteristic Curves

**Step Response <sup>1)</sup>**

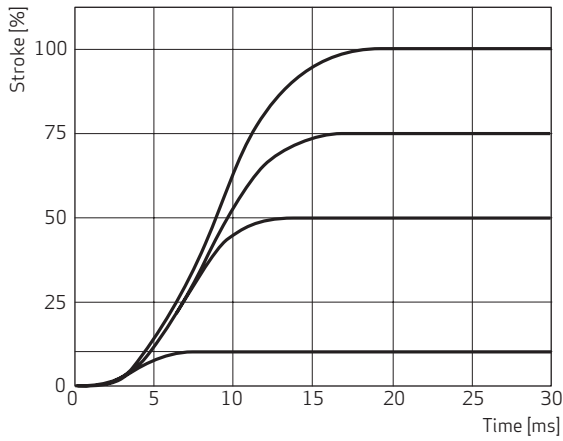

**Frequency Response <sup>1)</sup>**

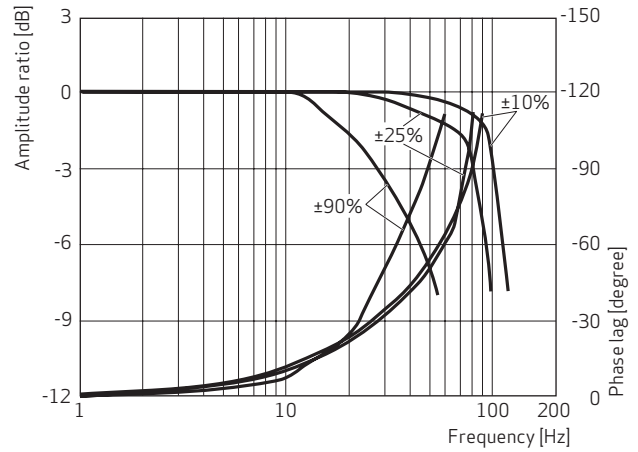

**Flow Signal Characteristic for Spool Design L**

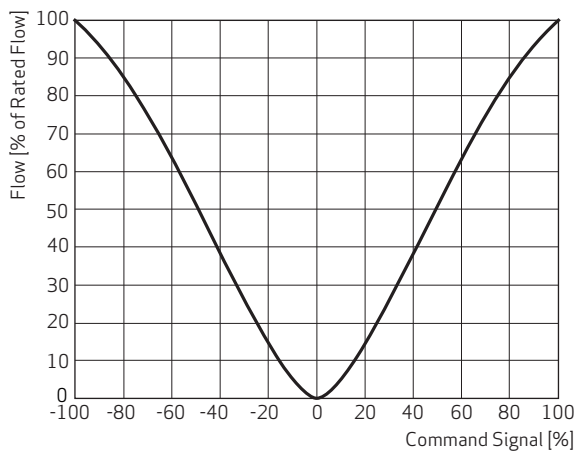

**Flow Signal Characteristic for Spool Design 1**

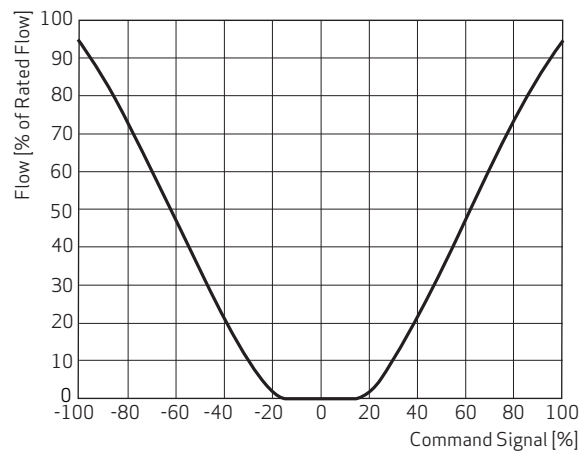

**Flow Signal Characteristic for Spool Design 2**

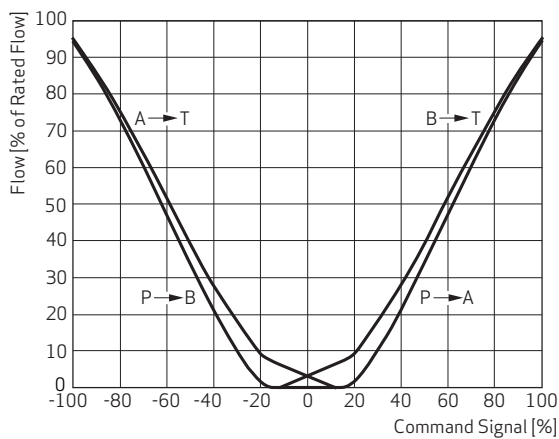

1) Measured at 140 bar (2,000 psi) system pressure, oil viscosity 32 mm<sup>2</sup>/s and oil temperature 40 °C (104 °F)

# D926

## Port Pattern of Mounting Surface

The mounting surface must conform to ISO 4401-03-03-0-05. Please observe a mounting length of a minimum 77 mm (3.0 in) and O-ring recesses for Y.

For maximum flow the ports for P, T, A and B must be designed with  $\varnothing 7.5$  mm (0.3 in), not according to the standard.

The evenness of the connecting surface has to be 0.01 mm (0.0004 in) over 100 mm (3.94 in), and average surface finish  $R_a$  better than  $0.8 \mu\text{m}$  (0.0000315 in).

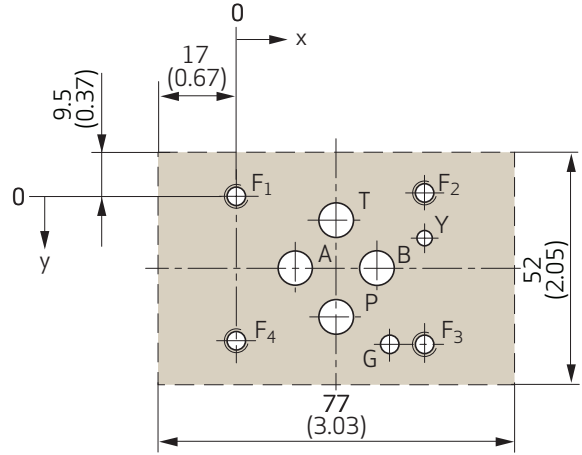

Designation		P	A	B	T	Y	F <sub>1</sub>	F <sub>2</sub>	F <sub>3</sub>	F <sub>4</sub>	G
Size $\varnothing$	mm	7.5				3.3	M5 <sup>1)</sup>				4
	in	0.30				0.13					0.16
Position X	mm	21.5	12.7	30.2	21.5	40.5	0	40.5		0	33
	in	0.85	0.50	1.19	0.85	1.59		1.59			1.30
Position Y	mm	25.9	15.5		5.1	9	0	-0.75	31.75	31	31.75
	in	1.02	0.61		0.20	0.35		-0.03	1.25	1.22	1.25

1) For screw dimensions and tightening torques please refer to section "Accessories and Spare Parts"

## Installation Drawing (4/3-way Version)

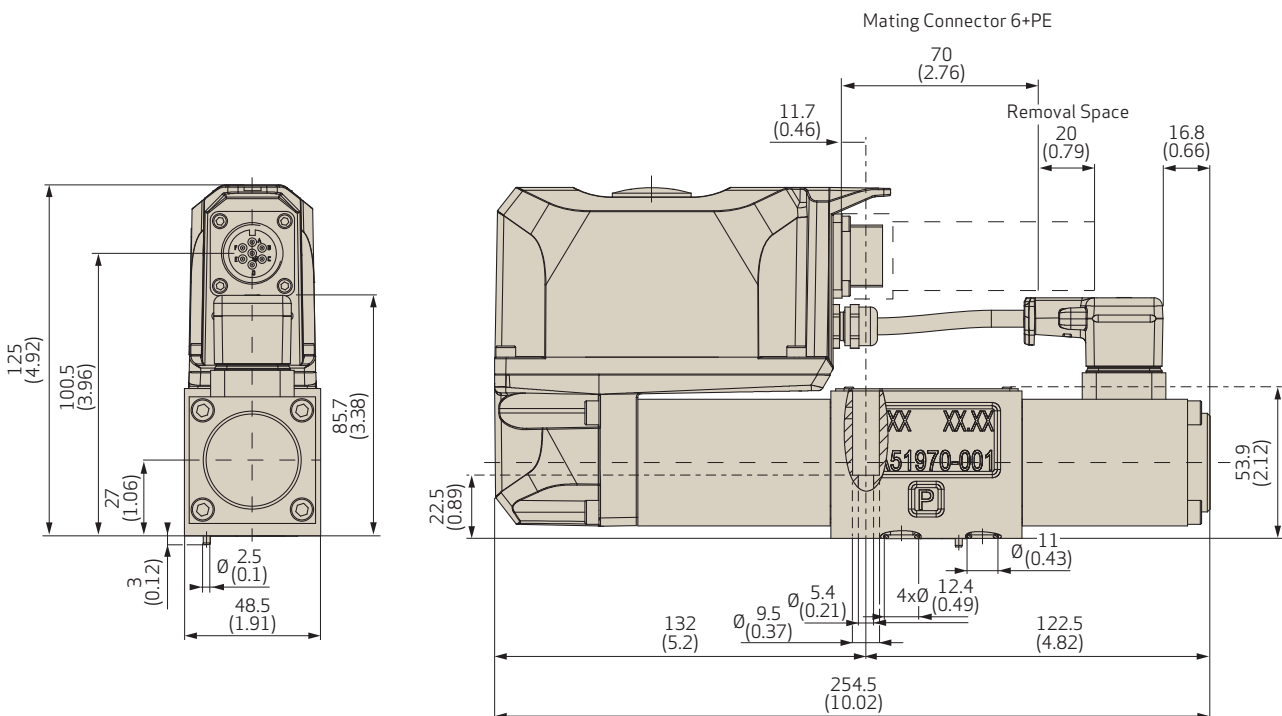

## D927

## General Technical Data

<b>Valve design</b>	1-stage, with spool-in-body
<b>Mounting pattern</b>	ISO 4401-05-05-0-05 (without leakage oil port Y)
<b>Installation position</b>	Any
<b>Weight</b>	
4/3-way	8 kg (17.6 lb)
4/2-way	6.6 kg (14.6 lb)
<b>Storage temperature range</b>	-40 to +80 °C (-40 to +176 °F)
<b>Ambient temperature range</b>	-20 to +60 °C (-4 to +140 °F)
<b>Vibration resistance</b>	20 g, 3 axis, 10 Hz to 2 kHz
<b>Shock resistance</b>	50 g, 6 directions, 3 ms
<b>MTTF<sub>d</sub> value according to EN ISO 13849-1</b>	150 years

## Hydraulic Data

<b>Maximum operating pressure</b>	
Port P, A, B	350 bar (5,000 psi)
Port T	250 bar (4,000 psi) <sup>1)</sup>
<b>Rated flow at <math>\Delta p_N</math> 5 bar (75 psi)/spool land</b>	25/50/75 l/min (6.6/13.2/19.8 gpm)
<b>Maximum flow</b>	180 l/min (47.6 gpm)
<b>Typical leakage flow (75 l/min spool with &lt; 3 % overlap)<sup>2)</sup></b>	≤ 1.2 l/min (0.32 gpm)
<b>Hydraulic fluid</b>	Hydraulic oil as per DIN 51524 parts 1 to 3 and ISO 11158. Other fluids upon request.
<b>Temperature range</b>	-20 to +80 °C (-4 to +176 °F)
<b>Viscosity range</b>	
Recommended viscosity range at 38 °C (100 °F)	15 to 100 mm <sup>2</sup> /s (cSt)
Maximum permissible viscosity range at 38 °C (100 °F)	5 to 400 mm <sup>2</sup> /s (cSt)
<b>Recommended cleanliness class as per ISO 4406</b>	
For functional safety	20/18/15
For longer service life	17/14/11

1) In order to avoid an emptying of the return line, a back pressure of 2 bar (30 psi) should be maintained on the T ports.

2) Measured at 140 bar (2,000 psi) system pressure, oil viscosity 32 mm<sup>2</sup>/s and oil temperature 40 °C (104 °F)

## D927

Typical Static and Dynamic Data <sup>1)</sup>

<b>Step response time for 0 to 100 % stroke</b>	< 28 ms (for spool with < 3 % overlap)
<b>Threshold</b>	< 0.2 %
<b>Hysteresis</b>	< 0.2 %
<b>Null shift at <math>\Delta T = 55 \text{ K (131 } ^\circ\text{F)}</math></b>	< 1.5 %
<b>Sample deviation of rated flow</b>	< 3 %

## Electrical Data

<b>Duty cycle</b>	100 %
<b>Degree of protection according to IEC/EN 60529</b>	IP65 (with mounted mating connector)
<b>Supply voltage <sup>2)</sup></b>	24 V <sub>DC</sub> (18 to 32 V <sub>DC</sub> )
<b>Permissible ripple of supply voltage</b>	2.5 V <sub>PP</sub>
<b>Maximum current consumption <sup>3)</sup></b>	3 A
<b>Maximum power consumption</b>	72 W (3 A at 24 V <sub>DC</sub> )
<b>Fuse protection, external, per valve</b>	3.15 A (slow)
<b>EM compatibility</b>	<ul style="list-style-type: none"> <li>Emitted interference as per DIN EN 61000-6-4</li> <li>Immunity to interference as per EN 61000-6-2 (evaluation criterion A)</li> </ul>

1) Measured at 140 bar (2,000 psi) system pressure, oil viscosity 32 mm<sup>2</sup>/s and oil temperature 40 °C (104 °F)

2) All connected circuits must be isolated from the mains supply by „electrical separation“ in accordance with IEC/EN 61558-1 and IEC/EN 61558-2-6. Voltages must be limited to the safety extra-low voltage range in accordance with EN 60204-1. We recommend the use of SELV/PELV power packs.

3) Measured at +25 °C (+77 °F) ambient temperature and 24 V supply voltage

# D927

## Hydraulic Symbols

**4/3-way Operation with Spool Design L, 1, 3, and 4**

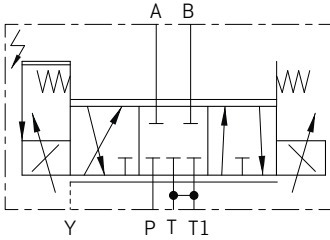

**4/2-way Operation with Spool Design 6**

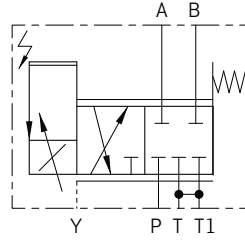

**4/3-way Operation with Spool Design 2 and 5**

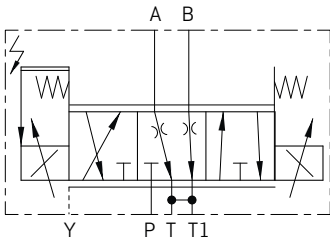

**4/2-way Operation with Spool Design 7**

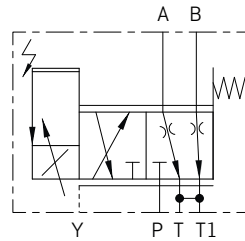

# D927

## Typical Characteristic Curves

**Step Response for Spool Design L<sup>1)</sup>**

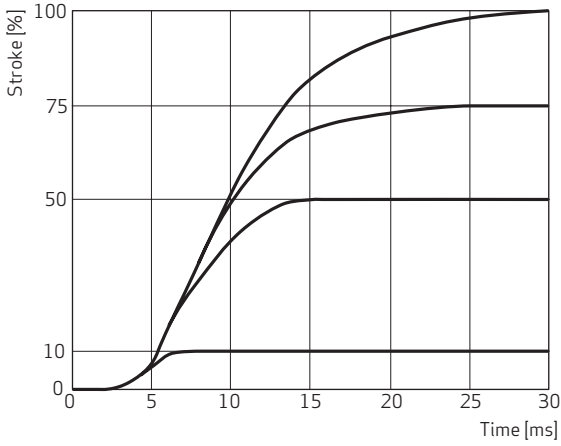

**Frequency Response for Spool Design L<sup>1)</sup>**

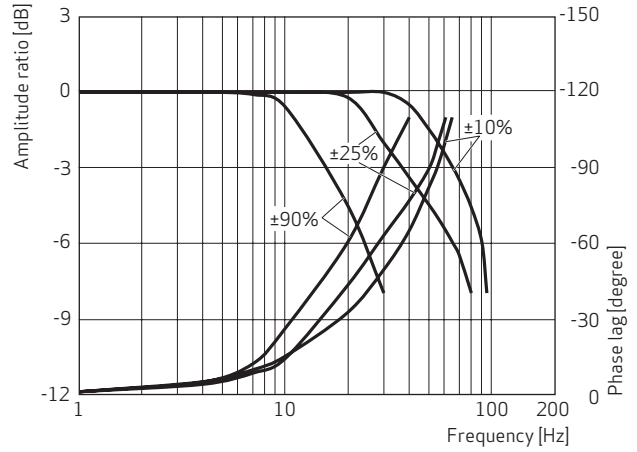

**Flow Signal Characteristic for Spool Design L**

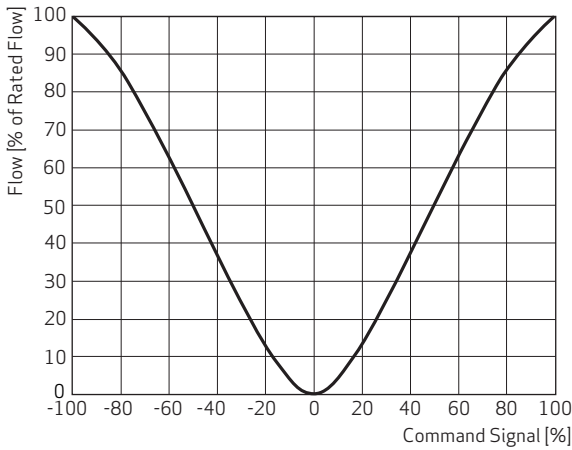

**Flow Signal Characteristic for Spool Design 1**

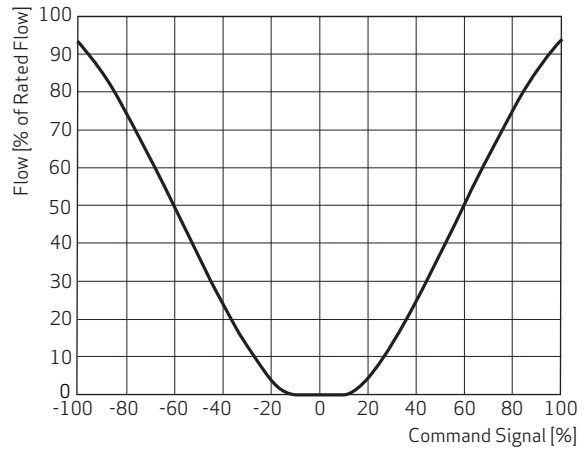

**Flow Signal Characteristic for Spool Design 2**

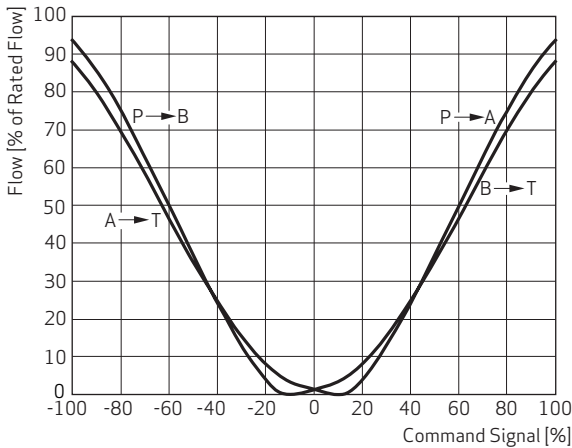

1) Measured at 140 bar (2,000 psi) system pressure, oil viscosity 32 mm<sup>2</sup>/s and oil temperature 40 °C (104 °F)

# D927

## Port Pattern of Mounting Surface

The mounting surface must conform to ISO 4401-05-05-0-05. Please observe a mounting length of a minimum 100 mm (3.94 in).

For  $Q > 60$  l/min (15.9 gpm) the second tank port T1 is required.

For maximum flow the ports for P, T, T1, A and B must be designed with  $\varnothing 11.5$  mm (0.45 in), not according to the standard.

The evenness of the connecting surface has to be 0.01 mm (0.0004 in) over 100 mm (3.94 in), and average surface finish  $R_a$  better than  $0.8 \mu\text{m}$  (0.0000315 in).

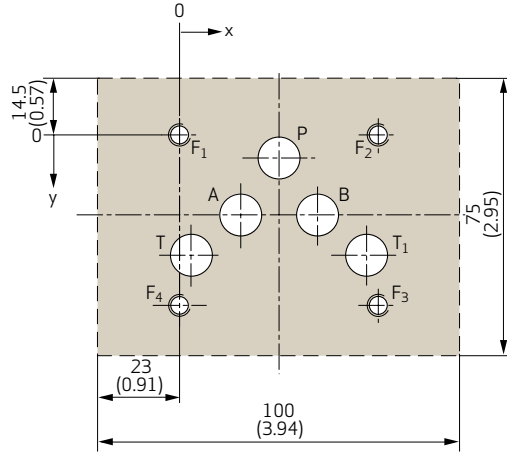

Designation		P	A	B	T	T <sub>1</sub>	F <sub>1</sub>	F <sub>2</sub>	F <sub>3</sub>	F <sub>4</sub>	
Size $\varnothing$	mm	11.2					M6				
	in	0.44									
Position X	mm	27	16.7	37.3	3.2	50.8	0	54		0	
	in	1.06	0.66	1.47	0.13	2		2.13			
Position Y	mm	6.3	21.4		23.5		0		46	46	
	in	0.25	0.84		1.28				1.81	1.81	

1) For screw dimensions and tightening torques please refer to section "Accessories and Spare Parts"

## Installation Drawing (4/3-way Version)

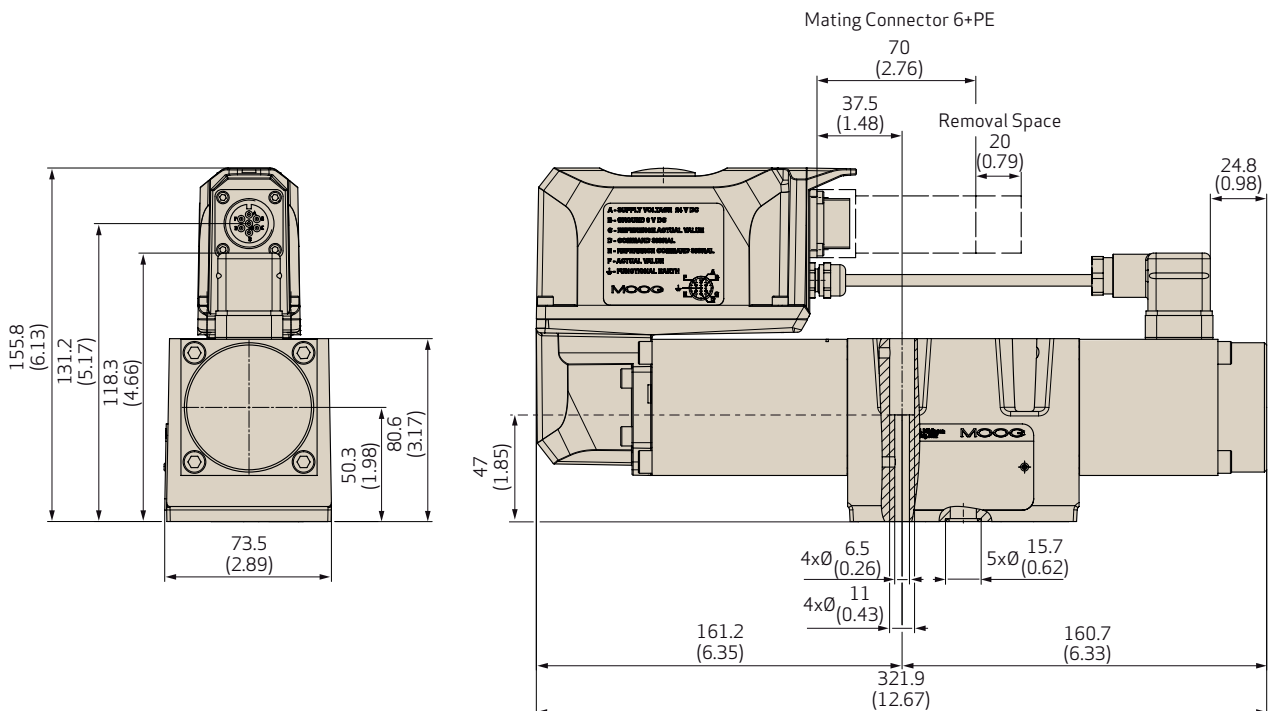

## ELECTRONICS

## Pin Assignment for Valves with 6-pole + PE Connector, Pin Contacts

According to EN 175201-804, mating connector (type R or S, metal) with leading protective earth pin (⊕)

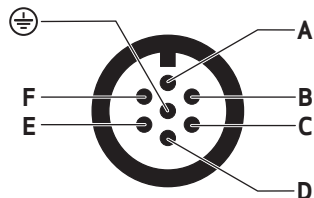

Pin	Pin Assignment	Signal Type <sup>1)</sup>	
		Voltage Floating	Current Floating <sup>2)</sup>
A	Supply voltage	$U_{A-B} = 24 V_{DC}$ (18 to 32 $V_{DC}$ ) referenced to GND (reverse polarity protected against GND)	
B	GND	Power ground	
C	Reference point actual value	Reference for Pin F	
D	Command signal - spool position	$U_{in} = U_{D-E}$ $R_{in} = 10 k\Omega$	$I_{in} = I_D = -I_E$ $R_{in} = 200 \Omega$ $I_{max} = \pm 25 mA$
E	Reference point input rated command	Reference for pin D <sup>2)</sup>	
F	Actual value - spool position	$U_{F-C} = -10$ to 10 V; $U_{F-C}$ is proportional to the spool position; 0 V corresponds to the spool center position	$I_{out} = 4$ to 20 mA referenced to PIN C; $I_{out}$ is proportional to the spool position; 12 mA corresponds to the spool center position; the output is short-circuit-proof; $R_L = 0$ to 500 $\Omega$
⊕	Protective earth (PE)	Connected with valve body	

1) Signal ranges see next page.

2) The potential difference between pins D or E referenced to pin B must be between -15 and +32 V.



## ELECTRONICS

## Ordering Codes and Signals for Valves with 6-pole + PE Connector

Ordering code position 10	Command signal $\pm 100\%$ spool position		Actual value $\pm 100\%$ spool position	
H	$U_D - U_E$	-10 to +10 V	$U_F - U_C$	-10 to +10 V
X	$I_D$	-10 to +10 mA	$I_F$	4 to 20 mA
E	$I_D$	4 to 20 mA	$I_F$	4 to 20 mA

Note: See chapter "Ordering Code" for complete ordering information

### Command Signal Current Floating, Ordering Code X or E

The spool position is proportional to  $I_D = -I_E$ .

#### 4/3-way configuration with two solenoids:

For a command signal  $I_D = 20$  mA (code E) or +10 mA (code X) the spool moves to 100 % P→A and B→T.

For a command signal  $I_D = 12$  mA (code E) or 0 mA (code X) the spool is in the defined center position.

#### 4/2-way configuration with single solenoid:

For a command signal of  $I_D = 20$  mA (code E) or +10 mA (code X) the spool moves to 100 % P→B and A→T.

For a command signal  $I_D = 4$  mA (code E) or 0 mA (code X) the spool is in the defined center position.

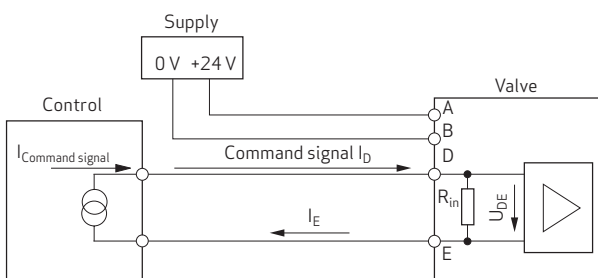

### Actual Value 4 to 20 mA, Ordering Code X or E

The signal can be used for monitoring and fault detection purposes. The spool position is proportional to  $I_{out}$ . The spool position corresponds to 4 to 20 mA.

#### 4/3-way configuration with two solenoids:

At 12 mA the spool is in center position. 20 mA corresponds to 100 % valve opening P→A and B→T.

#### 4/2-way configuration with single solenoid:

At 4 mA the spool is in center position. 20 mA corresponds to 100 % valve opening P→B and A→T.

A cable fault is detected by  $I_{out} = 0$  mA.

Actual value  $U_{out} = 2$  to 10 V with resistor  $R_L = 500 \Omega$  (0.25 W) provided by the customer.

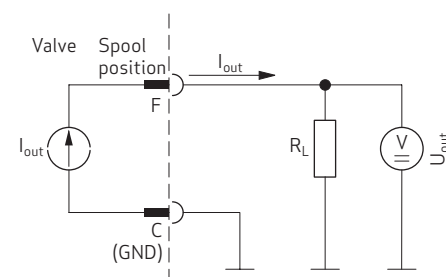

## ELECTRONICS

### Ordering Codes and Signals for Valves with 6-pole + PE Connector

#### Command Signal Voltage Floating, Ordering Code H

The spool position is proportional to  $U_D - U_E$ .

#### 4/3-way configuration with two solenoids:

For a command signal  $U_D - U_E = +10\text{ V}$  the spool moves to 100 % P  $\rightarrow$  A and B  $\rightarrow$  T.

For a command signal  $U_D - U_E = 0\text{ V}$  the spool is in the defined center position.

#### 4/2-way configuration with single solenoid:

For a command signal  $U_D - U_E = +10\text{ V}$  the spool moves to 100 % P  $\rightarrow$  B and A  $\rightarrow$  T.

For a command signal  $U_D - U_E = 0\text{ V}$  the spool is in the defined center position.

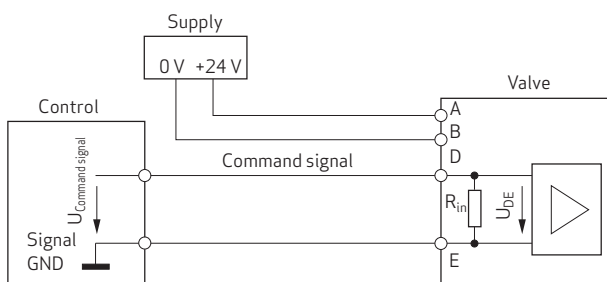

#### Actual Value -10 to +10 V, Ordering Code H

The spool position is proportional to  $U_{out}$ . The spool position corresponds to -10 to +10 V. At 0 V the spool is in center position.

#### 4/3-way configuration with two solenoids:

+10 V corresponds to 100 % valve opening P  $\rightarrow$  A and B  $\rightarrow$  T.

#### 4/2-way configuration with single solenoid:

+10 V corresponds to 100 % valve opening P  $\rightarrow$  B and A  $\rightarrow$  T.

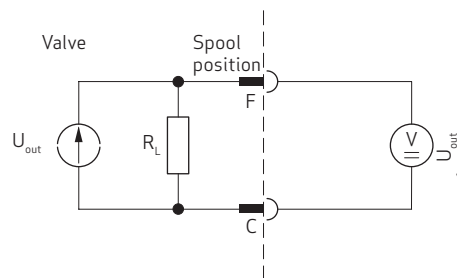

For ordering code H, do not connect pin C to Power GND (pin B).

# FLOW CALCULATION

When the valve is open the resulting flow is dependent not only on the spool position, (i.e. the opening cross section of the valve), but also on the pressure drop at the individual lands. When the valve is deflected at 100 %, it delivers the rated flow with the rated pressure drop. The rated flow of a proportional valve corresponds to a pressure drop of 5 bar (75 psi) per land, equating to 10 bar (150 psi) for two lands. When a valve is opened at 100 %, the flow can be calculated as a function of the actual pressure drop with the aid of the formula below, or it can be taken from the diagram.

When operating the valves close to these application limits, it is necessary to drill the ports to the maximum possible diameters (see „Port Pattern of Mounting Surface“ on pages 10 and 15).

$$Q = Q_N \cdot \sqrt{\frac{\Delta p}{\Delta p_N}}$$

- Q [l/min (gpm)]    actual flow
- Q<sub>N</sub> [l/min (gpm)]    rated flow
- Δp [bar (psi)]    actual pressure drop for two lands
- Δp<sub>N</sub> [bar (psi)]    rated pressure drop for two lands

## Flow Chart

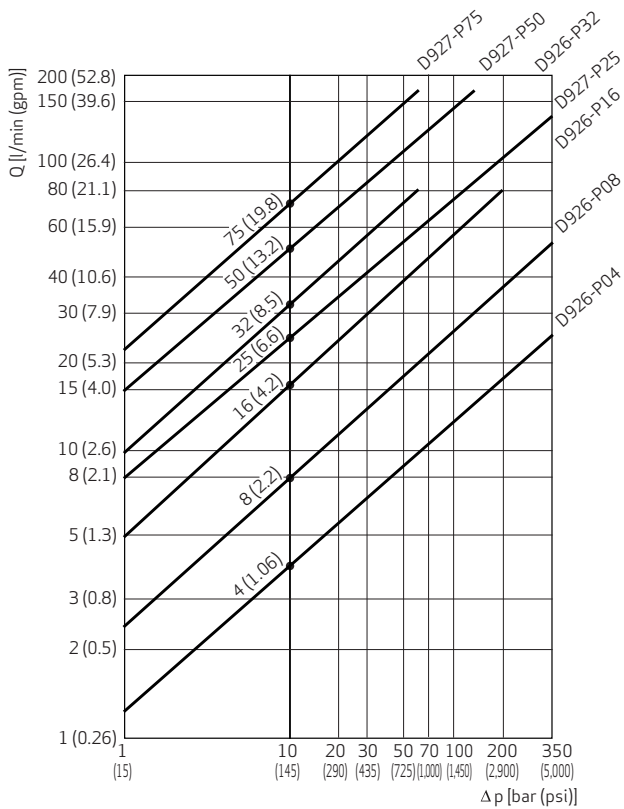

## ACCESSORIES AND SPARE PARTS

### Spare Parts

Part Name	Series	Description	Material	Part Number
Service sealing set	D926	O-rings for ports P, T, A, B, Y, consisting of: 4 pieces inner Ø 9.25 mm (0.36 in) x Ø 1.8 mm (0.07 in) 1 piece inner Ø 7.65 mm (0.3 in) x Ø 1.8 mm (0.07 in)	FKM 90 Shore	B97215-V630F63
			HNBR 90 Shore	B97215-H630F61
	D927	O-rings for ports P, T, T1, A, B, Y, consisting of: 5 pieces inner Ø 12.4 mm (0.49 in) x Ø 1.8 mm (0.07 in) 2 pieces inner Ø 15.6 mm (0.61 in) x Ø 1.8 mm (0.07 in)	FKM 90 Shore	B97215-V681-10
			HNBR 90 Shore	B97215-H681-10

### Accessories

Part Name	Series	Description	Remark	Part Number
Mating connector	D926, D927	Cable with straight mating connector 6-pole + PE	5, 10, 20 or 25 m, e.g. for 5 m specify 005, other length upon request	C21033-xxx-001
		Mating connector, elbow 6-pole + PE	In accordance with EN 175201-804, type S, metal, IP65, crimp contact Ø 0.75 to 1.5 mm <sup>2</sup> (0.0012 to 0.0023 in <sup>2</sup> ), conus Ø 12.2 mm (0.48 in), cable Ø 8 to 12 mm (0.31 to 0.47 in), sealing element Ø 9 to 13 mm (0.35 to 0.51 in)	B97069-061
		Mating connector, straight 6-pole + PE	In accordance with EN 175201-804, type R, metal, IP65, crimp contact Ø 0.75 to 1.5 mm <sup>2</sup> (0.0012 to 0.0023 in <sup>2</sup> ), conus Ø 12.2 mm (0.48 in), cable Ø 8 to 12 mm (0.31 to 0.47 in), sealing element Ø 9 to 13 mm (0.35 to 0.51 in)	B97007-061
Mounting screws	D926	4 pieces M5x30, ISO 4762-10.9, tightening torque 6.8 Nm (60 lbf in)	-	-
	D927	4 pieces M6x55, ISO 4762-10.9, tightening torque 11 Nm (97 lbf in)	-	A03665-060-055
Shipping plate	D926	1 piece	-	B46035-001
	D927		-	A40503

### Documents

Title	Description	Remark	Part Number
Mounting and Installation Instruction D926/D927 Series Valves	Installation Instructions	Visit <a href="http://www.moog.com">www.moog.com</a> to download a document using the part number in a search	B97072-936
Technical Note TN 353	Protective Grounding and Electrical Shielding of Hydraulic Valves with Integrated Electronics		CA58437
Technical Note TN 494	Maximum Permissible Length of Electric Cables for Valves with Integrated Electronics		CA48851

## ACCESSORIES AND SPARE PARTS

### Installation Drawings

#### Mating Connector, Straight 6-pole + PE

In accordance with EN 175201-804, type R, metal, IP65, crimp contact  $\varnothing 0.75$  to  $1.5 \text{ mm}^2$  (0.0012 to  $0.0023 \text{ in}^2$ ), conus  $\varnothing 12.2 \text{ mm}$  (0.48 in), cable  $\varnothing 8$  to  $12 \text{ mm}$  (0.31 to 0.47 in), sealing element  $\varnothing 9$  to  $13 \text{ mm}$  (0.35 to 0.51 in)

Part number B97007-061

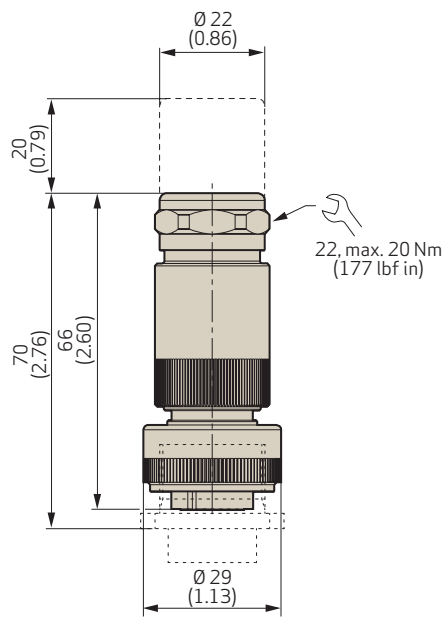

#### Mating Connector, Elbow 6-pole + PE

In accordance with EN 175201-804, type S, metal, IP65, crimp contact  $\varnothing 0.75$  to  $1.5 \text{ mm}^2$  (0.0012 to  $0.0023 \text{ in}^2$ ), conus  $\varnothing 12.2 \text{ mm}$  (0.48 in), cable  $\varnothing 8$  to  $12 \text{ mm}$  (0.31 to 0.47 in), sealing element  $\varnothing 9$  to  $13 \text{ mm}$  (0.35 to 0.51 in)

Part number B97069-061

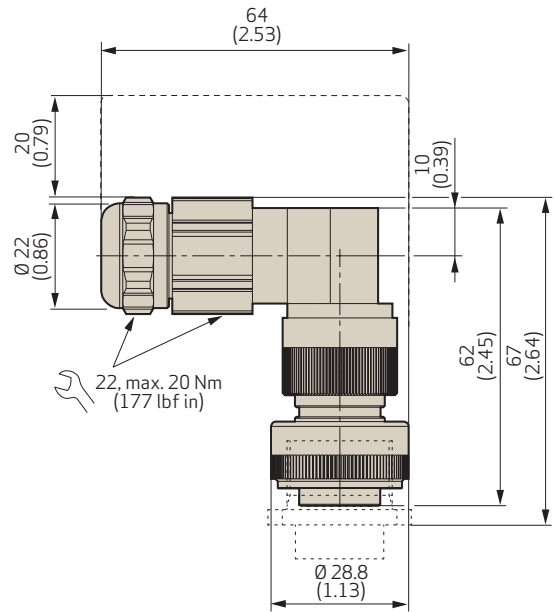

## NOTES

# ORDERING CODE

**Model Number**  
(assigned at the factory)

**Type Designation**

D92\_ .... P K M S 2 - 0

Size	
6	Size 03
7	Size 05

**Model Designation**

1 Valve Type	
P	Proportional valve with integrated digital electronics

2 Rated Flow per Spool Land for $\Delta p_N = 5 \text{ bar (75 psi)}$			
	D926	D927	
04	●	–	4 l/min (1.06 gpm)
08	●	–	<b>8 l/min (2.1 gpm)</b>
16	●	–	<b>16 l/min (4.2 gpm)</b>
25	–	●	25 l/min (6.6 gpm)
32	●	–	<b>32 l/min (8.5 gpm)</b>
50	–	●	50 l/min (13.2 gpm)
75	–	●	<b>75 l/min (19.8 gpm)</b>

3 Maximum Operating Pressure	
K	350 bar (5,000 psi)

4 Spool Design		
	D926	D927
L	1.5 to 3 % positive overlap, progressive flow characteristic	
1	4/3-way	15 % positive overlap, progressive flow characteristic
		10 % positive overlap, progressive flow characteristic
2	4/3-way	P→A, P→B: 15 % overlap; A→T, B→T: 12 % underlap, progressive flow characteristic
		P→A, P→B: 10 % overlap; A→T, B→T: 7 % underlap, progressive flow characteristic
3	1.5 to 3 % positive overlap, progressive flow characteristic, A:B = 2:1	
4	15 % positive overlap, progressive flow characteristic, A:B = 2:1	
5	4/3-way	P→A, P→B: 15 % overlap; A→T, B→T: 12 % underlap, progressive flow characteristic, A:B = 2:1
		P→A, P→B: 10 % overlap; A→T, B→T: 7 % underlap, progressive flow characteristic, A:B = 2:1
6	4/2-way	15 % positive overlap, progressive flow characteristic
		10 % positive overlap, progressive flow characteristic
7	4/2-way	P→A, P→B: 15 % overlap; A→T, B→T: 12 % underlap, progressive flow characteristic
		P→A, P→B: 10 % overlap; A→T, B→T: 7 % underlap, progressive flow characteristic

13 Enable Function	
0	No enable signal

11 Supply Voltage	
2	24 V <sub>DC</sub> , for more information, see section "Electronics"

10 Command Signals		
	Command Signal	Actual Value
H	±10 V	±10 V
E	4 to 20 mA	4 to 20 mA
X	±10 mA	4 to 20 mA
J	±10 V	±10 V with deadband compensation
W	4 to 20 mA	4 to 20 mA with deadband compensation
U	±10 mA	4 to 20 mA with deadband compensation

9 Valve Connector X1	
S	6-pole + PE EN 175201-804

8 Seal Material	
H	HNBR
V	FKM

7 Y Port	
0	No Y port, $P_{Tmax} \text{ D926} = 280 \text{ bar (4,000 psi)}$ ; $P_{Tmax} \text{ D927} = 250 \text{ bar (3,600 psi)}$
3	With Y port, $p_{Tmax} = 350 \text{ bar (5,000 psi)}$ (only D926)

6 Spool Position Without Electrical Supply	
M	Center position <sup>1)</sup>

5 Proportional Solenoid	
8	2 proportional solenoids, LVDT on A side
0	4/2-way: Single proportional solenoid and LVDT on A side

Note: Preferred options marked in **bold**.

<sup>1)</sup>For spools with 1.5 to 3 % overlap, the spring centered position may not correspond with the hydraulic zero position.

# MORE PRODUCTS. MORE SUPPORT.

Moog designs a range of motion control products to complement those featured in this document. Moog also provides service and support for all of our products. For more information, contact the Moog facility closest to you.

Australia  
+61 3 9561 6044  
Service + 61 3 8545 2140  
info.australia@moog.com  
service.australia@moog.com

India  
+91 80 4057 6666  
Service +91 80 4057 6604  
info.india@moog.com  
service.india@moog.com

Singapore  
+65 677 36238  
Service +65 651 37889  
info.singapore@moog.com  
service.singapore@moog.com

Brazil  
+55 11 3572 0400  
info.brazil@moog.com  
service.brazil@moog.com

Ireland  
+353 21 451 9000  
info.ireland@moog.com

Spain  
+34 902 133 240  
info.spain@moog.com

Canada  
+1 716 652 2000  
info.canada@moog.com

Italy  
+39 0332 421 111  
Service 800 815 692  
info.italy@moog.com  
service.italy@moog.com

Sweden  
+46 31 680 060  
info.sweden@moog.com

China  
+86 512 5350 3600  
info.china@moog.com  
service.china@moog.com

Japan  
+81 46 355 3767  
info.japan@moog.com  
service.japan@moog.com

Turkey  
+90 216 663 6020  
info.turkey@moog.com

France  
+33 1 4560 7000  
Service +33 1 4560 7015  
info.france@moog.com  
service.france@moog.com

Korea  
+82 31 764 6711  
info.korea@moog.com  
service.korea@moog.com

United Kingdom  
+44 (0) 1684 858000  
Service +44 (0) 1684 278369  
info.uk@moog.com  
service.uk@moog.com

Germany  
+49 7031 622 0  
Service +49 7031 622 197  
info.germany@moog.com  
service.germany@moog.com

Luxembourg  
+352 40 46 401  
info.luxembourg@moog.com

USA  
+1 716 652 2000  
info.usa@moog.com  
service.usa@moog.com

Hong Kong  
+852 2 635 3200  
info.hongkong@moog.com

The Netherlands  
+31 252 462 000  
info.thenetherlands@moog.com  
service.netherlands@moog.com

For product information, visit [www.moog.com/industrial](http://www.moog.com/industrial)

Moog is a registered trademark of Moog Inc. and its subsidiaries.  
All trademarks as indicated herein are the property of Moog Inc. and its subsidiaries.  
©2024 Moog Inc. All rights reserved. All changes are reserved.

Moog Proportional Valves D926 and D927 Series  
KEM/Rev. C, January 2024, Id. CDL39437-en