

USER MANUAL FOR

PILOT-OPERATED PROPORTIONAL VALVES WITH INTEGRATED DIGITAL ELECTRONICS

D67xK SERIES



Rev. -, May 2012

PROPORTIONAL VALVES FOR ELECTROHYDRAULIC POSITION,
SPEED, PRESSURE AND FORCE CONTROL EVEN FOR HIGH DYNAMIC
REQUIREMENTS

copyright

© 2012 Moog GmbH
Hanns-Klemm-Strasse 28
71034 Böblingen
Germany
+49 7031 622-0-
Fax: +49 7031 622-100
E-Mail: Info.germany@moog.com
Internet: <http://www.moog.com/industrial>

All rights reserved.

No part of this user manual may be reproduced in any form (print, photocopies, microfilm, or by any other means) or edited, duplicated, or distributed with electronic systems without the prior written consent of Moog.

Offenders will be held liable for the payment of damages.

Subject to change without notice.

Table of Contents

Index of Tables	viii
Index of figures	x
1 General Information	1
1.1 Notes on user manual	1
1.1.1 Subject to change without notice and validity	2
1.1.2 Completeness	2
1.1.3 Storage location	2
1.1.4 Typographical conventions	3
1.1.5 Structure of the warning notes	4
1.2 Supplemental documents	5
1.3 Intended operation	5
1.4 Selection and qualification of personnel	7
1.5 Structural modifications	8
1.6 Environmental protection	9
1.6.1 Acoustical Emissions	9
1.6.2 Disposal	9
1.7 Responsibilities	10
1.8 Warranty and liability	11
1.9 Declaration of conformity	12
1.10 Registered marks and trademarks	13
2 Safety	14
2.1 Handling in accordance with safety requirements	14
2.2 Occupational safety and health	15
2.3 General safety instructions	16
2.4 ESD	16
2.5 Pressure limitation	16
3 Product Description	17
3.1 Function and mode of operation	17
3.1.1 Pilot pressure	17
3.1.2 Representative depiction of the valve	18
3.1.3 Permanent magnet linear force motor	19
3.1.4 Valve electronics and valve software	20
3.1.4.1 Valve status	21
3.1.5 Signal interfaces	22
3.1.5.1 Connector X1	23
3.1.5.2 Fieldbus connectors X3 and X4	24
3.1.5.3 Service connector X10	24
3.2 Safety function/fail-safe	25
3.2.1 Mechanical fail-safe function	26
3.2.1.1 Valves with fail-safe functions F, D and M	26
3.2.1.2 Valves with fail-safe functions H and K	27
3.2.1.3 Mechanical fail-safe state	27
3.2.1.4 Fail-safe identification	27
3.2.1.5 spool identification	27
3.2.2 Electrical fail-safe function	28

3.2.3 Fail-safe events	28
3.2.3.1 Shutdown/failure of the supply voltage	29
3.2.3.2 Signals at the enable input	29
3.2.3.3 Drop in the pilot pressure p_X	29
3.2.3.4 Settable fault reaction	30
3.2.3.5 Control commands	30
3.2.4 Restarting the valve	31
3.3 Hydraulics	32
3.3.1 Flow control (Q-control)	33
3.3.2 Valve configurations and hydraulic symbols	34
3.3.2.1 2-way and 2/2-way operation	34
3.3.2.2 4-way and 3-way operation	35
3.3.2.3 5-way operation	36
3.3.3 Control type ports X and Y	37
3.3.3.1 Pilot pressure port X	37
3.3.3.2 Leakage port Y	37
3.3.3.3 Pilot identification	37
3.3.4 Electrical and hydraulic zero positions	38
3.4 Control	39
3.4.1 Signal types for set-point and actual value	40
3.4.1.1 Signal type identification	41
3.4.1.2 Flow control command inputs	42
3.4.2 Analog actual value output	46
3.4.3 Digital enable input	46
3.5 Configuration software	47
3.6 Moog Valve and Pump Configuration Software	48
3.7 Nameplate	48
4 Characteristic curves	49
4.1 Flow diagram (4-way operation)	49
4.2 Flow signal characteristic curve	51
5 Transportation and Storage	52
5.1 Checking/unpacking a delivery	54
5.2 Scope of delivery of the valve	54
5.3 Storage	55
6 Mounting and Connection to the Hydraulic System	56
6.1 Dimensions (installation drawings)	57
6.2 Mounting surface	57
6.2.1 Surface quality	57
6.2.2 Holes in mounting surface	57
6.3 Mounting the valve	58
6.3.1 Tools and materials required	58
6.3.2 Specification for installation screws for the valves	58
6.3.3 Procedure	59
7 Electrical connection	61
7.1 Safety instructions for installation and maintenance	61
7.1.1 Protective grounding and electrical shielding	63
7.1.2 Moog Valve and Pump Configuration Software	65
7.2 Block diagram	66
7.3 Arrangement of connectors	67

7.4 Connector X1	69
7.4.1 Pin assignment of connector X1.....	69
7.4.2 Mating connector for connector X1	69
7.4.3 Power supply.....	70
7.5 Analog inputs/outputs	70
7.5.1 Analog inputs.....	70
7.5.1.1 Signal types.....	71
7.5.2 Analog outputs	73
7.6 Digital inputs/outputs	74
7.6.1 Digital input.....	74
7.6.2 Digital outputs.....	74
7.7 Digital signal interface	75
7.7.1 SSI transducer.....	75
7.7.1.1 Pin assignment SSI transducer connector X2.....	76
7.8 Fieldbus connectors X3 and X4	77
7.8.1 CAN connectors	77
7.8.1.1 Technical data for the CAN bus interface.....	77
7.8.1.2 Pin assignment, CAN connectors.....	78
7.8.2 Profibus-DP connectors	78
7.8.2.1 Technical data for the Profibus-DP interface.....	79
7.8.2.2 Pin assignment, Profibus-DP connectors.....	80
7.8.3 EtherCAT connectors	80
7.8.3.1 Technical data for the EtherCAT interface	81
7.8.3.2 Pin assignment, EtherCAT connectors	82
7.9 Analog input connectors X5, X6 and X7	83
7.9.1 Pin assignment, analog input connectors X5, X6 and X7	83
7.9.2 Signal types.....	84
7.9.3 Input resistances	85
7.10 Service connector X10	86
7.11 General notes on wiring	88
7.11.1 Tools and materials required.....	88
7.11.2 Procedure.....	89
7.11.3 Wiring of supply lines, evaluation of digital and analog signals.....	89
7.12 Protective grounding, equipotential bonding, and shielding	90
7.12.1 Overview	90
7.12.2 Equipotential bonding and protective grounding	91
7.12.2.1 General principles	92
7.12.2.2 Protective conductor.....	92
7.12.2.3 Ground loops.....	93
7.12.3 Machines with deficient equipotential bonding.....	94
7.12.4 Electrical shielding.....	94
7.12.4.1 Cables	94
7.12.4.2 Connecting the shield.....	95
7.12.4.3 Insulated shielding.....	97
7.12.4.4 Cable routing	97
7.13 Permissible lengths for connection cables	98
7.13.1 Introduction.....	98
7.13.2 Typical values for copper cables	98
7.13.2.1 Resistance of cable	98
7.13.2.2 Capacitance of cable.....	98
7.13.3 24 V supply cables	99
7.13.3.1 Voltage drop per unit length	99
7.13.3.2 Examples of the voltage drop of supply cables	100
7.13.4 Analog signal cables	101

7.13.5 Digital signal cables.....	102
7.13.5.1 Digital signal input cables.....	102
7.13.5.2 Digital signal output cables.....	102
7.13.5.3 Fieldbus cables.....	102
7.14 Wiring connector X1.....	102
7.14.1 Single-ended command signals.....	103
7.14.2 Conversion of actual value output signals I_{out}	104
7.14.2.1 Valves with 7-pin connector X1.....	104
7.15 Wiring SSI transducers (X2).....	105
7.15.1 SSI master mode.....	105
7.16 Wiring CAN networks.....	106
7.16.1 Cable lengths and cable cross sections.....	109
7.16.1.1 Suitable cable types for CAN networks.....	109
7.16.2 Permissible number of CAN bus nodes.....	110
7.16.3 CAN module address (node ID).....	110
7.16.4 CAN transmission rate.....	110
7.17 Wiring Profibus-DP networks (X3, X4).....	111
7.17.1 Cable lengths and cable cross sections.....	112
7.17.1.1 Suitable cable types for Profibus-DP networks.....	113
7.17.2 Permissible number of Profibus nodes.....	113
7.17.3 Profibus-DP module address (node ID).....	113
7.17.4 Profibus-DP transmission rate.....	113
7.18 Wiring EtherCAT networks (X3, X4).....	114
7.18.1 Suitable cable types for EtherCAT networks.....	115
7.18.2 Permissible number of EtherCAT nodes.....	116
7.18.3 EtherCAT module address (node ID).....	116
7.18.4 EtherCAT transmission rate.....	116
7.19 Wiring analog inputs (X5, X6, X7).....	117
7.20 Electrical start-up.....	119
7.21 Electromagnetic compatibility (EMC).....	120
7.22 Communication via the Moog Valve and Pump Configuration Software.....	121
8 Start-up.....	123
8.1 Preparations.....	126
8.2 Start-up of the valves.....	127
8.3 Configuration of the valves.....	128
8.3.1 Configuration via the fieldbus interface.....	128
8.3.1.1 Configuration with the machine controller.....	128
8.3.1.2 Configuration with the Moog Valve and Pump Configuration Software.....	129
8.3.2 Configuration via the service interface.....	130
8.3.3 Factory setting of the valves.....	131
8.3.4 Storing of parameters.....	131
8.4 Filling and flushing the hydraulic system.....	132
8.5 Start-up of the hydraulic system.....	133
8.5.1 Venting the actuator.....	133
9 Operation.....	134
9.1 Preparations for operation.....	137
9.2 Operation of the valve.....	138
9.3 Shutting down the valve.....	138

10 Service	140
10.1 Removing of the valves	143
10.1.1 Tools and materials required	143
10.1.2 Removing	145
10.2 Maintenance	146
10.2.1 Checking and replacing the port O-rings	146
10.2.1.1 Tools and materials required	146
10.2.1.2 checking and replacing the O-rings	146
10.3 Troubleshooting	147
10.3.1 Leaks	147
10.3.1.1 Leak at the valve connecting surface	147
10.3.1.2 Leak at the linear force motor screw plug	148
10.3.2 No hydraulic response by the valve	148
10.3.3 Instability of the external control loop	149
10.3.4 Instability of the internal valve control loops	149
10.3.4.1 Flow control	149
10.4 Repair	150
11 Technical Data	152
11.1 Nameplates	154
11.1.1 Model number and type designation	156
11.1.2 LSS address	163
11.1.3 Data matrix code	163
11.2 Electromagnetic compatibility (EMC)	163
11.3 Technical data D671K – ISO 4401-05/NG10	164
11.3.1 Mounting surface	165
11.3.1.1 Mounting pattern of mounting surface	165
11.3.2 Data D671K with direct-operated pilot valve D633K	166
11.4 Technical data D672K – ISO 4401-07/NG16	175
11.4.1 Mounting surface	176
11.4.1.1 Mounting pattern of mounting surface	176
11.4.2 Data D672K with direct-operated pilot valve D633K	177
11.5 Technical data D673K – ISO 4401-08/NG25	186
11.5.1 Mounting surface	187
11.5.1.1 Mounting pattern of mounting surface	187
11.5.2 Data D673K with direct-operated pilot valve D633K	188
11.6 Technical data D674K – ISO 4401-08/NG25	197
11.6.1 Mounting surface	198
11.6.1.1 Mounting pattern of mounting surface	198
11.6.2 Data D674K with direct-operated pilot valve D633K	199
11.7 Technical data D675K – ISO 4401-10/NG32	208
11.7.1 Mounting surface	209
11.7.1.1 Mounting pattern of mounting surface	209
11.7.2 Data D675K with direct-operated pilot valve D633K	210
12 Accessories, Spare Parts, and Tools	222
12.1 Accessories for valves in the D67XK series	222
12.2 Tools for valves in the D67XK series	224
12.3 NG-dependent accessories and spare parts	225
12.3.1 Proportional valves in the D671K series	225
12.3.2 Proportional valves in the D672K series	226
12.3.3 Proportional valves in the D673K and D674K series	226
12.3.4 Proportional valves in the D675K series	227

13 Ordering Information	228
14 Keyword index.....	230
15 Appendix.....	247
15.1 Abbreviations, symbols and identification letters	247
15.2 Additional literature.....	249
15.2.1 Fundamentals of hydraulics	249
15.2.2 CAN fundamentals	250
15.2.3 Profibus fundamentals.....	250
15.2.4 EtherCAT fundamentals	250
15.2.5 Moog publications	250
15.3 Quoted standards	250
15.3.1 CiA DSP	250
15.3.2 TIA/EIA	251
15.3.3 IEC	251
15.3.4 IEEE	251
15.3.5 ISO, ISO/IEC	251
15.3.6 DIN	251
15.3.7 EN	252
15.3.8 EN ISO	253
15.3.9 ISO	253
15.4 Quoted directives	253
15.5 Explosion-proof connectors.....	255

Index of Tables

Tab. 1: Marking of D67XK series	5
Tab. 2: Valve status	21
Tab. 3: Existing signal interfaces	23
Tab. 4: Fail-safe events	28
Tab. 5: Benefits of the different signal types for analog command inputs	40
Tab. 6: Signal types command value and spool position signal in the type designation	41
Tab. 7: Specification for installation screws for the valves.....	58
Tab. 8: Allocation of interfaces to connectors.....	68
Tab. 9: Technical data for the CAN bus interface	77
Tab. 10: Technical data for the Profibus-DP interface	79
Tab. 11: Technical data for the EtherCAT interface.....	81
Tab. 12: Input resistances X5, X6, X7	85
Tab. 13: Benefits of the different signal types for analog inputs	89
Tab. 14: Examples of the voltage drop of supply cables as a function of the cable length for a cable cross section of 0.75 m ²	100
Tab. 15: Recommendation for maximum cable lengths in CAN networks, depending on the transmission rate	109
Tab. 16: Recommendation for maximum cable lengths in CAN networks, depending on the cable cross section and the number n of CAN bus nodes	109
Tab. 17: Maximum permissible stub cable lengths in CAN networks	109
Tab. 18: Specification of electrical data for CAN bus cables	109
Tab. 19: Suitable cable types for CAN networks	109
Tab. 20: Recommendation for maximum cable lengths in Profibus-DP networks, depending on the transmission rate	112
Tab. 21: Specification of electrical data for Profibus-DP cables (as per type A).....	113
Tab. 22: Suitable cable types for Profibus-DP networks.....	113
Tab. 23: Assignment of Ethernet/EtherCAT signals with mixed connector types	115
Tab. 24: Overview of technical data for the series and variants	152
Tab. 25: Spool type in the type designation.....	156
Tab. 26: Rated flow variant in the type designation	157
Tab. 27: Maximum permissible operating pressure in the type designation	157
Tab. 28: Spool variant in the type designation.....	158
Tab. 29: Pilot valve variant in the type designation.....	158
Tab. 30: Spool position in case of failure, D67X with pilot valve D633K.....	159
Tab. 31: Variant of pilot pressure and leakage port in the type designation	160
Tab. 32: Seal material variant in the type designation	160
Tab. 33: Variant of the valve connector X1 in the type designation.....	161
Tab. 34: Signal types command value and spool position signal in the type designation	161

Tab. 35: Variant of the fieldbus connector X3 and X4 in the type designation	162
Tab. 36: Technical data D671K with direct-operated pilot valve D633K	166
Tab. 37: Technical data D672K with direct-operated pilot valve D633K	177
Tab. 38: Technical data D673K with direct-operated pilot valve	188
Tab. 39: Technical data D674K with direct-operated pilot valve D633K	199
Tab. 40: Technical data D675K with direct-operated pilot valve D633K	210
Tab. 41: Accessories and tools for all proportional valves in the D67XK series.....	222
Tab. 42: Spare parts for valves in the D67XK series	224
Tab. 43: Spare parts and accessories in the D671K series with direct-operated pilot valve D633K	225
Tab. 44: Spare parts and accessories in the D672K series with direct-operated pilot valve D633K	226
Tab. 45: Spare parts and accessories in the D673K and D674K series with direct-operated pilot valve D633K.....	226
Tab. 46: Spare parts and accessories in the D675K series with direct-operated pilot valve D633K	227
Tab. 47: Abbreviations, symbols and identification letters	247

Index of figures

Fig. 1:	Representative depiction of a two-stage proportional valve with directly-operated pilot valve D633K.....	18
Fig. 2:	Representative depiction of the permanent magnet linear motor (D633K).....	19
Fig. 3:	Flow control (Q-control) block diagram.....	33
Fig. 4:	5-way operation with mechanical fail-safe function F (hydraulic symbol).....	36
Fig. 5:	Examples of the electrical and hydraulic zero positions of different spools in the flow signal characteristic curve.....	38
Fig. 6:	Floating flow control command input ± 10 V (circuit and characteristic curve).....	42
Fig. 7:	Floating flow control command input ± 10 mA (circuit and characteristic curve).....	42
Fig. 8:	Floating flow control command input 4–20 mA (circuit and characteristic curve).....	44
Fig. 9:	Flow diagram (4-way operation) D671K to D675K.....	49
Fig. 10:	Flow signal characteristic curve with equal electrical and hydraulic zero positions.....	51
Fig. 11:	Design for measuring the flow signal characteristic curve.....	51
Fig. 12:	Valve D671K, flow-signal characteristic curve.....	51
Fig. 13:	Block diagram of the valve electronics.....	66
Fig. 14:	Arrangement of connectors on the valve electronics housing (maximum equipment specification).....	67
Fig. 15:	Assignment of service connector X1 (7-pin).....	69
Fig. 16:	SSI transducer connector X2.....	76
Fig. 17:	CAN connectors X3 and X4.....	78
Fig. 18:	Profibus DP connectors X3 and X4.....	80
Fig. 19:	EtherCAT connectors X3 and X4.....	82
Fig. 20:	Analog input connectors X5, X6 and X7.....	83
Fig. 21:	Equivalent circuit diagram of analog input.....	85
Fig. 22:	Service connector X10 (M8, 3-pin).....	86
Fig. 23:	Equipotential bonding and protective grounding of machines (see also EN 60204-1) and electrical shielding of our valves with integrated electronics.....	91
Fig. 24:	Connecting the shield to the control cabinet's wall (detail A from Fig. 23).....	95
Fig. 25:	Connecting the cable shield via connector to the control cabinet's wall (detail A from Fig. 23).....	96
Fig. 26:	Connecting the insulated shielding to the control cabinet's wall (detail A from Fig. 23).....	97
Fig. 27:	Voltage drop on the supply cable.....	99
Fig. 28:	Wiring of the 7-pin connector X1.....	102
Fig. 29:	Circuit for single-ended command signals.....	103
Fig. 30:	Circuit for converting the actual value output signals I_{out} (for valves with 7-pin connector X1).....	104
Fig. 31:	Wiring diagram with SSI transducer.....	105
Fig. 32:	Signals between valve and a 16-bit SSI transducer (example).....	105
Fig. 33:	CAN wiring diagram.....	107
Fig. 34:	Connection of the CAN bus valve with terminal resistor.....	107
Fig. 35:	Connection of the valve to a PC via the CAN bus interface (fieldbus connector X3).....	108

Fig. 36: Profibus-DP wiring diagram	112
Fig. 37: Connection valve Profibus with terminal resistor	112
Fig. 38: EtherCAT wiring diagram.....	115
Fig. 39: Twisted-pair litz wires in Ethernet/EtherCAT cables with M12 connectors	115
Fig. 40: Connecting a 2-wire transducer to analog input connectors X5, X6 or X7	118
Fig. 41: Connecting a 3-wire transducer to analog input connectors X5, X6 or X7	118
Fig. 42: Connecting a 4-wire transducer to analog input connectors X5, X6 or X7	118
Fig. 43: Connection of the valve to a PC via the service interface (service connector X10)	130
Fig. 44: MOOG Global Support Logo	150
Fig. 45: Nameplate (example)	154
Fig. 46: Ex nameplate (example).....	155
Fig. 47: Holes in the mounting surface for D671K series (dimensions in mm and (in)).....	165
Fig. 48: Installation drawing for D671K (dimensions in mm and (in))	168
Fig. 49: Installation drawing for D671K (dimensions in mm and (in))	170
Fig. 50: Valve D671K, flow-signal characteristic curve.....	172
Fig. 51: Step response for D671K valves, standard	173
Fig. 52: Frequency response for D671K valves, standard.....	173
Fig. 53: Step response for D671K valves, trimmed	174
Fig. 54: Frequency response for D671K valves, trimmed.....	174
Fig. 55: Holes in the mounting surface for the D672K series (dimensions in mm and (in)).....	176
Fig. 56: Installation drawing for D672K (dimensions in mm and (in))	179
Fig. 57: Installation drawing for D672K (dimensions in mm and (in))	181
Fig. 58: Valve D672K, flow-signal characteristic curve.....	183
Fig. 59: Step response for D672K valves, standard	184
Fig. 60: Frequency response for D672K valves, standard.....	184
Fig. 61: Step response for D672K valves, trimmed	185
Fig. 62: Frequency response for D672K valves, trimmed.....	185
Fig. 63: Holes in the mounting surface for the D673K series (dimensions in mm and (in)).....	187
Fig. 64: Installation drawing for D673K (dimensions in mm and (in))	190
Fig. 65: Installation drawing for D673K (dimensions in mm and (in))	192
Fig. 66: Valve D673K, flow-signal characteristic curve.....	194
Fig. 67: Step response for D673K valves, standard	195
Fig. 68: Frequency response for D673K valves, standard.....	195
Fig. 69: Step response for D673K valves, trimmed	196
Fig. 70: Frequency response for D673K valves, trimmed.....	196
Fig. 71: Holes in the mounting surface for the D674K series (dimensions in mm and (in)).....	198
Fig. 72: Installation drawing for D674K (dimensions in mm and (in))	201
Fig. 73: Installation drawing for D674K (dimensions in mm and (in))	203
Fig. 74: Valve D674K, flow-signal characteristic curve.....	205

Fig. 75: Step response for D674K valves, standard	206
Fig. 76: Frequency response for D674K valves, standard.....	206
Fig. 77: Step response for D674K valves, trimmed	207
Fig. 78: Frequency response for D674K valves, trimmed.....	207
Fig. 79: Holes in the mounting surface for the D675K series (dimensions in mm and (in)).....	209
Fig. 80: Installation drawing for D675K (dimensions in mm and (in))	212
Fig. 81: Installation drawing for D675K (dimensions in mm and (in))	214
Fig. 82: Valve D675K, flow-signal characteristic curve 1000 l/min	216
Fig. 83: Valve D675K, flow-signal characteristic curve 1500 l/min	217
Fig. 84: Step response for D675K valves, standard, stub shaft spool K10.....	218
Fig. 85: Frequency response for D675K valves, standard, stub shaft spool K10.....	218
Fig. 86: Step response for D675K valves, trimmed, stub shaft spool K10.....	219
Fig. 87: Frequency response for D675K valves, trimmed, stub shaft spool K10.....	219
Fig. 88: Step response for D675K valves, standard, stub shaft spool K15.....	220
Fig. 89: Frequency response for D675K valves, standard, stub shaft spool K15.....	220
Fig. 90: Step response for D675K valves, trimmed, stub shaft spool K15.....	221
Fig. 91: Frequency response for D675K valves, trimmed, stub shaft spool K15.....	221

1 General Information

1.1 Notes on user manual

This user manual refers exclusively to the standard models of the valves of the Type series D671K to D675K. It includes the most important notes in order to operate these valves properly and safely.

⇒ Chap. "1.3 Intended operation", page 5

⇒ Chap. "2.1 Handling in accordance with safety requirements", page 14

Notes on user manual



Special models of the valves custom-made for specific customers, such as for example valves with axis control function (ACV), are not explained in this user manual.

Please contact Moog or one of its authorized service centers for information on these special models.

The contents of this user manual and the product-related hardware and software documentation relevant to the particular application must be read, understood and followed in all points by each person responsible for machine planning, assembly and operation before work with and on the valves is started. This requirement applies in particular to the safety instructions.

⇒ Chap. "1.1.2 Completeness", page 2

⇒ Chap. "1.4 Selection and qualification of personnel", page 7

⇒ Chap. "1.7 Responsibilities", page 10

⇒ Chap. "2.1 Handling in accordance with safety requirements", page 14

This user manual has been prepared with great care in compliance with the relevant regulations, state-of-the-art technology and our many years of knowledge and experience, and the full contents have been generated to the best of the authors' knowledge.

However, the possibility of error remains and improvements are possible.

Please feel free to submit any comments about possible errors and incomplete information to us.



This user manual is also available in German.

On request, translation into other languages is possible.

1.1.1 Subject to change without notice and validity

The information contained in this user manual is valid and correct at the moment of release of this version of the user manual. The version number and release date of this user manual are indicated in the footer.

Changes may be made to this user manual at any time and without notice.

Subject to change without notice and validity of the user manual

1.1.2 Completeness

This user manual is only complete in conjunction with the product-related hardware and software documentation required for the relevant application.

Available documentation:

⇒ [Chap. "1.2 Supplemental documents", page 5](#)

Completeness of the user manual

1.1.3 Storage location

This user manual together with all the product-related hardware and software documentation relevant to the particular application must at all times be kept close at hand to the valve or the higher-level machine.

Storage location for the user manual

1.1.4 Typographical conventions

DANGER



warns about an imminent danger to health and life. Failure to observe this warning can cause severe injuries or even death.

- ▶ Make absolutely sure to heed the measures described to prevent this danger

Typographical conventions

WARNING



warns about a possible situation dangerous to health. Failure to observe this warning can cause severe injuries or even death.

- ▶ Make absolutely sure to heed the measures described to prevent this danger

CAUTION



warns about a possible situation dangerous to health. Failure to observe this warning can cause slight injuries.

- ▶ Make absolutely sure to heed the measures described to prevent this danger

CAUTION

warns about possible property and environmental damage. Failure to observe this warning can cause damage to the product, a machine or the environment.

- ▶ Make absolutely sure to heed the measures described to prevent this danger



Identifies important notes that contain usage tips and special useful information, but no warnings.

Important

- or - Identifies listings
 - ▶ Identifies an action that must be taken
 - ⇒ Identifies references to another chapter, another table or figure
 - "..." Denotes headings to the chapters or titles of the documents to which reference is being made
 - Blue text Identifies hyperlinks
 - 1., 2., ... Identifies steps in a procedure that must be performed in consecutive order
 - '...'
- Identifies parameters for valve software (e.g.: 'Node ID') or the valve status (e.g.: 'ACTIVE')

1.1.5 Structure of the warning notes

In the present user manual, danger symbols draw attention to remaining dangers in the handling of valves that cannot be constructively avoided. The actions for avoiding danger described must be adhered to.

The warning notes used are structured as follows:

SIGNAL WORD		Structure of warning notes
	<p>Type of danger Consequences ▶ Prevention</p>	
<ul style="list-style-type: none"> • Warning symbol: draws attention to the danger • Signal word: indicates the severity of the danger <ul style="list-style-type: none"> - Meaning of the signal words: ⇒ Chap. "1.1.4 Typographical conventions", page 3 • Type of danger: names the type and source of danger • Consequences: describes the consequences in case of non-observance • Prevention: specifies the actions to prevent this danger. 		Explanation structure of warning notes

1.2 Supplemental documents



The supplemental documents mentioned here are not included in the valves' scope of delivery. They are available as an accessory.
⇒ Chap. "12 Accessories, Spare Parts, and Tools", page 222

The PDF files of the supplementing documents can be downloaded from the following link:
<http://www.moog.com/industrial/literature>

Supplemental documents

1.3 Intended operation



The valves may be operated exclusively within the framework of the data and applications specified in the user manual.
Any other or more extensive use is not permitted.

Intended operation

The valves D671K, D672K, D673K, D674K, and D675K are combined in the D67XK series. The valves are electrical operating resources for hazardous areas, protection type "de" (d flameproof enclosure according to IEC 60079-1, e increased safety according to IEC 60079-7).

Identification of D67XK series:

II 2G Ex d e IIC TX Gb				D67XK	
	TX	Temperature environment		Temperature hydraulic fluid	
Sealing material: FKM	T4	-20 °C	60 °C	-20 °C	80 °C
	T5	-20 °C	55 °C	-20 °C	55 °C
	T6	-20 °C	45 °C	-20 °C	45 °C
Sealing material: HNBR	T4	-20 °C	60 °C	-20 °C	75 °C
	T5	-20 °C	55 °C	-20 °C	55 °C
	T6	-20 °C	45 °C	-20 °C	45 °C
Sealing material: T-ECOPUR Temperature range down to -40 °C on request	T6	-40 °C	35 °C	-40 °C	35 °C

Tab. 1: Marking of D67XK series

The valves may only be operated as a component part of a higher-level overall system, for example in a machine.

They may be used only as control elements to control flow and/or pressure in hydraulic circuits that regulate position, speed, pressure and power.

The valves are intended for use with mineral-oil-based hydraulic oils. Use with other media requires our prior approval.

Correct, reliable and safe operation of the valves requires qualified project planning as well as proper utilization, transportation, storage, mounting, removal, electric and hydraulic connection, start-up, configuration, operation, cleaning and maintenance.

The valves may only be started up when the following is ensured:

- The higher-level machine with all its installed components complies with the latest versions of the relevant national and international regulations, standards and guidelines (such as, for example, the EU Machinery Directive, the regulations of the trade association and of TÜV or VDE).
- The valves and all the other installed components are in a technically fault-free and operationally reliable state.
- No signals that can lead to uncontrolled movements in the machine are transmitted to the valves.

Intended operation also includes the following:

- Observation of this user manual
- Handling of the valves in accordance with safety requirements
⇒ [Chap. "2.1 Handling in accordance with safety requirements", page 14](#)
- Adherence to all the inspection and maintenance instructions of the manufacturer and the operator of the machine
- Observation of all product-related hardware and software documentation relevant to the particular application
- Observation of all safety standards of the manufacturer and the operator of the machine relevant to the particular application
- Observation of all the latest versions of the national and international regulations, standards and guidelines relevant to the particular application (such as, the EU Machinery Directive, ATEX directive, the regulations of the trade association and of TÜV or VDE)

1.4 Selection and qualification of personnel

CAUTION

Danger of personal injury and damage to property!

Working with and on the valves without the required basic mechanical, hydraulic, and electrical knowledge may cause injuries or parts may be damaged.

- ▶ Only properly qualified and authorized users may work with and on the valves.
- ▶ ⇒ [Chap. "1.4 Selection and qualification of personnel", page 7](#)

Selection and qualification of personnel



Maintenance work by the user on explosion proof valves is not permitted. Intervention by third parties will invalidate the ex certification.

Qualified users are specialized personnel with the required knowledge and experience who have been trained to carry out such work. The specialized personnel must be able to recognize and avert the dangers to which they are exposed when working with and on the valves.

In particular, these specialized personnel must be authorized to operate, earth/ground and mark hydraulic and electrical devices, systems and power circuits in accordance with the standards of safety engineering. Project planners must be fully conversant with automation safety concepts.

Warranty and liability claims in the event of personal injury or damage to property are among others excluded if such injury or damage is caused when the valves are worked on or handled by non-qualified personnel.

⇒ [Chap. "1.8 Warranty and liability", page 11](#)

Qualified users

1.5 Structural modifications

DANGER



Danger of explosion!

To guarantee safe operation in hazardous areas:

- ▶ Structural modifications of the valves or to accessories may only be made by MOOG GmbH or by an authorized MOOG service center.
- ▶ Intervention by third parties will invalidate the ex certification.

CAUTION

Electrostatic discharge!

To guarantee safe operation in hazardous areas.

The additional painting of our explosion-proof valves by third parties is a structural change. In case of additional painting, due to the possible accumulation of electrostatic charges, the corresponding provisions of the DIN EN 60079-0 standard must be adhered to.

CAUTION

Risk of damage!

The valves and the accessories can be damaged due to structural changes.

- ▶ Due to the complexity of the internal components, structural changes to the valves and to the accessories may only be made by MOOG GmbH or an authorized MOOG service center.

Structural modifications

Warranty and liability claims for personal injury and damage to property are excluded if they are caused by unauthorized or improperly performed structural modifications or other interventions.

⇒ [Chap. "1.8 Warranty and liability", page 11](#)

1.6 Environmental protection

1.6.1 Acoustical Emissions

WARNING

**Damage to hearing!**

Depending on the application, significant levels of noise may be generated when the valves are operated.

- ▶ Always protect yourself with hearing protection when working on the valves.

**Environmental protection:
Acoustical Emissions**

Generally speaking, the valves do not generate harmful acoustic emissions when they are used for their intended purpose.

1.6.2 Disposal

WARNING

**Risk of injury!**

In order to prevent injuries and other damage to health, please observe the following recommendations.

- ▶ Wear appropriate safety clothing.
- ▶ Wear protective gloves and safety glasses.
- ▶ ⇒ [Chap. "2.2 Occupational safety and health", page 15](#)

It is essential to comply with the relevant national waste disposal regulations and environmental protection provisions when disposing of valves, spare parts or accessories, packaging that is no longer needed, hydraulic fluid or auxiliary materials and substances used for cleaning!

If necessary, the items to be disposed of must be expertly dismantled into individual parts, separated into individual materials and placed in the corresponding waste system or earmarked for recycling.

The valve contains among others the following materials:

- Electronic components
- Adhesives and casting compounds
- Parts with electro-plated surfaces
- Permanent-magnet materials
- Hydraulic fluid
- Assorted metals and plastics

**Environmental protection
Disposal**

1.7 Responsibilities

The manufacturer and the operator of the machine are responsible for ensuring that work with and on the valves and handling of the valves is planned and performed in accordance with the directions given in this user manual and in the product-related hardware and software documentation relevant to the particular application.

The manufacturer and the operator of the machine are in particular responsible for ensuring the following:

- Selection and training of personnel
⇒ [Chap. "1.4 Selection and qualification of personnel", page 7](#)
- Intended operation
⇒ [Chap. "1.3 Intended operation", page 5](#)
- Handling in accordance with safety requirements
⇒ [Chap. "2.1 Handling in accordance with safety requirements", page 14](#)
- Taking and monitoring of the occupational safety and health measures required for the particular application
⇒ [Chap. "2.2 Occupational safety and health", page 15](#)
- Observation of all safety standards of the manufacturer and the operator of the machine relevant to the particular application
- Observation of the latest versions of the relevant national and international regulations, standards and guidelines (such as, for example, the EU Machinery Directive, the regulations of the trade association and of TÜV or VDE) in the configuration, construction and operation of the machine with all its installed components
- Installation of suitable safety devices for limiting the pressure at the hydraulic ports
⇒ [Chap. "2.5 Pressure limitation", page 16](#)
- Compliance with the preconditions for satisfying the EMC protection requirements
⇒ [Chap. "11.2 Electromagnetic compatibility \(EMC\)", page 163](#)
- Use of the valves in a technically faultless and operationally safe state
- Prevention of unauthorized or improperly performed structural modifications, repairs or maintenance
⇒ [Chap. "1.5 Structural modifications", page 8](#)
⇒ [Chap. "10 Service", page 140](#)
- Definition and observation of the application-specific inspection and maintenance instructions
- Adherence to all the technical data relating to the storage, transportation, installation, removal, connection, start-up, configuration, operation, cleaning, maintenance or elimination of any faults, in particular the ambient conditions and the data pertaining to the hydraulic fluid used
⇒ [Chap. "11 Technical Data", page 152](#)
- Proper storage, transportation, installation, removal, connection, start-up, configuration, operation, cleaning, maintenance, elimination of any faults or disposal
- Use of suitable and faultless accessories and of suitable and faultless spare parts
⇒ [Chap. "12 Accessories, Spare Parts, and Tools", page 222](#)
- Handy and accessible storage of this user manual and of the product-related hardware and software documentation relevant to the particular application
⇒ [Chap. "1.1.3 Storage location", page 2](#)

Responsibility of the manufacturer and the operator of the machine

1.8 Warranty and liability

Our General Terms and Conditions of Sale and Payment always apply. These are made available to the buyer at the latest on conclusion of the contract.

Among other things, warranty and liability claims for personal injury and damage to property are excluded if they are caused by one or more of the following:

- Work with and on the valves carried out by or the valves handled by non-qualified personnel
⇒ [Chap. "1.4 Selection and qualification of personnel", page 7](#)
- Non-intended operation
⇒ [Chap. "1.3 Intended operation", page 5](#)
- Handling not in accordance with safety requirements
⇒ [Chap. "2.1 Handling in accordance with safety requirements", page 14](#)
- Omission of the occupational safety and health measures required for the particular application
⇒ [Chap. "2.2 Occupational safety and health", page 15](#)
- Failure to observe this user manual or the product-related hardware and software documentation relevant to the particular application
- Failure to observe the safety standards of the manufacturer and the operator of the machine relevant to the particular application
- Failure to observe the latest versions of the relevant national and international regulations, standards and guidelines (such as, for example, the EU Machinery Directive, the regulations of the trade association and of TÜV or VDE) in the configuration, construction and operation of the machine with all its installed components
- Omission of suitable safety devices for limiting the pressure at the hydraulic ports
⇒ [Chap. "2.5 Pressure limitation", page 16](#)
- Failure to comply with the preconditions for satisfying the EMC protection requirements
⇒ [Chap. "11.2 Electromagnetic compatibility \(EMC\)", page 163](#)
- Use of the valves in a state that is not technically faultless or not operationally safe
- Unauthorized or improperly performed structural modifications, repairs or maintenance
⇒ [Chap. "1.5 Structural modifications", page 8](#)
⇒ [Chap. "10 Service", page 140](#)
- Failure to adhere to the inspection and maintenance instructions of the manufacturer and the operator of machine
- Failure to adhere to all the technical data relating to the storage, transportation, installation, removal, connection, start-up, configuration, operation, cleaning, maintenance or elimination of any faults, in particular the ambient conditions and the data pertaining to the hydraulic fluid used
⇒ [Chap. "11 Technical Data", page 152](#)
- Improper storage, transportation, installation, removal, connection, start-up, configuration, operation, cleaning, maintenance, elimination of any faults or disposal
- Use of unsuitable or defective accessories or of unsuitable or defective spare parts
⇒ [Chap. "12 Accessories, Spare Parts, and Tools", page 222](#)
- Catastrophes caused by foreign objects or force majeure

Exclusion of warranty and liability

1.9 Declaration of conformity

A declaration of conformity in accordance with IEC 60079 for the control valves of the D67XK series has been created and is depicted in this user manual.

Declaration of conformity

MOOG GmbH
Hanns-Klemm-Str. 28
D-71034 Böblingen

MOOG

Division Industry

Declaration of conformity

as defined by directive 2014/34/EU (ATEX), Annex X

Herewith we declare that the

Series of Servovalves D67xKxxxx, D94xKxxxx

(detailed model & serial number is referenced on the delivery note)

are in conformance with the provisions of the directive 2014/34/EU (ATEX).

The admission of the series is registered under **BVS 11 ATEX E 122 X**
by DEKRA EXAM GmbH, Dinnendahlstrasse 9, 44809 Bochum, Germany (0158)
The monitoring body of the QM system is TÜV Süd (0123)

Applied harmonized standards in particular:

- EN 60079-0:2012 / Explosive atmospheres -
A11:2013 Equipment - General requirements
- EN 60079-1:2014 Electrical apparatus for potentially explosive atmospheres -
Flameproof enclosures "d".
- EN 60079-7:2007 Electrical apparatus for potentially explosive atmospheres -
Increased safety "e".

Moog GmbH
Hanns-Klemm-Str. 28, D-71034 Böblingen
Tel.: +49 7031 622-0

Gunter Kilgus
General Manager

Richard Kohse
Quality Manager
Representative for ATEX directive 94/9/EC

Böblingen, 20.04.2016

1.10 Registered marks and trademarks

Moog and Moog Global Support® are registered trademarks of Moog Inc. and its subsidiaries.

Registered marks and trademarks

Microsoft® and Windows® are either registered trademarks or trademarks of the Microsoft® Corporation in the USA and/or other countries.



All the product and company names mentioned in this user manual are possibly proprietary names or trademarks of the respective manufacturers. The use of these names by third parties for their own purposes may infringe the rights of the manufacturers. The absence of the symbols ® or ™ does not indicate that the name is free from trademark protection.

2 Safety

2.1 Handling in accordance with safety requirements



It is the responsibility of the manufacturer and the operator of the machine to ensure that the valves are handled in accordance with safety requirements.

Handling in accordance with safety requirements

CAUTION



Danger of personal injury and damage to property due to unexpected operation!

As in any electronic control system, the failure of certain components in valves as well might lead to an uncontrolled and/or unpredictable operational sequence.

- ▶ If automatic control technology is to be used, the user should, in addition to all the potentially available standards or guidelines on safety-engineering installations, consult the manufacturers of the components used in great depth.

In order to ensure that the valves are handled in accordance with safety requirements and operated without faults, it is essential to observe the following:

- All the safety instructions in the user manual
- All the safety instructions in the product-related hardware and software documentation relevant to the particular application
- All the safety instructions in the safety standards of the manufacturer and the operator of the machine relevant to the particular application
- All the relevant national and international safety and accident prevention regulations, standards and guidelines, such as for example the safety regulations of the trade association, of TÜV or VDE and the ATEX Directive 94/9/EC and ATEX Directive 1999/92/EC, in particular the following standards pertaining to the safety of machinery:
 - EN ISO 12100
 - EN 982
 - EN 563
 - EN 60204
 - EN 60079-0
 - EN 60079-1
 - EN 60079-7

Observing the safety instructions and the safety and accident prevention regulations, standards and guidelines will help to prevent accidents, malfunctions and damage to property!

2.2 Occupational safety and health

DANGER



Risk of poisoning and injury!

Contact with hydraulic fluids can damage your health (e.g. eye injuries, skin and tissue damage, poisoning in case of inhaling).

- ▶ Wear protective gloves and safety glasses.
- ▶ If nevertheless hydraulic fluid gets into your eyes or on your skin, consult a doctor immediately.
- ▶ When handling hydraulic fluids, observe the safety provisions applicable to the hydraulic fluid used.

Occupational safety and health measures and equipment

WARNING



Danger of injury due to falling objects!

Falling objects, such as valves, tools, or accessories, can cause injury.

- ▶ Wear appropriate safety clothing, e.g. safety shoes.

WARNING



Danger of burning!

Valves and hydraulic port lines can become very hot during operation. Fingers and hands can suffer severe burn injuries when touching the valve or the connection cable.

- ▶ Allow the valve and the connection cable to cool off before contact.
- ▶ Wear appropriate safety clothing, e.g. safety gloves.

WARNING



Damage to hearing!

Depending on the application, significant levels of noise may be generated when the valves are operated.

- ▶ Always protect yourself with hearing protection when working on the valves.

2.3 General safety instructions

CAUTION

Risk of damage!

In order to prevent damage to the valves or to the machine, heed the following points:

- ▶ Values specified in the technical data must be adhered to.
- ▶ Values specified on the nameplate must be adhered to.
- ▶ ⇒ [Chap. "11 Technical Data", page 152](#)

General safety instructions



This user manual and the product-related hardware and software documentation relevant to the particular application must be inserted in the machine's operating instructions.

2.4 ESD

CAUTION

Risk of damage!

Electrical discharges can damage internal device components.

- ▶ Protect the valve, accessories and spare parts against static charging. In particular, avoid touching the connector contacts.

ESD

2.5 Pressure limitation

WARNING

**Danger of personal injury and damage to property!**

The operation of the valves at pressure that is too high on the hydraulic connections can cause injuries and damage to the machine.

- ▶ Pressure-limiting valves or other comparable safety devices, for example, must be installed to limit the pressure at all the hydraulic ports to the specified maximum operating pressure. Maximum operating pressure:
⇒ [Chap. "11 Technical Data", page 152](#)

Safety devices for pressure limitation

3 Product Description

3.1 Function and mode of operation

The valves in the D671K to D675K series are two-stage proportional valves with a direct-operated pilot valve (Fig. 1, D633K with permanent linear motor). The valves are throttle valves for 2-, 3-, 4-, 5- or even 2/2x2-way applications.

Function and mode of operation of the valves

The valves are suitable for electrohydraulic position, speed, pressure and force control even for high dynamic requirements. They control flow and/or control pressure.

The valve electronics with a PWM driver end stage and a 24 V direct current supply are integrated into the valve.

The digital valve electronics are installed in the electronic housing in vibration-decoupled design so that they are not sensitive to shock and vibration.

For a detailed description of how these work, see

⇒ Chap. "3.1.2 Representative depiction of the valve", page 18

⇒ Chap. "3.3.1 Flow control (Q-control)", page 33

3.1.1 Pilot pressure

If large flows are required with a high valve pressure difference, a correspondingly high pilot pressure must be selected to overcome the flow forces.

Pilot pressure

For reliable function of the valves, we recommend the following pilot pressure p_x :

For valves with stub shaft spool $p_x \geq p_P$

For valves with standard spool $p_x \geq 0.3 \times p_P$

whereby

p_P = pressure on the P port of the valve (pressure supply)

The control pressure specified in the technical data must be adhered to.

⇒ Chap. "11.1 Nameplates", Digit 3, Maximal permissible operating pressure, page 157

Hydraulic safety devices for pressure limitation

Excessive pressure at the hydraulic ports damages the valve and can cause unsafe states in the machine and personal injury.

Safety devices for pressure limitation

Pressure-limiting valves or other comparable safety devices, for example, must be installed to limit the pressure at all the hydraulic ports to the specified maximum operating pressure.

⇒ Chap. "2.5 Pressure limitation"

3.1.2 Representative depiction of the valve

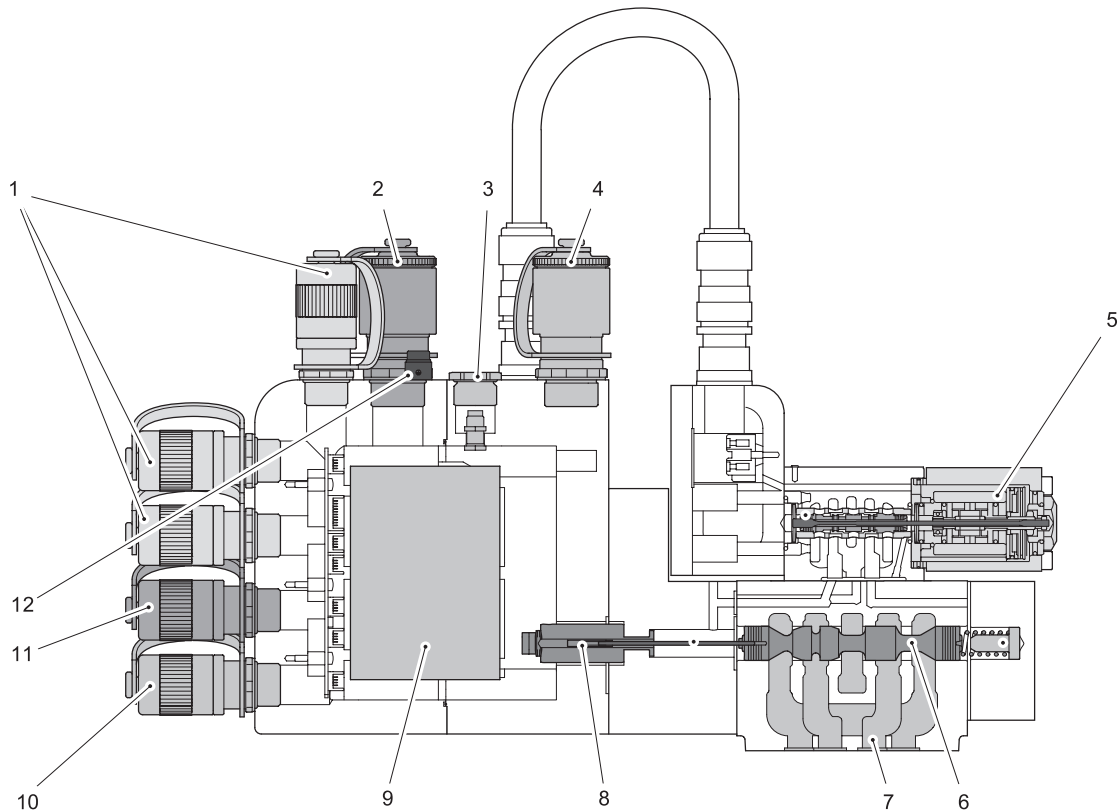
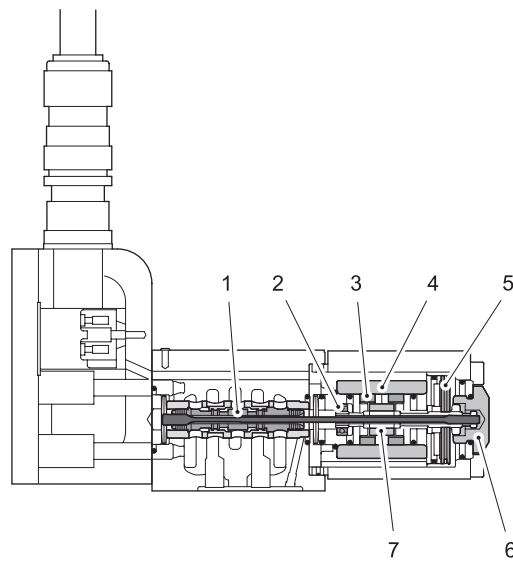

Fig. 1: Representative depiction of a two-stage proportional valve with directly-operated pilot valve D633K

Item	Designation	Additional information
1	Analog input connector X5...X7	The analog input connectors X5...X7 are optionally available.
2	Connector X2 for digital signal interface	The X2 connector is optionally available.
3	Service connector X10	The X10 service connector is only present for valves without CAN bus interface. By default, the X10 service connector is not approved for use in hazardous areas, however on request it is available for use in hazardous areas. Tightening torque: tighten the screw plug of the service connector with tightening torque 9.5 Nm / 7 lbf ft! ⇒ Chap. "7.10 Service connector X10", page 86
4	Connector X1	⇒ Chap. "7.4 Connector X1"
5	Pilot valve D633K	⇒ Chap. "3.1.3 Permanent magnet linear force motor", page 19
6	Main stage spool	
7	Ports	Mounting surface: Mounting pattern D671K (NG10) series ⇒ Fig. 47, page 165 Mounting pattern D672K (NG16) series ⇒ Fig. 55, page 176 Mounting pattern D673K (NG25) series ⇒ Fig. 63, page 187 Mounting pattern D674K (NG25) series ⇒ Fig. 71, page 198 Mounting pattern D675K (NG32) series ⇒ Fig. 79, page 209
8	LVDT	⇒ Chap. "3.3.1 Flow control (Q-control)", page 33
9	Digital valve electronics	⇒ Chap. "3.1.4 Valve electronics and valve software", page 20
10	Fieldbus X3 connector	The fieldbus connectors X3 and X4 are only provided on valves with fieldbus interfaces.
11	Fieldbus X4 connector	⇒ Chap. "7.8 Fieldbus connectors X3 and X4", page 77 ⇒ Chap. "8.3.1 Configuration via the fieldbus interface", page 128
12	Ground terminal	⇒ Chap. "7.12 Protective grounding, equipotential bonding, and shielding"

3.1.3 Permanent magnet linear force motor



Representative depiction of the pilot valve with permanent magnet linear force motor

Fig. 2: Representative depiction of the permanent magnet linear motor (D633K)

Item	Designation
1	Spool
2	Bearing
3	Permanent magnet
4	Coil
5	Centering springs
6	screw plug
7	Armature

A permanent magnet linear force motor is used to drive the valve spool (item 1 in Fig. 2) of the pilot valve.

In contrast to proportional-solenoid drives, the permanent magnet linear force motor can move the spool from the spring-set position in both working directions. This results in high actuating power for the spool while simultaneously providing very good static and dynamic properties.

The permanent magnet linear force motor is a differential motor excited by permanent magnets. Some of the magnetic force is already provided by the permanent magnets. The linear force motor's power demand is thus significantly lower than is the case with comparable proportional-magnet drives.

The linear force motor drives the valve's spool (item 1, Fig. 2). The spool starting position is determined in the de-energized state by the centering springs (item 5 in Fig. 2). The linear force motor enables the spool to be deflected from the starting position in both directions. Here, the actuating power of the linear force motor is proportional to the coil current.

The high forces of the linear force motor and centering springs effect precise spool movement even against flow and frictional forces.

Permanent magnet linear force motor

3.1.4 Valve electronics and valve software

The digital drive and control electronics are integrated in the valve.

These valve electronics contain a microprocessor system that executes all the important functions via the valve software it contains. The digital electronics enable valve control that is both precise and repeatable across the full working range regardless of temperature.

The valve electronics can assume device- and drive-specific functions, such as command signal ramps or dead band compensation.

This can relieve the strain on external machine control and if necessary field-bus communication.

⇒ Chap. "3.5 Configuration software", page 47

⇒ Chap. "8.3 Configuration of the valves", page 128

Integrated digital valve electronics and valve software

3.1.4.1 Valve status

CAUTION



Danger of personal injury and damage to property!

The 'NOT READY' valve status is caused only by a serious, non-rectifiable fault.

- ▶ If the 'NOT READY' valve status occurs, the valve must be sent to MOOG GmbH or one of our authorized MOOG service center for inspection.

The valve's device status is referred to as the valve status.

The valve status can be set or interrogated via the service or fieldbus interface in the valve software. Setting and interrogation can be performed for example with the ⇒ [Chap. "3.6 Moog Valve and Pump Configuration Software"](#), page 48.

Valve status

Valve status	Explanation
'ACTIVE'	The valve is ready for operation and is in closed-loop control operation.
'HOLD'	The valve is ready for operation and is in the electrical fail-safe state on account of a control command. The electrical fail-safe spool position is a closed loop parameterized setting. ⇒ Chap. "3.2.2 Electrical fail-safe function" , page 28
'FAULT HOLD'	The valve is ready for operation and is in the electrical fail-safe state on account of a fault reaction. The electrical fail-safe spool position is a closed loop parameterized setting. ⇒ Chap. "3.2.2 Electrical fail-safe function" , page 28
'DISABLED'	The valve electronics are ready for operation and the valve is in the mechanical fail-safe state on account of a control command. ⇒ Chap. "3.2.1.3 Mechanical fail-safe state" , page 27 Internal parameters can be set and interrogated. The current to the permanent magnet linear force motor is switched off.
'FAULT DISABLED'	The valve electronics are ready for operation and the valve is in the mechanical fail-safe state on account of a fault reaction. Internal parameters can be set and interrogated. ⇒ Chap. "3.2.1.3 Mechanical fail-safe state" , page 27 The current to the permanent magnet linear force motor is switched off.
'INIT'	The valve is switched off, is in the mechanical fail-safe state and can be configured via the service or fieldbus interface. ⇒ Chap. "3.2.1.3 Mechanical fail-safe state" , page 27
'NOT READY'	The valve is not ready for operation and is in the mechanical fail-safe state on account of a serious non-rectifiable fault. ⇒ Chap. "3.2.1.3 Mechanical fail-safe state" , page 27

Tab. 2: Valve status

Fail-safe states and fail-safe events:

⇒ [Chap. "3.2.1.3 Mechanical fail-safe state"](#), page 27

⇒ [Chap. "3.2.3 Fail-safe events"](#), page 28

⇒ [Chap. "11.1 Nameplates"](#), Digit 6, Fail-safe variant, page 159

3.1.5 Signal interfaces

The valves have a connector, X1, with model-dependent analog and digital inputs/outputs. The connectors are an explosion-proof model.

⇒ Chap. "3.1.5.1 Connector X1", page 23

Pin assignment of the connector X1:

⇒ Chap. "7.4.1 Pin assignment of connector X1", page 69

WARNING



Danger of explosion!

To guarantee safe operation in hazardous areas:

- ▶ For mounting and removal of the explosion-proof connectors as well as operation of the valve, the notes and instructions in the "Explosion-proof connectors eXLink, CEAG" operating instructions must absolutely be adhered to.

Depending on the model, the valves can also have an isolated fieldbus interface (connectors X3 and X4) and/or a service interface (service connector X10).

⇒ Chap. "3.1.5.2 Fieldbus connectors X3 and X4", page 24

⇒ Chap. "3.1.5.3 Service connector X10", page 24



For the standard model of the valve, the service interface is not suitable for use in hazardous areas. On request, the service interface is available in an explosion-proof model.

	Interfaces		
	Connector X1	Fieldbus connectors X3 and X4	Service connector X10
Valves without fieldbus interface	•	-	• ¹⁾
Valves with CAN bus interface	•	• ¹⁾	-
Valves with Profibus interface	•	•	• ¹⁾
Valves with EtherCAT interface	•	•	• ¹⁾

Tab. 3: Existing signal interfaces

¹⁾ The valves can be started up and configured via the CAN bus or service interface with the Moog Valve and Pump Configuration Software.
 ⇒ [Chap. "8.3.1.2 Configuration with the Moog Valve and Pump Configuration Software", page 129](#)



It is necessary when ordering the valve to establish whether a fieldbus interface is to be integrated and if necessary one of the above-mentioned fieldbus interfaces is to be selected.

3.1.5.1 Connector X1

Valves without field bus interfaces must be commanded with an analog signal(s) via connector X1.

Valves with field bus interfaces can be controlled either with analog command signals via connector X1 or with digital signals via the field bus interface (connectors X3 and X4).

⇒ [Chap. "3.4 Control", page 39](#)

Different signal types for analog command inputs for flow control can, depending on the model, be selected in the valve.

⇒ [Chap. "3.4.1 Signal types for set-point and actual value", page 40](#)

The valves have an analog actual value output:

⇒ [Chap. "3.4.2 Analog actual value output", page 46](#)

The valves have a digital enable input.

⇒ [Chap. "3.4.3 Digital enable input", page 46](#)

Pin assignment of connector X1:

⇒ [Chap. "7.4.1 Pin assignment of connector X1", page 69](#)

Interfaces for activation signals

Activation of the Valve Command

Analog command inputs

Analog actual value output

Enable input

3.1.5.2 Fieldbus connectors X3 and X4

Valves with field bus interfaces are started up, activated, monitored and configured via the field bus interface (connectors X3 and X4).

⇒ Chap. "8.3.1 Configuration via the fieldbus interface", page 128

To reduce the amount of wiring, the fieldbus interface is provided with two connectors on the valve. The valves can thus be directly looped into the fieldbus, i.e. without the use of external T-pieces.

Valves with CAN bus interfaces can be started up and configured via the CAN bus interface (field bus connector X3) with the Moog Valve and Pump Configuration Software.

⇒ Chap. "8.3.1.2 Configuration with the Moog Valve and Pump Configuration Software", page 129

Plug assignment of the fieldbus connectors X3 and X4:

⇒ Chap. "8.8 Fieldbus connectors X3 and X4", page 77

Fieldbus connectors X3 and X4

3.1.5.3 Service connector X10

Valves without CAN bus interfaces can be started up and configured via the service interface (service connector-X10) with the Moog Valve and Pump Configuration Software.

⇒ Chap. "8.3.2 Configuration via the service interface", page 130

Service connector X10

WARNING



Danger of explosion!

To guarantee safe operation in hazardous areas, the following points must be heeded:

- ▶ In its standard model with screw plug, the service connector X10 is not approved for use in hazardous areas.
- ▶ For mounting of the screw plug of the service connector X10, it must be observed that the gasket and the threads of the screw plug as well as the threads in the electronic housing of the valve are not damaged.
- ▶ In case of damage to the screw plug for the service connector X10 or the threads in the electronic housing, the valve must not be operated.
- ▶ Tightening torque screw plug:
⇒ Chap. "3.1.2 Representative depiction of the valve", page 18



For the standard model of the valve, the service interface is not suitable for use in hazardous areas. On request, the service interface is available in an explosion-proof model.

3.2 Safety function/fail-safe

CAUTION



Risk of injury!

In order to prevent injuries and other damage to health during safety-critical operation, please observe the following recommendations.

⇒ Chap. "2.1 Handling in accordance with safety requirements", page 14

CAUTION



Risk of injury!

In order to prevent injuries and other damage to health during the design, building, and operation of the machine with all installed components, please heed the following instructions.

- ▶ The manufacturer and operator of the machine are responsible for making sure that for safety-critical use, relevant safety standards in the latest version, which serve to avoid damage, are heeded.
- ▶ It is vital among other things to ensure that both the individual components and the complete machine can be rendered in a safe state.

Fail-safe functions

The valve fail-safe functions increase the safety for the user if, for example the valve supply voltage fails or the pilot pressure p_X drops.

There are two different fail-safe functions: mechanical/hydraulic and electrical.

⇒ Chap. "3.2.1 Mechanical fail-safe function", page 26

The valve can be rendered in the fail-safe state by different events.

⇒ Chap. "3.2.3 Fail-safe events", page 28

The mechanical/hydraulic valve fail-safe state is denoted by the fact that the spool of the main stage is in a defined spring-determined position.

⇒ Chap. "3.2.1.3 Mechanical fail-safe state", page 27

Mechanical/hydraulic fail-safe state

The electrical valve fail-safe state is denoted by the fact that the valve is in the 'HOLD' or 'FAULT HOLD' valve status and a preset command signal is corrected by suitable positioning of the main stage spool.

Electrical fail-safe state

It is essential to ensure at the machine end that these fail-safe states result in a safe state in the machine.

The valve must be restarted after it has adopted the fail-safe state.

⇒ Chap. "3.2.4 Restarting the valve", page 31

3.2.1 Mechanical fail-safe function

The valves in the D67XK series are offered with various fail-safe functions. The behavior of the valve in the fail-safe function depends on the fail-safe function selected, the pilot valve, as well as the respective status of pilot pressure and control pressure of the 4/2-way valve.

Mechanical fail-safe functions



The fail-safe function must be specified when the valve is ordered. To see which fail-safe function is integrated into the valve, see the 6th place in the type designation.
⇒ [Chap. "3.2.1.4 Fail-safe identification", page 27](#)

The following fail-safe functions are available:

- Fail-safe function F
- Fail-safe function D
- Fail-safe function H
- Fail-safe function K

3.2.1.1 Valves with fail-safe functions F, D and M

In the case of the fail-safe functions F, D and M, the mechanical setting of the linear force motor or corresponding centering springs at the factory establishes which position the spool assumes in the mechanical fail-safe state.
Position of main stage spool: ⇒ [Tab. 2, page 21](#)

Fail-safe functions F, D and M

The installation drawing/dimensions of the valves are type-dependent
⇒ [Chap. "11 Technical Data", page 152](#)

Hydraulic symbols:

⇒ [Chap. "3.3.2 Valve configurations and hydraulic symbols", page 34](#)

3.2.1.2 Valves with fail-safe functions H and K

The valves with fail-safe function H and K with 4/2-way seat valves are called fail-safe valves.

For applications with proportional valves, for which certain safety specifications apply to prevent danger to man and machine, it must be possible to assume a corresponding spool setting for a safe state.. Therefore, a fail-safe model is available for the multi-stage proportional valves.

After external triggering, this fail-safe function applies a defined spool pressure: safe middle position or open position A→T or B→T.

For fail-safe valves in the D67XK series, both control spaces of the main stage are short-circuited hydraulically via a 4/2-way valve to move the spool of the main state to the safe middle position. The spring-set force moves the spool into the safe fail-safe position.

For fail-safe valves it is possible to monitor whether the main spool is in the safe position:

Installation drawing/dimensions:

⇒ [Chap. "11 Technical Data", page 152](#)

Hydraulic symbols:

⇒ [Chap. "3.3.2 Valve configurations and hydraulic symbols", page 34](#)

Valves with fail-safe functions H and K (fail-safe valves)

3.2.1.3 Mechanical fail-safe state

The valve is in the mechanical fail-safe state when the main stage spool is in a defined spring-determined position.

The spool positions of the main stage in case of failure of the valve electronics or of the control pressure of the 4/2-way valve are described in the tables about the fail-safe function in the technical data.

⇒ [Tab. 30, page 159](#)

Type designation:

⇒ [Chap. "11.1 Nameplates", Digit 6, Fail-safe variant, page 159](#)



All other combinations of pressure and supply voltage give rise to an undefined main stage spool position.

3.2.1.4 Fail-safe identification

The fail-safe identification, i.e. the 6th position in the valve type designation of the proportional or servo valve, indicates which mechanical fail-safe function is integrated in the valve.

Type designation:

⇒ [Chap. "11.1 Nameplates", Digit 6, Fail-safe variant, page 159](#)

Fail-safe identification

3.2.1.5 spool identification

The spool identification, i.e. the 4th position in the valve type designation, indicates which spool version is integrated in the valve.

Type designation:

⇒ [Chap. "11.1 Nameplates", Digit 4, Spool, page 158](#)

spool identification

3.2.2 Electrical fail-safe function

After adopting the 'HOLD' or 'FAULT HOLD' valve status, the valve is in the electrical fail-safe state and a preset command signal is corrected by suitable positioning of the main stage spool.

The command signal can be set or interrogated via the service or fieldbus interface in the valve software. Setting and interrogation can be performed for example with the Moog Valve and Pump Configuration Software.

Command signals that may be applied from an external source via the fieldbus interface or the analog inputs are ignored in the 'HOLD' and 'FAULT HOLD' valve states.

Electrical fail-safe function

3.2.3 Fail-safe events

CAUTION



Danger of personal injury and damage to property!

The 'NOT READY' valve status is caused only by a serious, non-rectifiable fault.

- ▶ If the 'NOT READY' valve status occurs, the valve must be sent to MOOG GmbH or one of our authorized MOOG service center for inspection.

The valve is rendered in the fail-safe state in response to the fail-safe events set out below.

The valve must be restarted after it has adopted the fail-safe state.

⇒ [Chap. "3.2.4 Restarting the valve", page 31](#)

Fail-safe events

Fail-safe event	Fail-safe state		Cause of adoption of fail-safe state		
	Mechan.	Electr.	External event	Settable fault reaction	Control command
Shutdown/failure of the supply voltage	•		•		
Signals on the enable input of the X1 connector (not possible for p/Q function)	•		•		
Drop in the pilot pressure p_x	•		•		
Adoption by valve of valve status	'HOLD'		•		•
	'FAULT HOLD'		•	•	
	'DISABLED'	•			•
	'FAULT DISABLED'	•		•	
	'INIT'	•			•
'NOT READY'	•		• Serious, non-rectifiable fault		

Tab. 4: Fail-safe events

3.2.3.1 Shutdown/failure of the supply voltage

CAUTION

Risk of damage!

After the supply voltage to the valve is shut down, fails or drops below 18 V, the linear force motor is no longer activated by the valve electronics.

- ▶ The cause of the fault must be determined on the machine side and if necessary, eliminated.

Fail-safe due to shutdown/failure of the supply voltage

The valves with fail-safe functions F and D are rendered in the mechanical fail-safe state when the supply voltage is shut down or fails.

With the pilot pressure applied, the mechanical setting of the pilot valve defines which end face of the main stage spool is pressurized with pilot pressure and thus which position the spool assumes in the hydraulic fail-safe state.

Position of main stage spool:

⇒ [Tab. 30, page 159](#)

3.2.3.2 Signals at the enable input

Switching of the valve to fail-safe state can also be triggered by a corresponding signal at the enable input of connector X1. Signals lower than 6.5 V at the enable input switch the valve to fail-safe state.

⇒ [Chap. "3.4.3 Digital enable input", page 46](#)

(Not for valves with pQ function.)

Fail-safe due to signals at the enable input

Pin assignment of connector X1:

⇒ [Chap. "7.4.1 Pin assignment of connector X1", page 69](#)

3.2.3.3 Drop in the pilot pressure p_x

After the pilot pressure p_x has dropped below¹⁾ (depressurized), the main stage spool is pushed by the spring restoring force into the defined spring-determined center position denoting the mechanical fail-safe state of the valves.

Position of main stage spool:

⇒ [Tab. 30, page 159](#)

Fail-safe due to drop in the pilot pressure p_x

¹⁾ Pilot pressure values:

⇒ [Chap. "11.1 Nameplates", Digit 3, Maximal permissible operating pressure, page 157](#)

⇒ [Chap. "11.1 Nameplates", Digit 6, Fail-safe variant, page 159](#)

3.2.3.4 Settable fault reaction

CAUTION



Danger of personal injury and damage to property!

The 'NOT READY' valve status is caused only by a serious, non-rectifiable fault.

- ▶ If the 'NOT READY' valve status occurs, the valve must be sent to MOOG GmbH or one of our authorized MOOG service center for inspection.

Mechanical fail-safe state due to fault reaction

Adoption by the valve of the 'FAULT DISABLED' valve status and thus of the mechanical fail-safe state can be triggered by different events, such as e.g. the supply voltage dropping below 18 V.

It is possible to set in the valve software the event(s) for which the valve is rendered in the 'FAULT DISABLED' valve status.

The setting can be made or interrogated via the service or fieldbus interface in the valve software. Setting and interrogation can be performed for example with the Moog Valve and Pump Configuration Software.

⇒ [Chap. "3.6 Moog Valve and Pump Configuration Software", page 48](#)

The transition of the valve into the 'NOT READY' valve status and therefore into the mechanical fail-safe state is caused by a serious, non-rectifiable fault.

Mechanical fail-safe state due to fault reaction

Electrical fail-safe state due to fault reaction

The transition of the valve into the 'FAULT HOLD' valve status and therefore into the electrical fail-safe state can be initiated by different events, such as e.g. a fault in the electric cable

It is possible to set in the valve software the event(s) for which the valve is rendered in the 'FAULT HOLD' valve status.

The valve state can be set or interrogated via the service or fieldbus interface in the valve software. Setting and interrogation can be performed for example with the Moog Valve and Pump Configuration Software.

⇒ [Chap. "3.6 Moog Valve and Pump Configuration Software", page 48](#)

Electrical fail-safe state due to fault reaction

3.2.3.5 Control commands

The transition of the valve into the 'HOLD', 'DISABLED' and 'INIT' valve states can be initiated by a control command.

Control commands

3.2.4 Restarting the valve

WARNING



Danger of injury due to unexpected machine movements!

In order to avoid injuries and other risks to health on start-up of the valve after a transition into the fail-safe state, please follow the following instructions.

- ▶ The cause of the fault must be determined on the machine side and if necessary, eliminated.
- ▶ It is also necessary to ensure that restarting the valve does not give rise to unintentional or dangerous states in the machine.

Restarting the valve

After shutdown/failure of the supply voltage:

After the transition of the valve into a fail-safe state on account of a shutdown/failure of the supply voltage to the valve, it will be necessary to restart the valve by applying the supply voltage in accordance with the technical data. If necessary, the valve must be returned to the 'ACTIVE' valve status.

After application of an enable signal lower than 6.5 V:

After the transition of the valve into a fail-safe state on account of the application of an enable signal lower than 6.5 V, it will be necessary to restart the valve by applying an enable signal between 8.5 V and 32 V.

After a drop in the pilot pressure p_x :

After the valve has adopted the fail-safe state on account of a drop in the pilot pressure p_x , it will be necessary to restart the valve by applying a higher pilot pressure.

Pilot pressure values:

- ⇒ Chap. "11.1 Nameplates", Digit 3, Maximal permissible operating pressure, page 157
- ⇒ Chap. "11.1 Nameplates", Digit 6, Fail-safe variant, page 159

After transition of the valve into of the 'FAULT DISABLED' or 'FAULT HOLD' valve status:

After transition of the valve into the fail-safe state on account of a transition into the 'FAULT DISABLED' or 'FAULT HOLD' valve status, it can be restarted as follows:

- Acknowledge the fault via the service or fieldbus interface and return the valve to the 'ACTIVE' valve status.
- Set the supply voltage for at least 1 second under defined conditions to zero and then restore the supply voltage in accordance with the technical data. If necessary, the valve must be returned to the 'ACTIVE' valve status.

After transition of the valve into the 'HOLD', 'DISABLED' or 'INIT' valve status:

After the transition of the valve into the fail-safe state on account of adoption of the 'DISABLED' or 'INIT' valve status, it can be restarted as follows:

- Return the valve to the 'ACTIVE' valve status.
- Apply an enable signal less than 6.5 V, then apply an enable signal between 8.5 V and 32 V and return the valve to the 'ACTIVE' valve status.
- For valves without fieldbus interface: set the supply voltage for at least 1 second under defined conditions to zero and then restore the supply voltage in accordance with the technical data.

3.3 Hydraulics

CAUTION**Danger of personal injury and damage to property due to spraying fluids!**

In order to ensure proper operation of the valves and of the machine, heed the following:

- ▶ The correct configuration of the valve with regard to flow and pressure is required.

3.3.1 Flow control (Q-control)

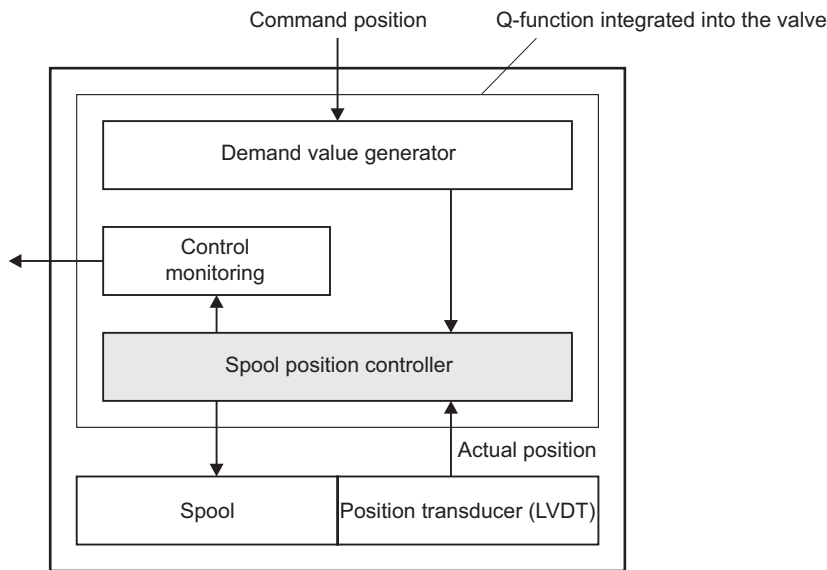

Flow control (Q-control):
Regulation of the position
of main stage spool

Fig. 3: Flow control (Q-control) block diagram

In this operational mode the position of the main stage spool is controlled. The predefined command signal corresponds to a particular spool position. The position of the spool is proportional to the command signal.

The command signal (command position for the main stage spool) is transmitted to the valve electronics. The actual spool position is measured with a position transducer (LVDT) and transmitted to the valve electronics.

Deviations between the predefined command position and the measured actual position of the spool are corrected. The valve electronics activate the pilot valve, which positions the spool accordingly. This process sets a specific flow.

The position command can be influenced by means of parameters in the valve software (e.g., linearization, ramping, dead band, sectionally defined amplification, correction of the zero position).

The parameters can be set or interrogated via the service or field bus interface in the valve software. Setting and interrogation can be performed for example with the Moog Valve and Pump Configuration Software.

The flow rate to be set depends not only on the position of the spool, but also on the pressure difference Δp at the individual control lands.

⇒ [Chap. "3.5 Configuration software", page 47](#)

⇒ [Chap. "4.1 Flow diagram \(4-way operation\)", page 49](#)

Characteristic curves

⇒ [Chap. "11 Technical Data", page 152](#)

3.3.2 Valve configurations and hydraulic symbols

Depending on the model, the following valve configurations are possible:

- 2-way operation
⇒ Chap. "3.3.2.1 2-way and 2/2-way operation", page 34
- 3-way operation
⇒ Chap. "3.3.2.2 4-way and 3-way operation", page 35
- 4-way operation
⇒ Chap. "3.3.2.2 4-way and 3-way operation", page 35
- 5-way operation
⇒ Chap. "3.3.2.3 5-way operation", page 36
- 2/2-way operation
⇒ Chap. "3.3.2.1 2-way and 2/2-way operation", page 34

Valve configurations

3.3.2.1 2-way and 2/2-way operation

Hydraulic symbols of the valves D671K to D675K:

⇒ Chap. "Technical data D671K to D675K, overview", page 152

Fail-safe functions:

⇒ Chap. "3.2.1.1 Valves with fail-safe functions F, D and M", page 26

With 2-way and 2/2x2-way operation the valves can be used to control the flow in one direction (used as throttle valves).

With 2/2x2-way operation the valve can be used in 2-way applications for greater flows.

It is necessary to connect ports P with B and A with T externally for this purpose.

⇒ Chap. "Technical data D671K to D675K, overview", page 152

2-way and 2/2-way operation



The flow directions that are depicted under "Way functions and hydraulic symbols" in the technical data of the corresponding valve must be adhered to.

For the 2/2-way function, the ports X and Y must always be connected.

⇒ Chap. "3.3.3.1 Pilot pressure port X", page 37

⇒ Chap. "3.3.3.2 Leakage port Y", page 37

3.3.2.2 4-way and 3-way operation

Hydraulic symbols of the valves D671K to D675K:

⇒ Chap. "Technical data D671K to D675K, overview", page 152

**4-way- and 3-way function
(Fail-Safe-Function
M and W)**

Fail-safe functions:

⇒ Chap. "3.2.1.1 Valves with fail-safe functions F, D and M", page 26

⇒ Chap. "3.2.1.2 Valves with fail-safe functions H and K", page 27

With 4-way operation the valves can be used to control the flow in ports A and B (used as throttle valves).

Port A or B must be closed in order to obtain 3-way operation.



The flow directions that are depicted under "Way functions and hydraulic symbols" in the technical data of the corresponding valve must be adhered to.

For D671 valves in the 4-way version and with

$Q_N > 60$ l/min, the second tank connection T_1 is required.

Information about whether the valve is delivered with externally or internally-connected leakage connection Y and whether leakage connection Y must be used:

⇒ Chap. "3.3.3.2 Leakage port Y", page 37

3.3.2.3 5-way operation

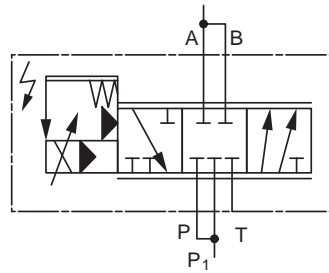

Example NG10

**5-way operation
(fail-safe function F)**

Fig. 4: 5-way operation with mechanical fail-safe function F (hydraulic symbol)

Hydraulic symbols for the D671K valve:

⇒ Chap. "11.3 Technical data D671K – ISO 4401-05/NG10", page 164

Fail-safe functions:

⇒ Chap. "3.2.1.1 Valves with fail-safe functions F, D and M", page 26

⇒ Chap. "3.2.1.2 Valves with fail-safe functions H and K", page 27



The flow directions that are depicted under "Way functions and hydraulic symbols" in the technical data of the corresponding valve must be adhered to.

Information about whether the valve is delivered with externally or internally-connected leakage connection Y and whether leakage connection Y must be used:

⇒ Chap. "3.3.3.2 Leakage port Y", page 37

CAUTION



Danger of personal injury and damage to property!

For the D671K valves in the 5-way version type B80..., T_1 becomes P_1

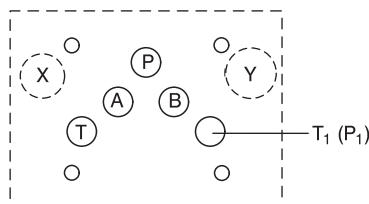

3.3.3 Control type ports X and Y

3.3.3.1 Pilot pressure port X

If the system pressure is subject to heavy fluctuations, external actuation via pilot pressure port X delivers better control precision.

Pilot pressure port X



The valve can be supplied with either an externally or an internally connected pilot pressure port X.

When the valve is ordered, it is specified how this connection is made.

Whether the pilot pressure connection X is used can be read from the 7th digit of the variant designation.

⇒ [Chap. "11.1 Nameplates", Digit 7, Hydraulic control type, Pilot pressure port X and leakage port Y, page 160](#)

3.3.3.2 Leakage port Y

The leakage connection Y is present in all series of the D67XK series; it must be used in the following cases:

Leakage port Y

- always with 2/2x2-way operation
- if high pressure peaks occur in the tank connection T (e.g. caused by other switchable valves in the hydraulic circuit) - without use of the leakage connection Y, they will cause damage to the valve.

The maximum permissible values are specified under "Hydraulic data" in the technical data for the corresponding valve:

⇒ [Chap. "Technical data D671K to D675K, overview", page 152](#)



The valve can be supplied with either an externally or an internally connected pilot pressure port Y.

When the valve is ordered, it is specified how this connection is made.

Whether the pilot pressure connection Y is used can be read from the 7th digit of the variant designation.

⇒ [Chap. "11.1 Nameplates", Digit 7, Hydraulic control type, Pilot pressure port X and leakage port Y, page 160](#)

3.3.3.3 Pilot identification

The pilot identification, i.e. the 7th position in the valve type designation, indicates whether pilot pressure port X and leakage port Y are internally or externally connected.

Pilot identification

Type designation:

⇒ [Chap. "11.1 Nameplates", Digit 7, Hydraulic control type, Pilot pressure port X and leakage port Y, page 160](#)

3.3.4 Electrical and hydraulic zero positions



The hydraulic zero position of the spool is not necessarily identical to the electrical zero position.

The electrical zero position of the spool is set if the command signal input for the spool position is equal to zero.

The hydraulic zero position is the position of the spool in which the pressures, when the spool is symmetrical, are equal in the two sealed control ports.

The hydraulic zero position is model-dependent.

Electrical and hydraulic zero positions of the spool

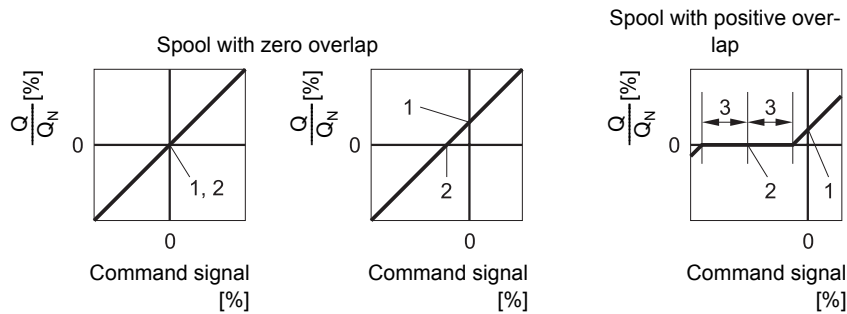

Item	Designation
1	Electrical zero position of the spool
2	Hydraulic zero position of the spool
3	Spool overlap

Fig. 5: Examples of the electrical and hydraulic zero positions of different spools in the flow signal characteristic curve

3.4 Control

Valves without field bus interfaces must be commanded with an analog signal(s) via connector X1.

Valves with field bus interfaces can be controlled either with analog command signals via connector X1 or with digital signals via the field bus interface (connectors X3 and X4).

⇒ Chap. "3.1.5 Signal interfaces", page 22

⇒ Chap. "3.4.1 Signal types for set-point and actual value", page 40

Activation of the Valve Command

DANGER



Danger!

Danger due to electric shock.

- ▶ Only use SELV/PELV power supplies to supply the valve.

3.4.1 Signal types for set-point and actual value

Valves without field bus interfaces must be commanded with an analog signal(s) via connector X1.

Depending on the variant, various signal types can be configured for the analog flow function input signal (input) and for the analog spool position signal (actual value output) applied to the X1 connector..

⇒ [Tab. 6, page 41](#)

The signal type can be set via the service or fieldbus interface in the valve software. Setting and interrogation can be performed for example with the Moog Valve and Pump Configuration Software.

⇒ [Chap. "3.6 Moog Valve and Pump Configuration Software", page 48](#)

Signal types for command signal	Benefits
±10 V	Simple measurement of the signal, e.g. with an oscilloscope
±10 mA	In contrast to the 4–20 mA signal type, less power is required with low command signals;
4 to 20 mA	Detection of fault in the electrical line and large transmission lengths are possible

Tab. 5: Benefits of the different signal types for analog command inputs

Signal types for analog set-point value input and actual value output

Benefits of the different signal types for analog command inputs



It is necessary when ordering the valve to establish which signal type for the analog command inputs is to be set in the valve on delivery.

Which signal type has been set in the valve on delivery can be ascertained from the signal type identification, i.e. the 10th position in the type designation.

⇒ [Chap. "11.1 Nameplates", Digit 10, Command signal for 100 % spool stroke, page 161](#)

Which signal type is currently set can be ascertained for example with the Moog Valve and Pump Configuration Software.



All current and voltage inputs are floating but can be connected to ground (single-ended) by means of external wiring.

Basically, activation of the command inputs with differential signals is to be preferred. If the command signal cannot be transmitted differentially, the reference point of the command input at the valve must be connected to ground (GND).

⇒ [Chap. "7.14.1 Single-ended command signals", page 103](#)

Because current inputs have a lower input resistance than voltage inputs and are therefore less prone to interference, a current signal is preferable to a voltage signal.

Pin assignment of connector X1:

⇒ [Chap. "7.4.1 Pin assignment of connector X1", page 69](#)

Configuration: ⇒ [Chap. "8.3 Configuration of the valves", page 128](#)

3.4.1.1 Signal type identification

The signal type identification, i.e. the 10th position in the valve type designation, indicates which signal type for the command inputs is set in the valve when it is delivered.

Signal type identification

The signal type of the command signal input applies in combination with the signal type of the spool position signal (actual value output).

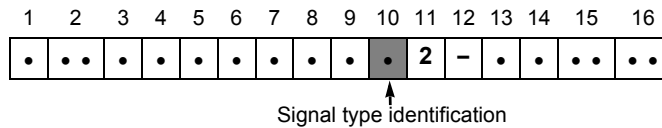

Version	Command signals for 100 % spool stroke	
	Command signal (X1, input contacts 1 and 2)	Stroke position signal (X1, output contacts 4 and 7)
D	±10 V	2–10 V
E	4–20 mA	4–20 mA
M	±10 V	4–20 mA
X	±10 mA	4–20 mA
9	Fieldbus	Fieldbus
Y	Others on request.	

Tab. 6: Signal types command value and spool position signal in the type designation

The analog command signal I_{in} or U_{in} is the flow command value input. The stroke position signal (actual output value) I_{out} or U_{out} is proportional to the mechanical position of the spool.

⇒ [Chap. "7 Electrical connection", page 61](#)



The type designation and the signal type indicate the valve's delivery status.

By changing the valve configuration, it is possible to change the valve in such a way that it no longer conforms to this status.

Which signal type is currently set can be ascertained for example with the Moog Valve and Pump Configuration Software.

Type designation:

⇒ [Chap. "11.1 Nameplates", Digit 10, Command signal for 100 % spool stroke, page 161](#)

3.4.1.2 Flow control command inputs

Signal type for the command input: ± 10 mA

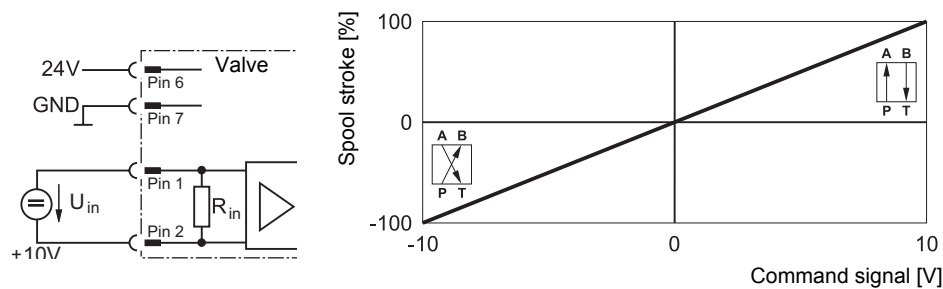

Floating flow control command input ± 10 V

Fig. 6: Floating flow control command input ± 10 V (circuit and characteristic curve)

The spool stroke is proportional to the input voltage U_{in} .

- $U_{in} = 10$ V 100 % spool stroke, valve opening: P→A and B→T
- $U_{in} = 0$ V Spool in electrical zero position
- $U_{in} = -10$ V 100 % spool stroke, valve opening: P→B and A→T

CAUTION



Danger of personal injury and damage to property!

The potential difference of each input to GND must be between -15 V and 32 V.

- ▶ Only use SELV/PELV power supplies.
- ▶ Heed the correct dimensioning of the cables.

If there is no differential command input source available, the reference point of the command inputs must be connected to 0 V of the command input source (GND).

The operating direction of the command signal can be altered by modifying the parameters of the valve software.

Signal type for the command input: ± 10 V

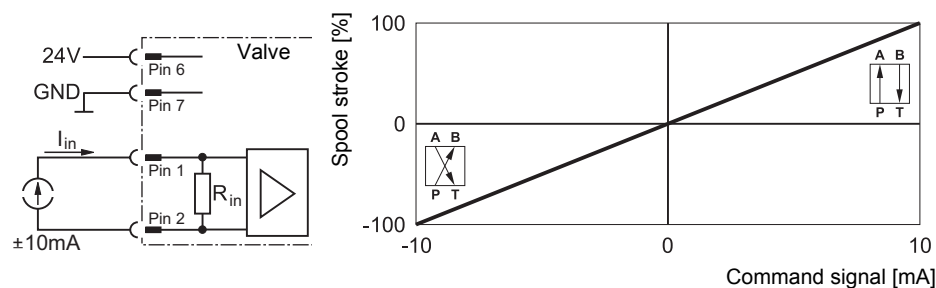

Floating flow control command input ± 10 mA

Fig. 7: Floating flow control command input ± 10 mA (circuit and characteristic curve)

The spool stroke is proportional to the input current I_{in} .

- $I_{in} = 10$ mA 100 % spool stroke, valve opening: P→A and B→T
- $I_{in} = 0$ mA Spool in electrical zero position
- $I_{in} = -10$ mA 100 % spool stroke, valve opening: P→B and A→T

CAUTION**Risk of valve electronic damage!**

The input current I_{in} of the command inputs with current input signal must be between -25 mA and 25 mA!

Voltage levels in excess of 5 V may cause the destruction of the integrated valve electronics.

- ▶ Only use SELV/PELV power supplies.
- ▶ Heed the correct dimensioning of the cables.

CAUTION**Danger of personal injury and damage to property!**

The potential difference of each input to GND must be between -15 V and 32 V.

- ▶ Only use SELV/PELV power supplies.
- ▶ Heed the correct dimensioning of the cables.

If there is no floating command input source available, the reference point of the command inputs must be connected to 0 V of the command input source (GND).

The operating direction of the command signal can be altered by modifying the parameters of the valve software.

Signal type for the command input: 4–20 mA**Floating flow control
command input 4–20 mA**

Fig. 8: Floating flow control command input 4–20 mA (circuit and characteristic curve)

The spool stroke is proportional to the input current I_{in} .

- $I_{in} = 20 \text{ mA}$ 100 % spool stroke, valve opening: P→A and B→T
- $I_{in} = 12 \text{ mA}$ Spool in electrical zero position
- $I_{in} = 4 \text{ mA}$ 100 % spool stroke, valve opening: P→B and A→T

CAUTION**Risk of valve electronic damage!**

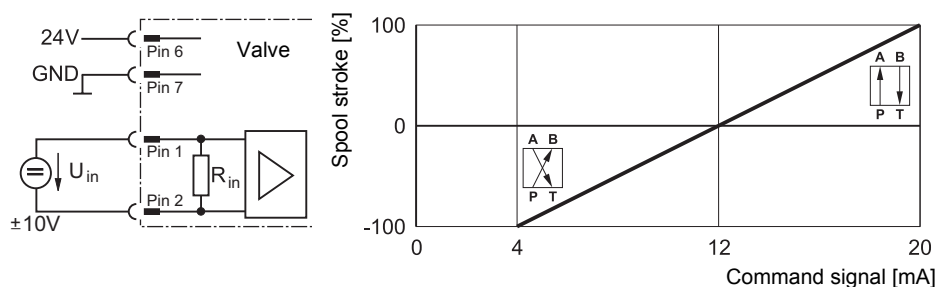
The input current I_{in} of the command inputs with current input signal must be between -25 mA and 25 mA!
Voltage levels in excess of 5 V may cause the destruction of the integrated valve electronics.

- ▶ Only use SELV/PELV power supplies.
- ▶ Heed the correct dimensioning of the cables.

CAUTION**Danger of personal injury and damage to property!**

I_{in} the signal range 4–20 mA command signals $I_{in} < 3 \text{ mA}$ (e.g. due to a faulty electric cable) indicate a fault.

- ▶ The valve response to this fault can be set and activated via the service or fieldbus interface in the valve software. Setting and activation can be performed for example with the Moog Valve and Pump Configuration Software.
- ▶ Examine the connection cables for defects.

CAUTION**Danger of personal injury and damage to property!**

The potential difference of each input to GND must be between -15 V and 32 V.

- ▶ Only use SELV/PELV power supplies.
- ▶ Heed the correct dimensioning of the cables.

If there is no floating command input source available, the reference point of the command inputs must be connected to 0 V of the command input source (GND).

The operating direction of the command signal can be altered by modifying the parameters of the valve software.

3.4.2 Analog actual value output

The valves have an analog actual value output:

The stroke position signal I_{out} or U_{out} (X1, contact 4) specifies the measured actual value of the position of the spool in the flow function.

The reference point for the analog output is GND (X1, contact 7).

The entire spool stroke corresponds to 4 to 20 mA or 2 to 10 V.

$I_{out} = 20 \text{ mA}$	$U_{out} = 10 \text{ V}$	100 % spool stroke, valve opening: P→A and B→T
$I_{out} = 12 \text{ mA}$	$U_{out} = 6 \text{ V}$	Spool in electrical zero position
$I_{out} = 4 \text{ mA}$	$U_{out} = 2 \text{ V}$	100 % spool stroke, valve opening: P→B and A→T

Analog actual value output

**Stroke position signal (X1, contacts 4 and 7)
4–20 mA or 2–10 V**



External detection of electrical cable faults can be realized with the 4–20 mA and 2–10 V analog spool position signal.

$I_{out} = 0 \text{ mA}$ or $U_{out} = 0 \text{ V}$ suggests a cable break.



The actual value output 4–20 mA and 2–10 V is short-circuit-proof.

Signal types command signal and spool position signal in the type designation:

⇒ [Tab. 6, page 41](#)

Pin assignment of connector X1:

⇒ [Chap. "7.4.1 Pin assignment of connector X1", page 69](#)

Conversion of actual value output signals I_{out} from 4–20 mA into 2–10 V:

⇒ [Chap. "7.14.2 Conversion of actual value output signals \$I_{out}\$ ", page 104](#)

The 4–20 mA output can be transformed using this switch to 2–10 V or the valve can be ordered directly with a 2–10 V output.

3.4.3 Digital enable input

The valves have a digital enable input.

Enable input

Switching of the valve to standby or fail-safe state can also be triggered by corresponding signals at the enable input of connector X1:

- Signals between 8.5 V and 32 V based on GND at the enable input switch the valve to standby.
- Signals lower than 6.5 V at the enable input switch the valve to fail-safe state.

Pin assignment of connector X1:

⇒ [Chap. "7.4.1 Pin assignment of connector X1", page 69](#)

Fail-safe state of the valves:

⇒ [Chap. "3.2 Safety function/fail-safe", page 25](#)

3.5 Configuration software

By changing the configuration of the software in the valve, the functionality of the valve can be influenced using the external configuration software.

Configuration software

⇒ Chap. "8.3 Configuration of the valves", page 128

CAUTION



Risk of personal injuries!

In case of malfunctions of the valve due to incorrectly-configured software, there is a danger due to uncontrolled movements of the higher-level machine and destruction in the area around the higher-level machine.

- ▶ When changing the configuration of the valve, make sure that the functionality of the valve matches that described in the operating instructions and the planned functionality.

The valve software is an integral part of the valve and cannot be altered, copied or replaced by the user.

Many of the functions made available by the valve software can be configured by the user by modifying parameters. For this purpose, the desired parameters must be transferred to the valve via the service or fieldbus interface. Parameters can basically be modified by each fieldbus node, for example also by the machine controller.

Configuration of the valves



If the valve is incorporated in a fieldbus, the parameters can be transferred to the valve each time the system is powered up. This ensures that the valve always receives the correct configuration of the valve software.

The Moog Valve and Pump Configuration Software is available as an accessory to simplify start-up, diagnosis and configuration of the valves.

⇒ Chap. "3.6 Moog Valve and Pump Configuration Software", page 48

3.6 Moog Valve and Pump Configuration Software

The *Moog Valve and Pump Configuration Software* is a Microsoft® Windows® application enabling fast and convenient start-up, diagnosis and configuration of the valves.

The Moog Valve and Pump Configuration Software communicates with the valves via the service or CAN bus interface. A PC with a suitable interface card is required for this purposes.

The Moog Valve and Pump Configuration Software offers the following functions:

- Transfer of data between PC and valves
- Storage of the current valve settings on the PC
- Activation of the valves with graphic software control elements
- Graphic representation of status information, command signals and actual values as well as characteristic curves for the valves
- Recording and visualization of the system parameters with the integrated data logger and the integrated oscilloscope function



The Moog Valve and Pump Configuration Software is available as an accessory.

⇒ [Chap. "12.1 Accessories for valves in the D67XK series", page 222](#)

3.7 Nameplate

See "Technical data":

⇒ [Chap. "11.1 Nameplates", page 154](#)

⇒ [Chap. "11.1.1 Model number and type designation", page 156](#)

⇒ [Chap. "11.1.2 LSS address", page 163](#)

⇒ [Chap. "11.1.3 Data matrix code", page 163](#)

Moog Valve and Pump Configuration Software

4 Characteristic curves

All characteristic curves are type-specific.

Flow rate characteristic curves, step response and frequency response characteristic curves:

⇒ Chap. "11 Technical Data", page 152

4.1 Flow diagram (4-way operation)

Flow diagram (4-way operation)

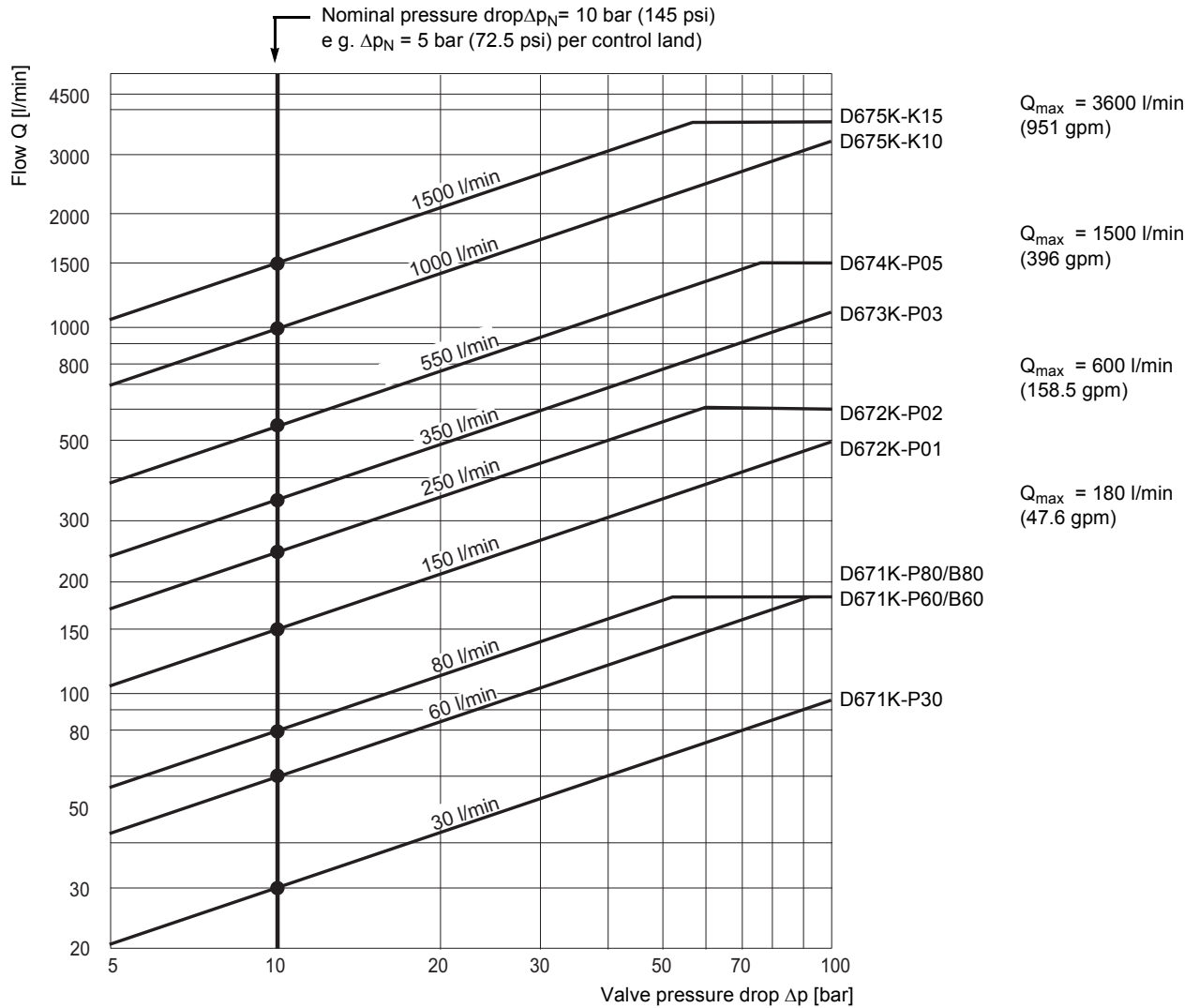

Fig. 9: Flow diagram (4-way operation) D671K to D675K

The flow rate to be set depends not only on the position of the spool, but also on the pressure difference Δp at the individual control lands.

A flow control command signal of 100 % produces with a rated pressure difference of $\Delta p_N = 5 \text{ bar}$ (72.5 psi) per control land the rated flow- Q_N . If the pressure difference is altered, so the flow Q also changes with a constant command signal in accordance with the following formula:

Formula for calculating the flow Q

$$Q = Q_N \cdot \sqrt{\frac{\Delta p}{\Delta p_N}}$$

Q [l/min] : actual flow

Q_N [l/min] : rated flow

Δp [bar][psi] : Actual pressure difference per control land

Δp_N [bar][psi] : Rated pressure difference $\Delta p_N = 5 \text{ bar}$ (72.5 psi) per control land



To avoid cavitation, the flow speed of the actual flow Q calculated in this way at ports (P, A, B, X, Y and T) must not be too great.

The actual flow Q calculated thus must not exceed a mean flow velocity of 30 m/s (96.54 ft/s) at ports P, A, B, X, Y and T.

4.2 Flow signal characteristic curve

The flow-signal characteristic curves are type-specific.

⇒ Chap. "11 Technical Data", page 152

As an example, a linear characteristic curve of a D671K (cf. Fig. 12, P30) is depicted here.

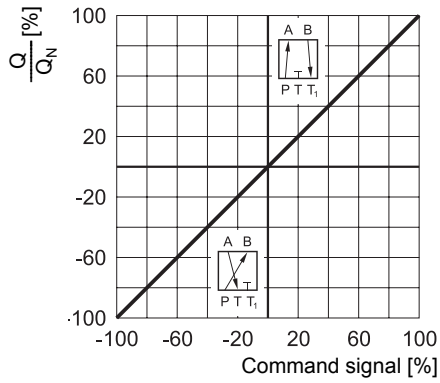

Fig. 10: Flow signal characteristic curve with equal electrical and hydraulic zero positions

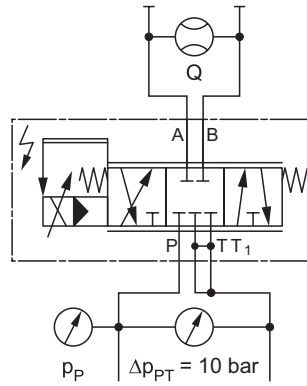

Fig. 11: Design for measuring the flow signal characteristic curve

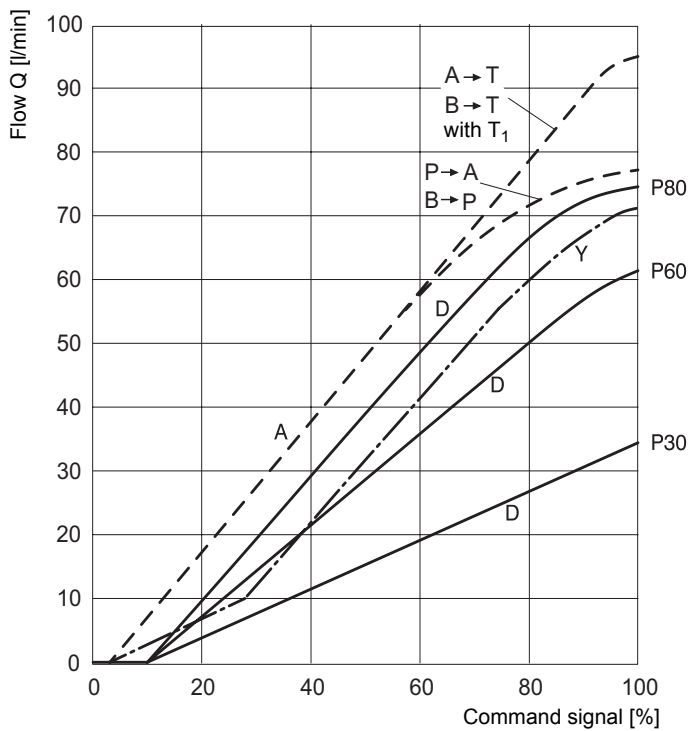

Fig. 12: Valve D671K, flow-signal characteristic curve

Flow signal characteristic curve D671K

5 Transportation and Storage

Safety instructions: Transportation and Storage

WARNING



Danger of property damage!

In order to ensure perfect, reliable, and safe operation of the valves, heed the following:

- ▶ The valves must be protected in particular to prevent entry of dust and moisture.
- ▶ The permissible ambient conditions for the valves must be maintained at all times also in the case of transportation and storage.
- ▶ ⇒ [Chap. "11 Technical Data", page 152.](#)

WARNING



Danger of explosion!

During transport and storage, cables on the valve, cable glands, screw plugs, and plug connectors must not be damaged.

- ▶ The valve must not be started up with damaged cables, plug connectors, and screw plugs, and it must be sent to us or to one of our authorized service centers immediately.

CAUTION

Risk of injury!

To provide protection against injuries or other damaging influences on health, suitable protective measures must be taken if necessary prior to and when carrying out any work on the valves or the machine, such as mounting or removing, electrical or hydraulic connection, troubleshooting or servicing, and when handling the valves, accessories, tools or hydraulic fluids.

- ▶ ⇒ [Chap. "2.2 Occupational safety and health", page 15](#)

CAUTION

Risk of damage due to dirt and moisture!

This is the only way of adequately protecting the valves against the penetration of dirt and moisture and protecting the gaskets/seals against the effects of ozone and UV.

- ▶ The valves must not be transported or stored without their shipping plate fitted.
- ▶ The valve shipping plate may only be removed from the valve hydraulic ports directly prior to mounting and must be reinstalled directly after the valve has been removed.
- ▶ The shipping plate and the associated attachment elements (screws and nuts) must be kept for later use, e.g. during transportation.

CAUTION

Risk of damage due to condensation!

Due to temperature fluctuations during transport and storage of the valves, humidity may condense.

- ▶ Wait with the start-up of the valves until the valves have reached the ambient temperature
-

CAUTION

Risk of damage!

The plugs, connectors, and connection cables of the valves may not be used for other purposes, such as for stepping on or as transport holders.

CAUTION

Danger of personal injury and damage to property!

Warranty and liability claims for personal injury and damage to property are excluded if they are caused by valves, spare parts or accessories having been stored or transported outside their original packaging.

- ▶ Store and transport valves, spare parts, and accessories only in properly-sealed original packaging.
 - ▶ ⇒ [Chap. "1.8 Warranty and liability", page 11.](#)
-

CAUTION

Risk of damage!

Improper handling during transport or storage of the valves, spare parts, and accessories can cause damage to the original packaging and to the contents.

- ▶ After transporting or storing valves, spare parts and accessories, check the original packaging and contents for possible damage.
 - ▶ Do not start up the system if the packaging or contents show signs of damage. In this case, notify us or the supplier responsible immediately.
 - ▶ In the event of transportation damage, store the damaged packaging so that if necessary damages can be claimed from the transport contractor.
-

5.1 Checking/unpacking a delivery

Procedure:

1. Check whether the packaging is damaged.
2. Remove packaging.
3. Keep damaged packaging so that damage claims can be lodged against the transport company.
We recommend that you keep the original packaging for later transportation or storage operations.
4. Dispose of packaging material that is no longer needed according to the local specific disposal regulations and environmental protection provisions.
5. Check whether the contents of the packaging are damaged.
6. In case of damaged packaging or damaged content, inform us and the responsible supplier immediately.
7. Check whether the delivery matches the order and the delivery note.
8. In case of incorrect or incomplete delivery, inform us or the responsible supplier immediately.

Procedure for checking/ unpacking a delivery

5.2 Scope of delivery of the valve

The scope of delivery of the valve consists of:

- Valve with mounted oil-proof shipping plate at the hydraulic port
- For D671K:
 - 6 O-rings ID 12.4 x dia. 1.8 [mm] (0.49 x 0.07 in) (0.61 x 0.07 in) for ports A, B, P, T1 and X
 - 1 O-ring ID 15.6 x dia. 1.8 [mm] (0.61 x 0.07 in) (0.30 x 0.07 in) for port Y
- For D672K:
 - 4 O-rings ID 21.89 x dia. 2.6 [mm] (0.61 x 0.07 in) (0.61 x 0.07 in) for ports A, B, P and T
 - 2 O-rings ID 10.82 x dia. 1.8 [mm] (0.61 x 0.07 in) (0.61 x 0.07 in) for ports X and Y
- For D673K and D674K:
 - 4 O-rings ID 34.60 x dia. 2.6 [mm] (0.61 x 0.07 in) (0.61 x 0.07 in) for ports A, B, P and T
 - 2 O-rings ID 20.92 x dia. 2.6 [mm] (0.61 x 0.07 in) (0.61 x 0.07 in) for ports X and Y
- For D675K:
 - 4 O-rings ID 53.60 x dia. 3.5 [mm] (0.61 x 0.07 in) (0.61 x 0.07 in) for ports A, B, P and T
 - 2 O-rings ID 14.00 x dia. 1.8 [mm] (0.61 x 0.07 in) (0.61 x 0.07 in) for ports X and Y
- User manual D67XK series

Scope of delivery of the valve

5.3 Storage

The following effects may occur in the course of long-term storage:

- Gasket/seal materials become brittle, possibly resulting in leaks
- Hydraulic fluid becomes gummy, possibly resulting in friction.

Effects of long-term Storage

In order to avoid possible resulting impairments or damage, we recommend that the valve, after a period of storage or operation of more than 5 years, be inspected by us or one of our authorized service centers.

6 Mounting and Connection to the Hydraulic System

DANGER



Danger of injury due to electric voltage and unexpected movements!

Work on machines that are not shut down presents a danger to life and limb. Work such as mounting or removal, electrical or hydraulic connection, troubleshooting or service may only be performed on machines and valves that are shut down.

- ▶ Make sure to shut the machine down and switch it off.
- ▶ Make sure that the drive motor cannot be switched on.
- ▶ For this purpose, switch off the supply voltage as well as that of connected peripherals, such as externally powered transducers or programming units.
- ▶ Make sure that all power-transmitting components and connections (electrical and hydraulic) are switched off according to the manufacturer's instructions and secured against switching on again. If possible, remove the main fuse from the machine.
- ▶ Make sure that the machine is completely depressurized.

**Safety instructions:
Mounting and Connection
to the Hydraulic System**

DANGER



Danger of poisoning and injury due to hydraulic fluid squirting out under pressure!

Contact with hydraulic fluids can damage your health (e.g. eye injuries, skin and tissue damage, poisoning in case of inhaling).

- ▶ Wear protective gloves and safety glasses.
- ▶ If hydraulic fluid gets into your eyes or on your skin, consult a doctor immediately.
- ▶ When handling hydraulic fluids, observe the safety provisions applicable to the hydraulic fluid used.

WARNING



Danger of explosion!

For mounting and connection to the hydraulic system, cables on the valve, cable glands, screw plugs, and plug connectors may not be damaged.

- ▶ The valve must not be started up with damaged cables, plug connectors, and screw plugs, and it must be sent to us or to one of our authorized service centers immediately.

CAUTION

Risk of injury!

To provide protection against injuries or other damaging influences on health, suitable protective measures must be taken if necessary prior to and when carrying out any work on the valves or the machine, such as mounting or removing, electrical or hydraulic connection, troubleshooting or servicing, and when handling the valves, accessories, tools or hydraulic fluids.

- ▶ ⇒ [Chap. "2.2 Occupational safety and health", page 15](#)

CAUTION**Danger of personal injury and damage to property!**

Working with and on the valves without the required basic mechanical, hydraulic, and electrical knowledge may cause injuries or parts may be damaged.

- ▶ Only properly qualified and authorized users may work with and on the valves.
- ▶ ⇒ [Chap. "1.4 Selection and qualification of personnel", page 7](#)

6.1 Dimensions (installation drawings)

The dimensions of the valves depend on the series

⇒ [Chap. "11 Technical Data", page 152](#)

6.2 Mounting surface

6.2.1 Surface quality

Evenness as per [EN ISO 1302](#):

< 0.01 mm (400 µin)
over 100 mm (3.94 in)

**Evenness and roughness
of the mounting
surface**

Average roughness R_a according to
[EN ISO 1302](#):

< 0.8 µm (30 µin)

6.2.2 Holes in mounting surface

The details for the mounting surface depend on the series.

Holes in the mounting surfaces:

⇒ [Chap. "11 Technical Data", page 152](#)

6.3 Mounting the valve

6.3.1 Tools and materials required

The following tools and materials are required for mounting the valves:

- For removing the shipping plate
Wrench for hexagon socket head cap screws or regular screwdriver (only valve D671K) and if necessary wrench
- For mounting the valve
Torque wrench for hexagon socket head cap screws
- Installation screws
- Replacement for O-rings of ports to be replaced if necessary.

Tools and materials required for mounting the valves



The installation screws and the O-rings to be replaced if necessary are not included in the scope of delivery for the valves. They are available as an accessory.

⇒ [Chap. "12 Accessories, Spare Parts, and Tools", page 222](#)

The wrench sizes of the hexagon socket cap head screws for mounting are series-specific.

Details about the screws and their tightening torque:

⇒ [Tab. 7, page 58](#)

Installation screws



The installation screws for the transport plates are type-specific. Details about attachment screws and their tightening torque:

⇒ [Chap. "12 Accessories, Spare Parts, and Tools", page 222](#)

Attachment screws

6.3.2 Specification for installation screws for the valves

	Hexagon socket head cap screws as per EN ISO 4762 Quality class 10,9	Number required	Width across flats/ Tightening torque
D639K NG10	M6x40	4	WAF 5 11 Nm (8 lbf ft) ± 10 %
D639K NG16	M6x55	2	WAF 5 11 Nm (8 lbf ft) ± 10 %
	M10x60	4	WAF 8 54 Nm (40 lbf ft) ± 10 %
D637K/D639K NG25	M12x75	6	WAF 10 94 Nm (69 lbf ft) ± 10 %
D639K NG32	M20x90	6	WAF 17 460 Nm (339 lbf ft) ± 10 %

Specification for installation screws for the valves

Tab. 7: Specification for installation screws for the valves

6.3.3 Procedure

CAUTION

**Danger of personal injury and damage to property!**

The shipping plate attachment screws must not under any circumstances be used to mount the valve.

- ▶ Use only the installation screws specified here for mounting the valve.
- ▶ The fastening of the valve with unsuitable screws can be destroyed under pressure.

**Safety instructions:
Mounting the valve**

CAUTION

Risk of damage due to dirt and moisture!

This is the only way of adequately protecting the valves against the penetration of dirt and moisture and protecting the gaskets/seals against the effects of ozone and UV.

- ▶ The valves must not be transported or stored without their shipping plate fitted.
- ▶ The valve shipping plate may only be removed from the valve hydraulic ports directly prior to mounting and must be reinstalled directly after the valve has been removed.
- ▶ The shipping plate and the associated attachment elements (screws and nuts) must be kept for later use, e.g. during transportation.

CAUTION

Danger of explosion and risk of damage due to overheating!

In order to prevent overheating of the valves.

- ▶ Mount the valves so that good ventilation is ensured.
- ▶ The maximum permissible temperatures of the respective temperature classes and the maximum permissible ambient temperature as well as the maximum permissible temperature of the hydraulic fluid may not be exceeded.
- ▶ ⇒ [Chap. "1.3 Intended operation", page 5](#)

CAUTION

Risk of damage!

Vibrations and shocks can damage the valve.

- ▶ Do not mount the valve directly on machine parts that are exposed to strong vibrations or sudden movement.
- ▶ On units that are moved in jerks and jolts, the movement direction of the spool should not be the same as the movement direction of the unit. ⇒ [Chap. "11 Technical Data", page 152](#)

CAUTION**Increased wear and functional faults!**

The cleanliness of the connection and mounting surface influences the cleanliness and the life cycle of the valve. Soiling causes wear and functional faults.

- ▶ Make sure the valve is extremely clean.
- ▶ Install the valve dirt-free.
- ▶ Make sure that connections and attachments are clean.
- ▶ Do not use steel wool or cloths with lint for cleaning.
- ▶ Do not use any cleaning agents or methods that could attack the surfaces or the O-rings mechanically or chemically.

Procedure for mounting the valve:

1. Clean the valve mounting and connecting surfaces.
Check and if necessary correct the evenness and roughness of the mounting surface.
⇒ [Chap. "6.2.1 Surface quality", page 57](#)
2. Remove the shipping plate from the valve's hydraulic port.
The shipping plate and the associated fastening elements (screws and nuts) must be kept for later use, e.g. during transportation.
3. Check that O-rings in the valve ports (P, A, B, X, Y and T) are present and for elasticity, integrity and correct seating.
If necessary, install O-rings, replace or correct the seating.
4. Paying attention to the mounting pattern, place the valve on the mounting surface and align with the mounting bores.
5. Secure the valve. To do so, tighten the installation screws (hexagon socket head cap screws) free from distortion in diagonal sequence.
Tightening torque::
⇒ [Tab. 7, page 58](#)



Due to the great weight of the D675K valve, special measures must be taken during mounting and removal.
There are two eye bolts screwed into the D675K valve for lifting and transport.
Threaded holes are provided in the D673K and D674K valves, into which the eye bolts for lifting and transport can be screwed.

Procedure for mounting the valve

7 Electrical connection

7.1 Safety instructions for installation and maintenance

DANGER

**Danger of explosion!**

An explosion can be triggered by sparks when switching on the machine.

- ▶ Open connectors for the interface must absolutely be covered before start-up.
- ▶ The eXLink connectors from CEAG must be mounted according to the instructions in the operating instructions for the eXLink connectors.
- ▶ In the standard model with a screw plug, the service connector X10 is not permitted for use in hazardous areas.
- ▶ The service connector X10 in the standard model M8, 3-pin must be sealed with the original screw plug belonging to the valve before start-up.
- ▶ When mounting the screw plug for the service connector X10, it must be observed that the gasket and the thread of the screw plug as well as the thread in the electronic housing of the valve are not damaged.
- ▶ In case of damage to the screw plug for the service connector X10 or the threads in the electronic housing, the valve must not be operated.
- ▶ Tightening torque for screw plug:
⇒ [Chap. "3.1.2 Representative depiction of the valve", page 18](#)

WARNING

**Danger of explosion!**

For the electrical connection of the valve, cables, cable glands, screw plugs, and connectors must not be damaged.

- ▶ The valve must not be started up with damaged cables, connectors, and screw plugs, and it must be sent to us or to one of our authorized service centers immediately.

WARNING

**Danger of explosion!**

To guarantee safe operation in hazardous areas:

- ▶ The signal interfaces of the valve are implemented with explosion-proof connectors.
- ▶ For mounting and removal of the connectors as well as operation of the valve, the notes and instructions in the "Explosion-proof connectors eXLink, CEAG" operating instructions must absolutely be adhered to.

CAUTION**Danger of personal injury and damage to property from interchanged connections!**

Interchanging connections causes unforeseeable movements of the machine and thus corresponding risks to people and equipment.

- ▶ When starting up valves on the fieldbus for the first time, we recommend that the component be operated in a depressurized state.
- ▶ Before connecting valves to the fieldbus, it is essential to complete the electrical and if necessary hydraulic connection of the component properly as described in the user manual.

CAUTION**Danger of personal and property damage due to defective accessories and defective spare parts!**

Unsuitable or defective accessories or unsuitable or defective spare parts may cause damage, malfunctions or failure of the valve or the machine.

- ▶ Use only original accessories and original spare parts.

CAUTION**Danger of personal injury and damage to property!**

Improperly laid connection cables can cause damage, malfunctions or failure of valves or the machine.

- ▶ Do not lay valve connection cables in the immediate vicinity of high-voltage cables or together with cables that switch inductive or capacitive loads.

CAUTION**Danger of personal injury and damage to property!**

For the floating analog inputs of connector X1, the potential difference (referenced to supply zero) must be between -15 V and 32 V.

- ▶ Only use SELV/PELV power supplies.
- ▶ Heed the correct dimensioning of the cables.

CAUTION**Danger of personal injury and damage to property!**

In the signal range 4–20 mA input currents < 3 mA can cause faulty reactions with digital valves.

- ▶ Examine the connection cables for defects.

CAUTION**Risk of valve electronic damage!**

In the signal range 4–20 mA command signals $I_{in} < 3 \text{ mA}$ (e.g. due to a faulty electric cable) indicate a fault.

- ▶ The valve response to this fault can be set and activated via the service or fieldbus interface in the valve software. Setting and activation can, for example, take place with the Moog Valve and Pump Configuration Software.
- ▶ Examine the connection cables for defects.

CAUTION**Risk of valve electronic damage!**

The input current must be between -25 mA and 25 mA. Input currents outside this permissible range will destroy the input.

- ▶ Only use SELV/PELV power supplies.
- ▶ Heed the correct dimensioning of the cables.



The valves described here must only be operated with external fuse protection. The information about the external fuse protection of the valves is included in Chapter 11.3 to 11.7.

- ⇒ [Tab. 36, page 166](#)
- ⇒ [Tab. 37, page 177](#)
- ⇒ [Tab. 38, page 188](#)
- ⇒ [Tab. 39, page 199](#)
- ⇒ [Tab. 40, page 210](#)

7.1.1 Protective grounding and electrical shielding**DANGER****Danger of explosion in case of unsafe operation!**

In order to create as small a potential difference in the machine as possible and guarantee safe operation of the machine, the equipotential bonding and protective conducting system for a machine in which the valves should be used must be constructed according to EN 60204-1.

- ▶ Connect all elements of the machine to each other via equipotential bonding conductors.
- ▶ Connect all elements of the machine that have exposed metal surfaces via protective conductors to the protective conductor rail.
- ▶ Connect all the protective conductors and the equipotential bonding conductor in the main cabinet via the protective conductor rail to the protective earth (PE) terminal.

**Equipotential bonding /
protective conductor
system**

DANGER**Danger to life!**

This protective conductor is not a replacement for the normal equipotential bonding system.

- ▶ Connect all elements of the machine system with exposed metallic surfaces to the protective grounding rail.

DANGER**Danger to life due to electric shock!**

Very strong current can flow via the shield connection of the valve.

- ▶ Extreme caution is required since for some industrial applications, no good equipotential bonding can be implemented.
- ▶ An effective equipotential bonding system must be set up in compliance with DIN EN 60204-1, Section 8.

DANGER**Danger to life!**

People can be injured and property damaged through the operation of the valve with an unsafe power supply.

- ▶ Only use SELV/PELV power supplies as per EN 60204-1!

7.1.2 Moog Valve and Pump Configuration Software

CAUTION

**Danger of personal injury and damage to property!**

Improper handling of the Moog Valve and Pump Configuration Software causes malfunctions and thus corresponding risks to people and equipment.

- ▶ For safety reasons, the Moog Valve and Pump Configuration Software must not be used inside a machine for visualization purposes or as an operator terminal.

CAUTION

**Danger of personal injury and damage to property!**

It is not permitted to operate the Moog Valve and Pump Configuration Software on a fieldbus while the machine is running.

It is only permitted to activate valves via the Moog Valve and Pump Configuration Software if this does not cause any dangerous states in the machine and in its surroundings.

CAUTION

**Danger of personal injury and damage to property!**

Activating valves via the Moog Valve and Pump Configuration Software within a network can give rise to unforeseeable events if fieldbus communication takes place simultaneously between the machine control or other bus nodes!

- ▶ Deactivate the fieldbus communication for machine control and other bus nodes.

CAUTION

**Danger of personal injury and damage to property!**

Messages from the Moog Valve and Pump Configuration Software can also be received by other bus nodes. This may trigger unforeseeable events.

- ▶ Deactivate the fieldbus communication for machine control and other bus nodes.

CAUTION

**Danger of personal injury and damage to property!**

If danger-free operation of the valves via the Moog Valve and Pump Configuration Software can also not be ensured with deactivated fieldbus communication to the machine control and other bus nodes, the following must be heeded:

- ▶ The valves may only communicate depressurized and in a direct connection (point-to-point) with the Moog Valve and Pump Configuration Software.

CAUTION**Data loss!**

Data communication between the valve electronics and the Moog Valve and Pump Configuration Software may be disrupted if other fieldbus nodes (e.g. a controller) are accessing the valve electronics at the same time.

- ▶ Deactivate the fieldbus communication for machine control.

7.2 Block diagram

Fig. 13: Block diagram of the valve electronics

* Depending on the model, the valves can have different electrical connections.

7.3 Arrangement of connectors

The depiction of the electronics housing is exemplary for all sizes.

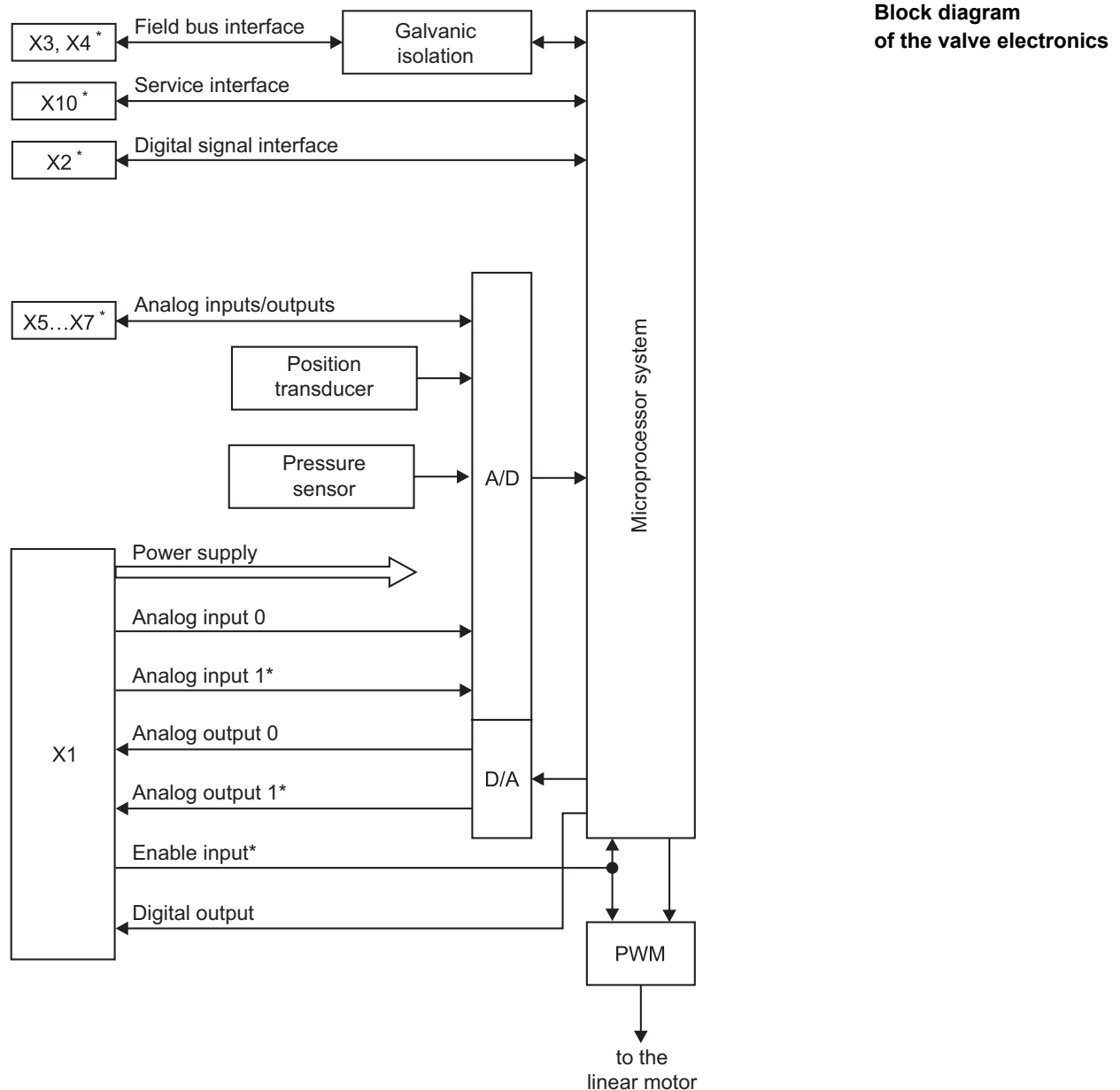
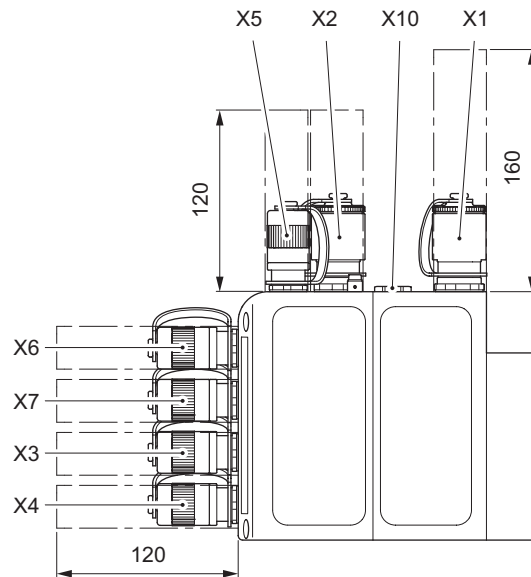

Arrangement of connectors on the valve electronics housing (maximum equipment specification)

Fig. 14: Arrangement of connectors on the valve electronics housing (maximum equipment specification)

X1	Connectors, analog signals and supply voltage ⇒ Chap. "7.4 Connector X1", page 69
X2	Connector, optional digital signal interface ⇒ Chap. "7.7 Digital signal interface", page 75
X3 X4	The fieldbus connectors X3 and X4 are only provided on valves with fieldbus interfaces. ⇒ Chap. "7.8 Fieldbus connectors X3 and X4", page 77
X5 X6 X7	Connectors, analog signals ⇒ Chap. "7.9 Analog input connectors X5, X6 and X7", page 83
X10	The X10 service connector is only present for valves without CAN bus interface. By default, the X10 service connector is not approved for use in hazardous areas, however on request it is available for use in hazardous areas. ⇒ Chap. "7.10 Service connector X10", page 86

Allocation of interfaces to connectors

The valve electronics are equipped with connectors that are designated X1 through X10.

The table below shows which interfaces are accommodated in the different connectors.

Interface type	Interface	Connector
Analog input	Analog input 0	X1
	Analog input 2	X5
	Analog input 3	X6
	Analog input 4	X7
Analog output	Analog output 0	X1
Digital input	Digital input 0	X1
Digital output	Digital output 0	X1
Digital signal interface	SSI transducer	X2
Fieldbus interface	CANopen, Profibus-DP, EtherCAT	X3, X4
Service interface		X10

Tab. 8: Allocation of interfaces to connectors



The availability of the interface depends on the model.

Allocation of interfaces to connectors

7.4 Connector X1

Service connector X1 is designed in accordance with [DIN EN 175201-804](#) and is available in the following versions:

- 7-pin connector with protective conductor contact

7.4.1 Pin assignment of connector X1

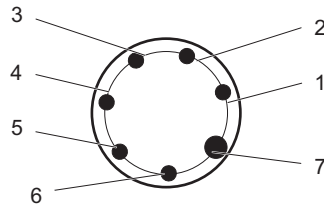

Pin assignment of connector X1 (7-pin)

View of male receptacle X1 on the valve (internal thread, pin contacts)

Contact	Assignment	Description
1	Analog input 0	Current or voltage input referenced to pin 2, setpoint Q
2	Reference point for analog input 0	Reference point for pin 1
3	Digital enable input	Enable referenced to GND
4	Analog output 0	4–20 mA or 2–10 V referenced to GND, actual value Q
5	Digital output 0 Optional digital output 1	Standby Monitoring with respect to GNDOp
6	supply voltage	Nominal 24 V (18–32 V) DC based on GND
7	GND, supply zero or signal zero	GND ⇒ Chap. "7.12 Protective grounding, equipotential bonding, and shielding" , page 90

Fig. 15: Assignment of service connector X1 (7-pin)

⇒ [Chap. "7.14 Wiring connector X1"](#), page 102

7.4.2 Mating connector for connector X1

The mating connector for the 7-pin connector X1 is available as an accessory.

⇒ [Chap. "12.1 Accessories for valves in the D67XK series"](#), page 222

⇒ [Chap. "7.13 Permissible lengths for connection cables"](#), page 98

Mating connector for connector X1

7.4.3 Power supply

CAUTION

Risk of personal injury due to insufficient electrical safety

The insulating elements used are designed for the safety extra low voltage range. The circuits of the fieldbus connections, if provided, are only functionally isolated from other connected circuits.

Compliance with the safety regulations requires that the equipment be isolated from the mains system in accordance with [EN 61558-1](#) and [EN 61558-2-6](#) that all voltages be limited in accordance with [EN 60204-1](#).

- ▶ Nominal signal: see nameplate.
- ▶ Only use SELV/PELV power supplies

CAUTION

Risk of EMC damage!

Improper electrical connections can damage the valve electronics and destroy the fieldbus communication.

- ▶ Make the electrical connection so that it is EMC-appropriate.

The supply voltage must be nominally 24 V (18–32 V) DC referenced to supply zero. Supply voltages of less than 18 V are detected by the valve electronics as undervoltage.

The valve electronics are protected against polarity reversal of the connections.

The power consumption of the valves varies from model to model. Detailed information can be found in the product-specific valve user manual.

Requirement of supply voltage

7.5 Analog inputs/outputs

The analog inputs/outputs are available on service connector X1 and analog inputs optionally on connectors X5, X6, and X7. The analog inputs can measure both current and voltage. connectors X5

Analog inputs/outputs

7.5.1 Analog inputs

All current and voltage inputs are differential, but can be connected to ground (single-ended) by means of external wiring. The analog inputs of connector X1 have a resolution of 12 bits.

⇒ [Chap. "7.14.1 Single-ended command signals", page 103](#)

7.5.1.1 Signal types

The analog inputs on service connector X1 are available in the following versions:

- ± 10 V
- 0–10 V
- ± 10 mA
- 0–10 mA
- 4–20 mA

Signal types of the analog inputs on service connector X1

Which signal type is set for the analog inputs on delivery depends on the valve model. The signal types can be configured via the firmware.



Detailed information can be found in the "Firmware" User Manual.

Signal type for the analog input: ± 10 V

In the case of this signal type, the input is configured as a differential voltage input with a ± 10 V input range.

Analog input: ± 10

The differential input resistance is 20 k Ω .

The input resistance referenced to supply zero is approx. 150 k Ω .

The potential difference of each input to supply zero must be between -15 V and 32 V.

If there is no differential analog source available, the reference point of the analog input (pin 5) must be connected to 0 V of the analog source.

Signal type for the analog input: 0–10 V

In the case of this signal type, the input is configured as a differential voltage input with a 0–10 V input range.

Analog input: 0 –10 V

The differential input resistance is 20 k Ω .

The input resistance referenced to supply zero is approx. 150 k Ω .

The potential difference of each input to supply zero must be between -15 V and 32 V.

If there is no differential analog source available, the reference point of the analog input (pin 5) must be connected to 0 V of the analog source.

Signal type for the analog input: ± 10 mA

With this signal type, the input current to be measured is directed via the two input pins to an internal shunt.

Analog input: ± 10 mA

The differential input resistance is 200 k Ω .

The input resistance referenced to supply zero is approx. 150 k Ω .

CAUTION**Risk of valve electronic damage!**

The input current must be between -25 mA and 25 mA. Input currents outside this permissible range will destroy the input.

- ▶ Only use SELV/PELV power supplies.
- ▶ Heed the correct dimensioning of the cables.

The potential difference of each input to supply zero must be between -15 V and 32 V.

If there is no floating analog source available, the reference point of the analog input (pin 5) must be connected to 0 V of the analog source.

Signal type for the analog input: 0–10 mA

With this signal type, the input current to be measured is directed via the two input pins to an internal shunt.

Analog input: 0–10 mA

The differential input resistance is 200 k Ω .

The input resistance referenced to supply zero is approx. 150 k Ω .

CAUTION**Risk of valve electronic damage!**

The input current must be between -25 mA and 25 mA. Input currents outside this permissible range will destroy the input.

- ▶ Only use SELV/PELV power supplies.
- ▶ Heed the correct dimensioning of the cables.

The potential difference of each input to supply zero must be between -15 V and 32 V.

If there is no floating analog source available, the reference point of the analog input (pin 5) must be connected to 0 V of the analog source.

Signal type for the analog input: 4–20 mA

With this signal type, the input current to be measured is directed via the two input pins to an internal shunt.

Analog input: 4–20 mA

The differential input resistance is 200 k Ω .

The input resistance referenced to supply zero is approx. 150 k Ω .

CAUTION**Risk of valve electronic damage!**

The input current must be between -25 mA and 25 mA. Input currents outside this permissible range will destroy the input.

- ▶ Only use SELV/PELV power supplies.
- ▶ Heed the correct dimensioning of the cables.

The potential difference of each input to supply zero must be between -15 V and 32 V.

If there is no floating analog source available, the reference point of the analog input (pin 5) must be connected to 0 V of the analog source.

In the 4–20 mA signal range signals of $I_{in} < 3$ mA (e.g. due to a defective electric cable) signify a fault, which can be evaluated by the valve software. The monitoring must be activated in the valve software.

7.5.2 Analog outputs**Analog outputs 4–20 mA**

The reference point for the 4–20 mA analog outputs is supply zero. The load impedance must be in the range of 0–500 Ω .

Analog output: 4–20 mA

Cable break detection of the connected cable can be effected with the 4–20 mA analog outputs.

The 4–20 mA analog outputs are short-circuit protected.

⇒ [Chap. "7.14.2.1 Valves with 7-pin connector X1", page 104](#)

Analog outputs 2–10 V

The reference point for the 2–10 V analog outputs is supply zero. The internal resistance is 500 Ω .

Analog output: 2–10 V

Cable break detection of the connected cable can be effected with the 2–10 V analog outputs.

Voltage drops in the supply cable to the valve electronics can result in deviations from the actual value. Therefore, this variant is not recommended.

⇒ [Chap. "7.14.1 Single-ended command signals", page 103](#)

Recommendation: Use a 4–20 mA analog output and terminate directly at the measurement input with 500 Ω . This way you get a 2-10V output without the disadvantages mentioned above.

⇒ [Chap. "7.14.2 Conversion of actual value output signals \$I_{out}\$ ", page 104](#)

7.6 Digital inputs/outputs

The digital inputs/outputs are available on connector X1 depending on the model. The digital input serves as the enable input. Depending on the configuration, the digital output indicates specific events, such as for example the occurrence of a fault.

Digital inputs/outputs

7.6.1 Digital input

Digital enable input

Signals between 8.5 V and 32 V supply voltage referenced to supply zero at the enable input are identified as an enable signal.

Enable input

Signals of less than 6.5 V at the enable input are identified as enable not issued. The electrical output stage is deactivated if no enable is issued or, depending on the versions, set to "HOLD".

This input is also used to acknowledge a valve fault state via an analog signal.

The input current of the digital enable input is 2.3 mA when connected to 24 V.



Detailed information can be found in the "Firmware pQ" user manual.

7.6.2 Digital outputs

The digital outputs are short-circuit protected and switch off in the event of overload. After a period of cooling down, the digital output switches itself back on. Overload means a current load greater than 1.5 A. However, the total current consumption of the valve must be limited by a fuse.

Valve standby

High Supply voltage connected.

Low Supply voltage disconnected (10 k Ω to supply zero).

Logic level

7.7 Digital signal interface

The digital signal interface is available on connector X2.
A digital transducer can be connected to this signal interface.

Connector X2 is available in the following versions:

- 7-pin SSI transducer connector X2
⇒ [Chap. "7.7.1 SSI transducer", page 75](#)

7.7.1 SSI transducer

This digital signal interface is suitable in accordance with [EIA 422](#) for connecting e.g. position transducers or rotary transducers with an SSI interface.
⇒ [Chap. "7.15 Wiring SSI transducers \(X2\)", page 105](#)

The following transducer types are supported:

- Coded with binary code
- Coded with Gray Code

Supported types of SSI transducers

The digital signal interface must be configured.



Detailed information can be found in the "Firmware" User Manual.

The signal levels conform to the standard [EIA 422](#).

Recommended cable types

Use exclusively shielded cables with copper braiding shielding with min. 80% overlap.
Copper conductors with a cross section of at least 0.25 mm².
Use cables with twisted-pair conductors in environments with high background noise levels.

Recommended cable types for SSI transducer

Cable break monitoring

Inputs CLK and DATA of the digital signal interfaces are monitored for cable break – regardless of which transducer type is connected.
The status of cable break monitoring can be read out via fieldbus. The reaction to a cable break is configurable.

Cable break monitoring



Detailed information can be found in the "Firmware" User Manual.

7.7.1.1 Pin assignment SSI transducer connector X2

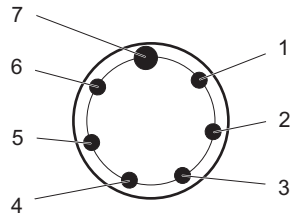

**SSI transducer
connector X2**

View of the SSI encoder female
receptacle X2 on the valve (external
thread, socket contacts)

Contact	Assignment	Description
1	CLK+	Clock pulse output
2	CLK-	
3	DATA+	Data input for transducer data
4	DATA-	
5	SensorSup	Supply voltage to SSI transducer 24 V / 5 V / 0 V (configurable; see "Firmware" User Manual) $I_{\max} = 300 \text{ mA}$
6	GND	Supply zero
7		not used

Fig. 16: SSI transducer connector X2

Power supply to the transducer

Power is supplied to the transducer via pin 5 on connector X2.

Power supply to the transducer



There is joint fusing of this power supply for X2, X5, X6 and X7.
The entire supply current may not exceed the following value:
 $I_{\max} (X2+X5+X6+X7) = 300 \text{ mA}$

The 24 V or 5 V supply voltage is configurable (see "Firmware" User Manual).
An external power supply to the transducer is also possible. However, the 0 V
transducer supply must be connected to supply zero.

The supply voltage is cut off in the event of a possible short circuit in the supply
voltage to the transducer. A fault reaction can be configured (see "Firmware"
User Manual). The voltage is available again as soon as the short circuit has
been eliminated.

7.8 Fieldbus connectors X3 and X4

Fieldbus connectors X3 and X4 are available in the following versions:

- 4-pin CAN connector
⇒ Chap. "7.8.1 CAN connectors", page 77
- 4-pin Profibus-DP connector
⇒ Chap. "7.8.2 Profibus-DP connectors", page 78
- 4-pin EtherCAT connector
⇒ Chap. "7.8.3 EtherCAT connectors", page 80

Versions of the fieldbus connector

7.8.1 CAN connectors

The CAN bus has the following features:

- Multi-master system: Each node can transmit and receive
- Topology: Line structure with short stub lines
- Network expansion and transmission rates:
25 m at 1 Mbit/s to 5,000 m at 25 kbit/s
- Addressing type: Message-orientated via identifiers
Priority assignment of messages possible via identifiers
- Security: Hamming distance = 6, i.e. up to 5 individual errors per message are detected
- Physical bus: [ISO 11898](#)
- Max. nodes: 127 (via repeater)

7.8.1.1 Technical data for the CAN bus interface

EMC protection requirements	Immunity to interference as per EN 61000-6-2 (evaluation criterion-A) Emitted interference as per EN 61000-6-4
Connectors X3 and X4	In each case a 4-pin plug connector with socket connectors (eXLink plug connector Fa. CEAG, coding 1h) ⇒ Chap. "7.8.1.2 Pin assignment, CAN connectors", page 78
Physical	ISO 11898 CAN-HIGH SPEED
Maximum voltage capacity	±40 V long-term (between CAN_H and CAN_L) ±500 V long-term referenced to supply zero (optical isolation) ±2.5 ESD (classification A: Human Body Model, C = 100 pF, R = 1.5 kΩ)
Maximum permissible number of CAN bus nodes	32 or 110 ⇒ Chap. "7.16.2 Permissible number of CAN bus nodes", page 110

Tab. 9: Technical data for the CAN bus interface

7.8.1.2 Pin assignment, CAN connectors

CAN connectors X3 and X4

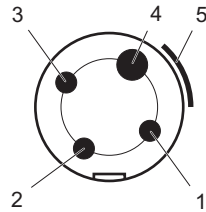

View of CAN female receptacle X3 and X4 on the valve (external thread, socket contacts)

Contact	Assignment	Description
1	CAN_V+	Not connected in the valve
2	CAN_GND	CAN terminal resistor
3	CAN_H	Transceiver H
4	CAN_L	Transceiver L
5	CAN_SHLD	Shield (applied on the control cabinet side)

Fig. 17: CAN connectors X3 and X4

CAUTION

Danger of property damage due to improper plug connection!

In order to avoid damage to the explosion proof connector:

- ▶ Heed the notes and instructions in the "Ex connector eXLink" operating instructions.

7.8.2 Profibus-DP connectors

The Profibus-DP has the following features:

- Standardized in accordance with [EN 61158-2](#) (type 3)
- Multi-master system:
Masters share access time and initiate communication.
Slaves react only on request.
- Topology: Line structure with short stub lines
- Network expansion and transmission rates:
100 m at 12 Mbit/s to 1,200 m at 9.6 kbit/s per segment
Use of repeaters possible
- Addressing type: address-oriented
Priority/cycle time assignment of messages via master configuration
- Physical bus: RS 485 according to [TIA/EIA-485-A](#)
Max. nodes: 127

7.8.2.1 Technical data for the Profibus-DP interface

EMC protection requirements	Immunity to interference as per EN 61000-6-2 (evaluation criterion-A) Emitted interference as per EN 61000-6-4
Connectors X3 and X4	In each case a 4-pin plug connector with socket connectors (eXLink plug connector Fa. CEAG, coding 5h) ⇒ Chap. "7.8.2.2 Pin assignment, Profibus-DP connectors", page 80
Physical	Conformity as per test specification "PROFIBUS slaves Version 2.0 of the PNO, Order-No: 2.032"
Maximum voltage capacity	-9 V to 14 V (long-term) from signal cable to Profi GND ±500 V long-term referenced to supply zero (optical isolation) ±40 V with a pulse of 15 µs via a resistance of 100 Ω with an edge duration < 100 ns.
Maximum permissible number of Profibus-DP nodes	32 bus nodes without repeater With repeater up to 126 nodes

Technical data for the Profibus-DP interface

Tab. 10: Technical data for the Profibus-DP interface

7.8.2.2 Pin assignment, Profibus-DP connectors

Profibus DP connectors X3 and X4

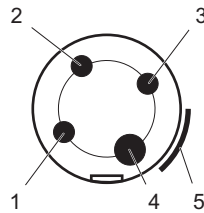

View of the Profibus-DP female receptacle X3 and X4
on the valve (external thread, socket contacts)

Contact	Assignment	Description
1	Profibus V+	Terminal resistors for RXD/TXD-P
2	Profibus A	RXD/TXD-N
3	Profibus GND	Terminal resistors for RXD/TXD-N
4	Profibus B	RXD/TXD-P
5	Shield	Positioned on control cabinet side

Fig. 18: Profibus DP connectors X3 and X4

CAUTION

Danger of property damage due to improper plug connection!

In order to avoid damage to the explosion proof connector:

- ▶ Heed the notes and instructions in the "Ex connector eXLink" operating instructions.

7.8.3 EtherCAT connectors

The EtherCAT bus has the following features:

- Standardized in accordance with [IEC 62407](#)
- Single-master system:
The master initiates communication.
Slaves react only on request.
- Topology:
Line, star, tree and ring structure based on the daisy chain principle
- Network expansion and transmission rates:
100 m between two nodes at 100 Mbit/s
- Addressing type: Address-orientated, one telegram for all nodes
- Physical bus: Fast Ethernet
- Max. nodes: 65,535

7.8.3.1 Technical data for the EtherCAT interface

EMC protection requirements	Immunity to interference as per EN 61000-6-2 (evaluation criterion-A) Emitted interference as per EN 61000-6-4
Connectors X3 and X4	In each case a 4-pin plug connector with socket connectors (eXLink plug connector Fa. CEAG, coding 5h) ⇒ Chap. "7.8.3.2 Pin assignment, EtherCAT connectors", page 82
Physical	4-core, paired cable as per CAT 5 for 100-Base-TX transmission Network topology: Tree and line Termination: device-internal Transmission rate: 100 Mbit/s As per EN 61158-2 Type 12 EtherCAT, "PHYSICAL LAYER SPECIFICATION AND SERVICE DEFINITION" and ISO/IEC 8802-3 100 Base-TX (IEEE 802.3 Section 24)
Maximum voltage capacity	±500 V long-term referenced to supply zero (optical isolation)
Maximum permissible number of EtherCAT bus nodes	65.536 The maximum number of nodes in a fieldbus line is 216.

Technical data for the EtherCAT interface

Tab. 11: Technical data for the EtherCAT interface

7.8.3.2 Pin assignment, EtherCAT connectors

EtherCAT connectors X3 and X4

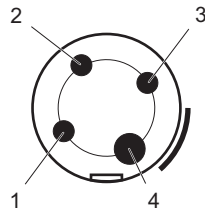

View of the EtherCAT female receptacle X3 and X4 on the valve (external thread, socket contacts)

Contact	Assignment	Description
1	TX+	Transmit
2	RX+	Receive
3	TX-	Transmit
4	RX-	Receive

Fig. 19: EtherCAT connectors X3 and X4

CAUTION

Danger of property damage due to improper plug connection!

In order to avoid damage to the explosion proof connector:

- ▶ Heed the notes and instructions in the "Ex connector eXLink" operating instructions.

To connect the valves to an EtherCAT network, we recommend molded cord sets with an integral straight mating connector.

⇒ [Chap. "7.18 Wiring EtherCAT networks \(X3, X4\)", page 114](#)

7.9 Analog input connectors X5, X6 and X7

The analog inputs of connectors X5, X6 and X7 have a resolution of 14 bits.

7.9.1 Pin assignment, analog input connectors X5, X6 and X7

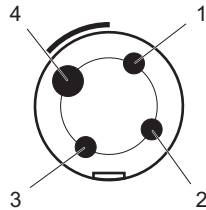

View of the analog input female receptacle X5, X6 and X7 on the valve
(external thread, socket contacts)

Analog input
connectors X5, X6 and X7

Contact	Assignment	Description
1	Transducer supply	+24 V, $I_{\max} (X2+X5+X6+X7) = 300$ mA referenced to pin 3
2	Reference point of analog input	Reference point for pin 4
3	Transducer supply 0 V	Supply zero
4	Analog input	Current or voltage input referenced to pin 2

Fig. 20: Analog input connectors X5, X6 and X7

⇒ Chap. "7.19 Wiring analog inputs (X5, X6, X7)", page 117

Power supply to the transducer

The transducer is supplied with power via pin 1 of connectors X5, X6 and X7.

⇒ Fig. 20, page 83



There is joint fusing of this power supply for X2, X5, X6 and X7. The entire supply current may not exceed the following value:
 $I_{\max} (X2+X5+X6+X7) = 300$ mA

Power supply to
the transducer at
connectors X5, X6, X7

An external power supply to the transducer is also possible. However, the 0 V transducer supply must be connected to supply zero. An interruption of the transducer supply current can be identified as a cable break (see "Firmware" User Manual).

The supply voltage is cut off in the event of a possible short circuit in the supply voltage to the transducer. A fault reaction can be configured (see "Firmware" User Manual). The voltage is available again as soon as the short circuit has been eliminated.

7.9.2 Signal types

The analog inputs are available in the following versions:

- ± 10 V
- 0–10 V
- 0–10 mA
- 4–20 mA

Signal types of the analog inputs at connectors X5, X6, X7

The inputs can be operated in each case differentially or single-ended (one input cable referenced to supply zero).

Which signal type is set for the analog inputs on delivery depends on the valve model. The signal types can be configured via the firmware.



Detailed information can be found in the "Firmware" User Manual.

Signal type for the analog input: ± 10 V

In the case of this signal type, the input is configured as either a differential or a single-ended voltage input with a ± 10 V input range.

⇒ [Chap. "7.9.3 Input resistances", page 85](#)

Analog input: ± 10

The potential difference of each input to supply zero must be between -15 V and 32 V.

If there is no differential analog source available, the reference point of the analog input (pin 2) must be connected to 0 V of the analog source.

Signal type for the analog input: 0–10 V

For this signal type, the input is either configured as a differential or as a single-ended voltage input with 0–10 V input range.

⇒ [Chap. "7.9.3 Input resistances", page 85](#)

Analog input: 0 –10 V

The potential difference of each input to supply zero must be between -15 V and 32 V.

If there is no differential analog source available, the reference point of the analog input (pin 2) must be connected to 0 V of the analog source.

Signal type for the analog input: 0–10 mA

In the case of this signal type, the input is configured as either a differential or a single-ended current input with a 0–10 mA input range.

⇒ [Chap. "7.9.3 Input resistances", page 85](#)

Analog input: 0–10 mA

The analog input is deactivated in the event of an excessively high input current.

The potential difference of each input to supply zero must be between -15 V and 32 V.

If there is no floating analog source available, the reference point of the analog input (pin 2) must be connected to 0 V of the analog source.

Signal type for the analog input: 4–20 mA

In the case of this signal type, the input is configured as either a differential or a single-ended current input with a 4–20 mA input range.

⇒ Chap. "7.9.3 Input resistances", page 85

The analog input is deactivated in the event of an excessively high input current.

The potential difference of each input to supply zero must be between -15 V and 32 V.

If there is no floating analog source available, the reference point of the analog input (pin 2) must be connected to 0 V of the analog source.

In the 4–20 mA signal range signals of $I_{in} < 3$ mA (e.g. due to a defective electric cable) signify a fault, which can be evaluated by the valve software. The monitoring must be activated in the valve software.

Analog input: 4–20 mA

7.9.3 Input resistances

The input resistances of the analog inputs are dependent on the set signal type and the version.

Input resistances

Signal type	Version	R_D	R_1	R_2
Voltage ± 10 V; 0–10 V	Differential	200 k Ω	250 k Ω	10 k Ω
	Single-ended	200 k Ω	250 k Ω	< 12 Ω
Current 0–10 mA; 4–20 mA	Differential	240 Ω	100 k Ω	10 k Ω
	Single-ended	252 Ω	100 k Ω	< 12 Ω

Tab. 12: Input resistances X5, X6, X7

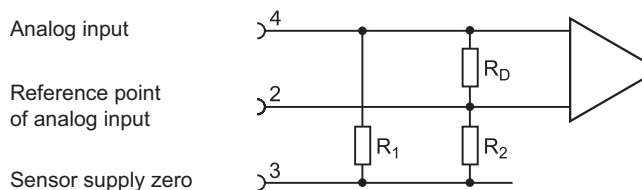
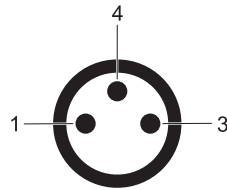

Fig. 21: Equivalent circuit diagram of analog input

7.10 Service connector X10

This interface serves to connect diagnostic and start-up tools and is available on connector X10.

Service connector X10



View of service connector X10
(external thread, pin contacts)

**Service connector X10
(M8, 3-pin)**

Contact	Assignment	Description
1	CAN_H	Transceiver H
3		Not assigned
4	CAN_L	Transceiver L

Fig. 22: Service connector X10 (M8, 3-pin)

Valves without CAN bus interfaces can be started up and configured via the service interface (service connector X10) with the Moog Valve and Pump Configuration Software.

WARNING



Danger of explosion!

To guarantee safe operation in hazardous areas.

- ▶ In its standard model with screw plug, the service connector X10 is not permitted for use in hazardous areas.
- ▶ For mounting of the screw plug of the service connector X10, it must be observed that the gasket and the threads of the screw plug as well as the threads in the electronic housing of the valve are not damaged.
- ▶ In case of damage to the screw plug of the service connector or the threads in the electronic housing, the valve must not be operated in hazardous areas.
- ▶ Tightening torque screw plug:
⇒ [Chap. "3.1.2 Representative depiction of the valve", page 18](#)

DANGER**Danger of explosion!**

An explosion can be triggered by sparks when switching on the machine.

- ▶ Open connectors for the interface must absolutely be covered before start-up.
- ▶ The eXLink connectors from CEAG must be mounted according to the instructions in the operating instructions for the eXLink connectors.
- ▶ In the standard model with a screw plug, the service connector X10 is not permitted for use in hazardous areas.
- ▶ The service connector X10 in the standard model M8, 3-pin must be sealed with the original screw plug belonging to the valve before start-up.
- ▶ When mounting the screw plug for the service connector X10, it must be observed that the gasket and the thread of the screw plug as well as the thread in the electronic housing of the valve are not damaged.
- ▶ In case of damage to the screw plug for the service connector X10 or the threads in the electronic housing, the valve must not be operated.
- ▶ Tightening torque for screw plug:
⇒ [Chap. "3.1.2 Representative depiction of the valve", page 18](#)



For the standard model of the valve, the service interface is not suitable for use in hazardous areas. On request, the service interface is available in an explosion-proof model.

7.11 General notes on wiring

DANGER



Danger of explosion!

An explosion can be triggered by sparks when switching on the machine.

- ▶ Open connectors for the interface must absolutely be covered before start-up.
- ▶ The eXLink connectors from CEAG must be mounted according to the instructions in the operating instructions for the eXLink connectors.
- ▶ In the standard model with a screw plug, the service connector X10 is not permitted for use in hazardous areas.
- ▶ The service connector X10 in the standard model M8, 3-pin must be sealed with the original screw plug belonging to the valve before start-up.
- ▶ When mounting the screw plug for the service connector X10, it must be observed that the gasket and the thread of the screw plug as well as the thread in the electronic housing of the valve are not damaged.
- ▶ In case of damage to the screw plug for the service connector X10 or the threads in the electronic housing, the valve must not be operated.
- ▶ Tightening torque for screw plug:
⇒ [Chap. "3.1.2 Representative depiction of the valve", page 18](#)

7.11.1 Tools and materials required

WARNING



Danger of explosion!

To guarantee safe operation in hazardous areas:

- ▶ The signal interfaces of the valve are implemented with explosion-proof connectors.
- ▶ For mounting and removal of the connectors as well as operation of the valve, the notes and instructions in the "Explosion-proof connectors eXLink, CEAG" operating instructions must absolutely be adhered to.

CAUTION

Danger of property damage due to improper plug connection!

In order to avoid damage to the explosion proof connector:

- ▶ Heed the notes and instructions in the "Ex connector eXLink" operating instructions.

The following are required for electrically connecting the valves:

- Mating connector for connector X1 (7-pin)
- Connection cables for mating connector
- Crimping tool for mating connector with corresponding crimping insert
- Installation tool

Tool required

The above-mentioned connectors, cables and tools are not included in the valve scope of delivery. They are supplied separately.

⇒ Chap. "12.1 Accessories for valves in the D67XK series", page 222

7.11.2 Procedure

Procedure for electrically connecting the valve:

Procedure for electrical connection

1. Conduct electrical connection in accordance with the pin assignment.
⇒ Chap. "7.4 Connector X1", page 69
2. Establish equipotential bonding, protective grounding and electrical shielding.
⇒ Chap. "7.12 Protective grounding, equipotential bonding, and shielding", page 90
⇒ Chap. "7.13 Permissible lengths for connection cables", page 98
3. Valves with fieldbus interface: wire fieldbus.
⇒ Chap. "7.16 Wiring CAN networks", page 106
⇒ Chap. "7.17 Wiring Profibus-DP networks (X3, X4)", page 111
4. Check whether all the connectors and if necessary the service connector to which no mating connector is attached are covered with a suitable dust protection cap.
5. If necessary, put a dust protection cap on.



Make sure to heed the instructions and notes in the eXLink plug connector operating instructions from CEAG.

7.11.3 Wiring of supply lines, evaluation of digital and analog signals

Activation of the analog inputs with differential signals is to be preferred. If the signal cannot be transmitted differentially, the reference point of the input at the valve must be connected to ground (supply zero).

⇒ Chap. "7.14.1 Single-ended command signals", page 103

Because current inputs have a lower input resistance than voltage inputs and are thus immune to interference, activation with a current signal is to be preferred to activation with a voltage signal.

Evaluating the different signal types

Signal type	Benefits
±10 V or 0–10 V	Simple measurement of the signal, e.g. with an oscilloscope.
±10 mA or 0–10 mA	Large transmission lengths are possible.
4–20 mA	Detection of faults in the electrical line and large transmission lengths are possible.

Benefits of the different signal types for analog inputs

Tab. 13: Benefits of the different signal types for analog inputs

7.12 Protective grounding, equipotential bonding, and shielding

7.12.1 Overview

The valves with integrated electronics are equipped with a protective conductor connection (⊕) in the connector or on the valve body in accordance with the requirements of the standard [EN 60204](#).

This chapter contains guidelines on protective grounding and electrical shielding of cables in applications in which the valves with integrated electronics are used.

Guidelines for protective grounding

CAUTION



Danger of personal injury and damage to property!

Improper grounding and shielding can cause damage, malfunctions or failures of valves or the machine.

- ▶ The valves should only be used in such machines and plants that comply with the requirements of the standard [EN 60204-1](#) and this chapter.

CAUTION

Risk of personal injury due to insufficient electrical safety

Compliance with the safety regulations requires that the equipment be isolated from the mains system in accordance with [EN 61558-1](#) and [EN 61558-2-6](#) that all voltages be limited in accordance with [EN 60204-1](#).

- ▶ Only use SELV/PELV power supplies!

7.12.2 Equipotential bonding and protective grounding

- The purpose of equipotential bonding is to establish as small a potential difference as possible within the machine.
- Protective grounding serves to maintain safety while the machine is in operation.
- The term protective earth or PE designates only a single point within the machine: the connection point of the external protective conductor. All additional connections to ground (⊕) are established via protective and equipotential bonding conductors.

Equipotential bonding and protective grounding of machines

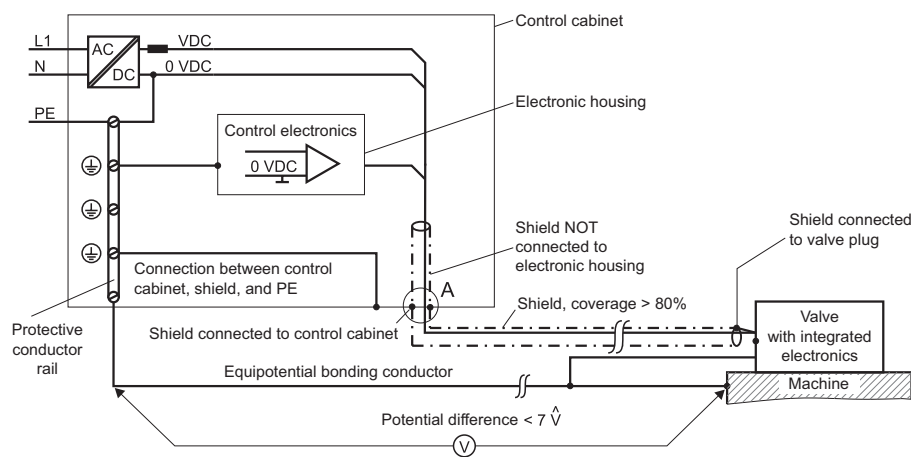

Fig. 23: Equipotential bonding and protective grounding of machines (see also EN 60204-1) and electrical shielding of our valves with integrated electronics

7.12.2.1 General principles

DANGER



Danger of explosion in case of unsafe operation!

In order to create as small a potential difference in the machine as possible and guarantee safe operation of the machine, the equipotential bonding and protective conducting system for a machine in which the valves should be used must be constructed according to EN 60204-1.

- ▶ Connect all elements of the machine to each other via equipotential bonding conductors.
- ▶ Connect all elements of the machine that have exposed metal surfaces via protective conductors to the protective conductor rail.
- ▶ Connect all the protective conductors and the equipotential bonding conductor in the main cabinet via the protective conductor rail to the protective earth (PE) terminal.

Performing equipotential bonding



The cross section of the protective conductor is specified in [EN 60204-1](#), Section 8. The following cross section have proven successful for equipotential bonding conductors:

- up to 200 m cable length: 16 mm²
- up to 200 m cable length: 25 mm²

Required cross section of the protective conductor



The potential difference between any two points within the machine should not be more than 7 V peak (7 \hat{V}).

- Connect the electrical shielding and the electrical ground of the electronics chassis point-to-point to the protective conductor rail.
- Before releasing a machine for normal operation, always check that all equipotential bonding and protective conductors are in proper working order in accordance with [EN 60204-1](#), Section 18.

Maximum potential difference

7.12.2.2 Protective conductor

The valves must essentially only be operated with safe power supplies (SELV/PELV). No dangerous voltages are generated in the valve. Therefore, no protective conductor must be connected.

Requirements of the protective conductor

DANGER



Danger to life!

People can be injured and property damaged through the operation of the valve with an unsafe power supply.

- ▶ Only use SELV/PELV power supplies as per EN 60204-1!

7.12.2.3 Ground loops

If a valve is connected to protective earth (PE) both via the equipotential bonding system and via the valve protective conductor, a compensating current can split in the resulting ground loop. This current can cause serious malfunctions in the machine.

Observe the following points in order to minimize as much as possible malfunctions caused by a ground loop:

- Route the valve supply and signal cables as closely as possible to the equipotential bonding conductor.
⇒ [Chap. "7.12.3 Machines with deficient equipotential bonding", page 94](#)
- The impedance of the equipotential bonding system should be less than 10% of the impedance of the shielding of the lines.

Avoiding ground loops

7.12.3 Machines with deficient equipotential bonding

DANGER



Danger to life due to electric shock!

Very strong current can flow via the shield connection of the valve.

- ▶ Extreme caution is required since for some industrial applications, no good equipotential bonding can be implemented.
- ▶ An effective equipotential bonding system must be set up in compliance with DIN EN 60204-1, Section 8.

Deficient equipotential bonding

7.12.4 Electrical shielding

An effectively shielded machine is to a high degree immune to external interference sources. Furthermore, the interference emitted by the machine is reduced considerably by effective shielding.

Electrical shielding

A functioning equipotential bonding system provides the basis for an effectively shielded machine. To ensure that the cables are effectively shielded, it is essential to satisfy the general requirements with regard to equipotential bonding and protective grounding.

⇒ [Chap. "7.12.2 Equipotential bonding and protective grounding", page 91](#)

7.12.4.1 Cables

Observe the following points when choosing cables for connecting the valves:

Requirements of cables

- Only use shielded cables.
- The cable shield should be made of copper braiding with a minimum 80 % coverage.
- The individual conductors must be made of copper and have a minimum cross section of 0.2 mm² in accordance with [EN 60204-1](#).
- Use cables with twisted pair conductors in environments with high background noise levels.
- The protective conductor should be guided within the cable shield.
⇒ [Chap. "7.12.2.2 Protective conductor", page 92](#)

7.12.4.2 Connecting the shield



When connecting the shielding, only connectors in the accessories for valves in the D67xK series may be used.

Connection on the valve side

Connect the cable shield conductively to the metal shell of the connector.

Connecting the shield on the valve side

Connection on control cabinet side

Connection on the control cabinet side can be completed with either lead-through cables or connectors.

Connecting the shield on the control cabinet side

Cable leadthrough

Observe the following points when connecting the shield on the control cabinet side:

Connecting the shield with cable leadthrough

- Connect the control cabinet's wall conductively to the protective conductor rail (⊕).
⇒ Fig. 23, page 91
- Connect the cable shield correctly (flat, conductively) to the control cabinet's wall.

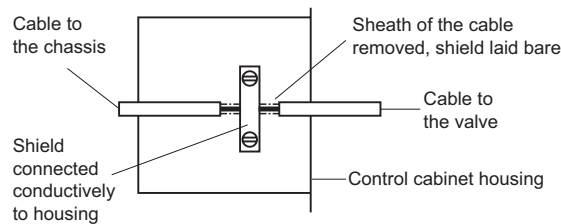

Fig. 24: Connecting the shield to the control cabinet's wall (detail A from Fig. 23)

WARNING



Danger due to electric shock!

The shield of the cable must be laid correctly in order to prevent faults in the machine and injuries to people.

- ▶ Do NOT connect the shield of the cable with the electronics chassis.

- Lead the cable shield without interruption through the wall of the EMC-compliant control cabinet as closely as possible to the electronics chassis, e.g. by means of a cable gland.

Plug connection

Observe the following points when connecting the shield on the control cabinet side:

Connecting the shield with plug connection

- Connect the control cabinet's wall conductively to the protective conductor rail (⊕).
- ⇒ Fig. 23, page 91
- Connect the shield of the cable coming from the valve to the housing of the removable connector.



The housing of the connector permanently mounted in the control cabinet must demonstrate a good-conducting connection with the wall of the control cabinet.

- Connect the connector mounted in the wall of the control cabinet to the shield inside the cabinet.

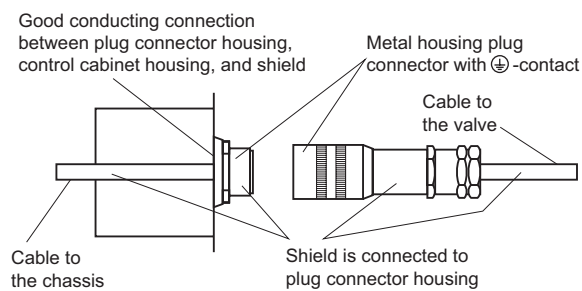

Fig. 25: Connecting the cable shield via connector to the control cabinet's wall (detail A from Fig. 23)

- Lead the shield inside the control cabinet as closely as possible to the electronics chassis.

WARNING



Danger due to electric shock!

The shield of the cable must be laid correctly in order to prevent faults in the machine and injuries to people.

- ▶ Do NOT connect the shield of the cable with the electronics chassis.

7.12.4.3 Insulated shielding

If connecting the shield to both ends of the cable is not desirable, such as in a machine with deficient equipotential bonding, insulated shielding may be required. However, this is normally only necessary if it is not possible to establish a good equipotential bonding system.

Insulated shielding in the event of deficient equipotential bonding

Observe the following points when connecting insulated shielding:

- Use metal shell connectors with a leading protective earth contact-(\ominus) in accordance with [EN 60204-1](#).
- Connect the cable shield conductively to the metal shell of the connector.
- Connect the control cabinet's wall conductively to the protective conductor rail (\ominus).
⇒ [Fig. 23, page 91](#)
- Connect the cable shield via a capacitor (e.g. 10 nF / 100 VDC ceramic capacitor) to the control cabinet's wall.

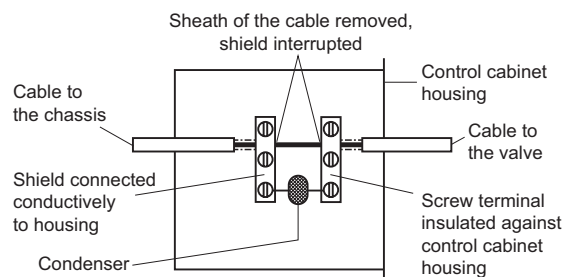

Fig. 26: Connecting the insulated shielding to the control cabinet's wall (detail A from Fig. 23)

- Install a separate shield connected to the control cabinet's wall inside the control cabinet. Route this shield as closely as possible to the electronics chassis.

WARNING



Danger due to electric shock!

The shield of the cable must be laid correctly in order to prevent faults in the machine and injuries to people.

- ▶ Do NOT connect the shield of the cable with the electronics chassis.

7.12.4.4 Cable routing

The routing of the cable inside a machine must comply with the following general guidelines:

Cable routing inside the machine

- Route supply and signal cables in separate cable conduits.
- In order to minimize malfunctions caused by a ground loop, route the valve connection cables as closely as possible to the equipotential bonding conductor.
⇒ [Chap. "7.12.2.3 Ground loops", page 93](#)
- Do not route cable conduits near strong electromagnetic interference sources, such as electric motors or transformers.
- If the cable routing cannot eliminate the risk of lightning strokes completely, suitable protective measures must be taken, as described in [EN 60204-1](#).

7.13 Permissible lengths for connection cables

7.13.1 Introduction

The valves with integrated electronics are supplied via 24 V supply cables and controlled via analog or fieldbus cables.

Dimensioning of supply and signal cables

This section of the chapter is intended to serve as a guide to dimensioning and configuring supply and signal cables in order to guarantee adequate supply voltage and signal quality for all the permissible valve operating states.

The maximum permissible length of supply and signal cables is limited by the resistance and the capacitance per unit length of the cables.

7.13.2 Typical values for copper cables

The typical values specified here are used in the example calculations in the following sections.

7.13.2.1 Resistance of cable

The typical resistance R_{typ} of a copper cable of length- l is calculated as follows:

Calculating the resistance

$$R_{\text{typ}} = \frac{\rho_{\text{Cu}}}{q_{\text{typ}}} \cdot l = 23.73 \frac{\text{m}\Omega}{\text{m}} \cdot l$$

$$q_{\text{typ}} = 0,25 \text{ mm}^2 \quad \text{Typical cross section used for connection cables}$$

$$\rho_{\text{Cu}} = 0.0178 \frac{\Omega \text{mm}^2}{\text{m}} \quad \text{Resistivity of copper at } 20 \text{ }^\circ\text{C}$$

7.13.2.2 Capacitance of cable

The typical capacitance per unit length of copper cables is 50 pF/m.

The typical capacitance C_{typ} of a copper cable of length- l is calculated as follows:

Calculating the capacitance

$$C_{\text{typ}} = 50 \frac{\text{pF}}{\text{m}} \cdot l$$

7.13.3 24 V supply cables

The maximum permissible length l_{\max} of the supply cable is calculated as follows:

Calculating the maximum length of supply cables

$$I_{\max} = \frac{U_{\text{dr_max}}}{\left(\frac{U_{\text{ab}}}{l}\right)_{\text{typ}}}$$

$$U_{\text{dr_max}} = I_{\max} \cdot \left(\frac{U_{\text{ab}}}{l}\right)_{\text{typ}}$$

$U_{\min} = 18 \text{ V}$ Lowest permissible supply voltage for valve

$U_{\text{dr_max}} = 6 \text{ V}$ Maximum permissible voltage drop over the supply cable

$$U_{\text{dr_max}} = 24 \text{ V} - U_{\min}$$

$\left(\frac{U_{\text{ab}}}{l}\right)_{\text{typ}}$ voltage drop per unit length
 ⇒ Chap. "7.13.3.1 Voltage drop per unit length", page 99



This calculation does not take into account a possible reduction of the power supply output voltage on account of the connected load. Nor does it take into account any voltage dips that can occur at the moment when additional loads are connected.

7.13.3.1 Voltage drop per unit length

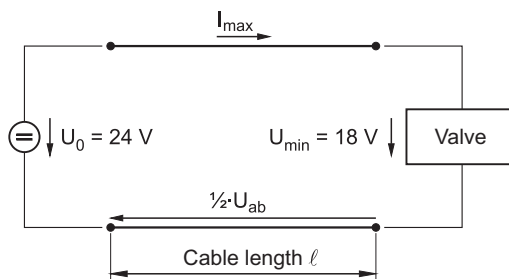

Fig. 27: Voltage drop on the supply cable

The voltage drop per unit length over the forward and return lines of the supply cable is calculated as follows:

$$\left(\frac{U_{\text{ab}}}{l}\right)_{\text{typ}} = 2 \cdot I_{\max} \cdot \left(\frac{R_{\text{typ}}}{l}\right) = 2 \cdot I_{\max} \cdot 23.73 \frac{\text{m}\Omega}{\text{m}}$$

I_{\max} Maximum current consumption of valve
 (see product-specific valve user manual)

R_{typ} Typical resistance of the cable
 ⇒ Chap. "7.13.2.1 Resistance of cable", page 98

l Length of the supply cable

7.13.3.2 Examples of the voltage drop of supply cables

Valve series	Max. current consumption I_{max}	Voltage drop $\left(\frac{U_{ab}}{l}\right)_{typ}$	Max. permissible cable length l_{max}
D67xK + D94xK	350 mA	17 mV/m	364 m

Examples of the voltage drop of supply cables

Tab. 14: Examples of the voltage drop of supply cables as a function of the cable length for a cable cross section of 0.75 mm²

7.13.4 Analog signal cables

Influence of resistance R

The influence of the resistance-R of the cable used on the maximum cable length l_{\max} for signal cables is very low, as the currents flowing through signal cables are very small.

Influence of resistance-R

Example:

For a cable length-l of 428 m the resistance-R according to the formula below is only 10 Ω .

$$R = \frac{\rho_{Cu}}{q_{typ}} \cdot l = 23.73 \frac{m\Omega}{m} \cdot 428 \text{ m} \approx 10 \Omega$$

Influence of capacitance per unit length

The influence of the capacitance per unit length of the cable used on the maximum cable length l_{\max} for signal cables is considerably greater.

Influence of capacitance per unit length

The capacitance C that increases with the cable length forms with the input resistance R of an analog input a high pass of the first order, which can couple high-frequency interference for example at signal inputs. The limit frequency- f_l of the high pass is calculated as follows:

Calculating the limit frequency

$$f_g = \frac{1}{2 \cdot \pi \cdot R \cdot C}$$

The longer the cable, the lower the limit frequency- f_l of the high pass.

Example:

A cable length l of 10 m and a typical analog input resistance R of 10 k Ω produce according to the formula below a limit frequency f_l of 32 kHz.

$$f_g = \frac{1}{2 \cdot \pi \cdot R \cdot C} = \frac{1}{2 \cdot \pi \cdot R \cdot 50 \frac{pF}{m} \cdot l}$$

$$f_g = \frac{1}{2 \cdot \pi \cdot 10 \text{ k}\Omega \cdot 50 \frac{pF}{m} \cdot 10 \text{ m}}$$

$$f_g = 32 \text{ kHz}$$

Recommendations

With a differential voltage command signal and a cable length-l of 10 m the EMC test was conducted in accordance with [EN 61000-6-2](#). The interference on the spool position during the interference (electromagnetic coupling, transient) was below 1 %. This can worsen as the cable is lengthened.

Experience shows that with cable lengths over 15 m a current input should be used, as here the input resistance is smaller by a factor of 50.

Current input with cable length > 15 m

The limit frequency- f_l of the high pass also increases by the same factor, and with it the input becomes more immune to interference.

Furthermore, the voltage drop on the cable does not have an effect in the event of a current command signal.

A differential input is always to be recommended, regardless of whether a voltage or current signal is used as the command signal, since interference coupled on the two input cables is subtracted to virtually zero.

Recommendation: differential input

7.13.5 Digital signal cables

7.13.5.1 Digital signal input cables

Digital signal input cables, such as enable, are more non-critical with regard to their cable lengths, because the currents are low (< 20 mA) and a greater noise level distance is easier to maintain, since only two states/levels must be differentiated.

Length of digital signal cables

7.13.5.2 Digital signal output cables

With digital signal output cables, such as monitoring and standby, currents up to 1.5 A are encountered. In these cases, the voltage drop over longer cables can no longer be neglected. Thus, these cables are subject to the same requirements as supply cables.

⇒ Chap. "7.13 Permissible lengths for connection cables", page 98

7.13.5.3 Fieldbus cables

In the case of digital fieldbus cables, the maximum possible cable lengths are very different. For the most part the cable ends are terminated with low resistance (power adaptation) in order to avoid signal reflections, which permits longer cable lengths. The maximum possible cable lengths are laid down in the standards of the relevant fieldbuses and depend among other things on the transmission rate used.

Length of fieldbus cables

7.14 Wiring connector X1

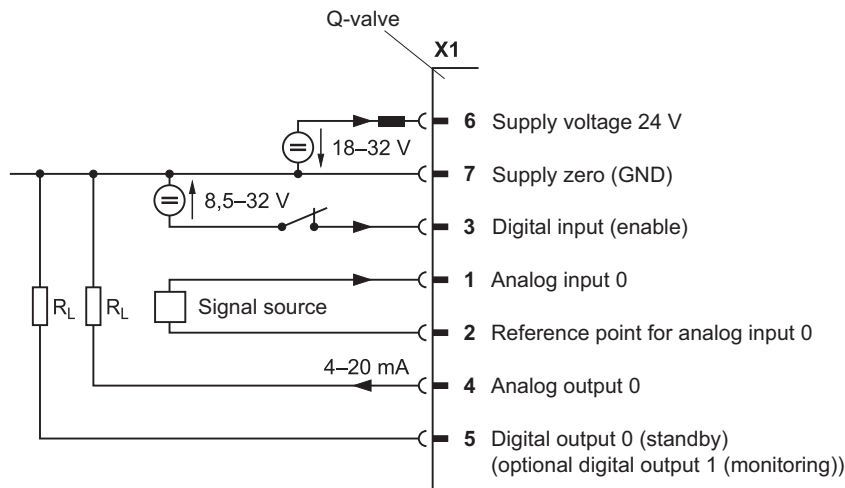

Wiring of the 7-pin connector X1

Fig. 28: Wiring of the 7-pin connector X1

7.14.1 Single-ended command signals

Basically, activation of the command inputs with differential signals is to be preferred. If the command signal cannot be transmitted differentially, the reference point of the command input at the valve must be connected to ground (GND).

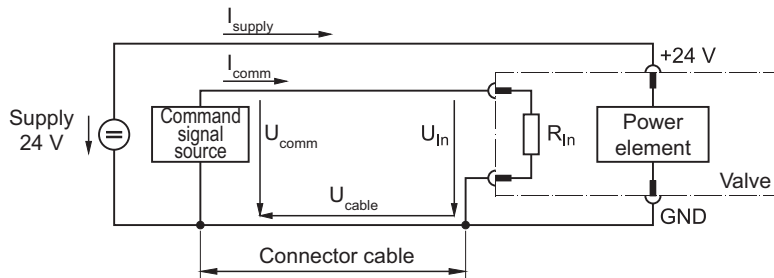

Fig. 29: Circuit for single-ended command signals

If the command inputs are connected to ground (single-ended), the connection cable must be as short as possible and have an appropriately large cross section in order to keep the voltage drop as low as possible.

The voltage drop on the forward and return lines is generated by the supply current I_{Supply} of the valve electronics power circuit. It is proportional to the length of the connection cable and varies according to the valve status.

Maximum permissible cable lengths:

⇒ [Chap. "7.13 Permissible lengths for connection cables", page 98](#)

The voltage drop U_{cable} on the return line and the resulting potential shift of ground (supply zero) results in not the command signal U_{comm} but rather the input voltage U_{in} being applied at the command input in accordance with the following equation:

$$U_{\text{in}} = U_{\text{comm}} - U_{\text{cable}}$$

In the case of command signal sources with impressed current I_{comm} , the potential shift of ground (supply zero) has no effect on the signal. However, changes in the voltage drop resulting from the valve's varying current consumption must be corrected by the command signal source. If current control does not follow the voltage change in terms of time, the command signal at the valve input may also be affected here.



The function of single-ended command inputs is identical to the function of differential command inputs.

Circuit for single-ended command signals

Single-ended connection of the command inputs

$$\text{Input voltage } U_{\text{in}} = U_{\text{comm}} - U_{\text{cable}}$$

Command signal sources with impressed current I_{comm}

7.14.2 Conversion of actual value output signals I_{out}

The actual value output signals I_{out} 4–20 mA can be converted into U_{out} 2–10 V in accordance with the following circuit.

Conversion of actual value output signals I_{out} 4–20 mA into 2–10 V

7.14.2.1 Valves with 7-pin connector X1

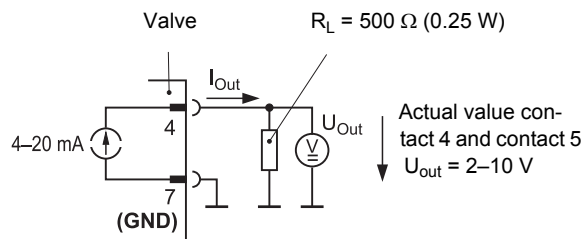

Fig. 30: Circuit for converting the actual value output signals I_{out} (for valves with 7-pin connector X1)

7.15 Wiring SSI transducers (X2)

An SSI transducer delivers an absolute position or angle signal, which can be read in via the digital signal interface.

Wiring SSI transducers (X2)

7.15.1 SSI master mode

In SSI master mode the integrated electronics generate internally the SSI clock signal (CLK) with settable frequencies in the range between 78 kHz and 5 MHz.



Detailed information can be found in the "Firmware" User Manual.

In the rest state the clock signal is at 1. The first falling edge of the clock signal signals to the SSI transducer to maintain its current value. The following rising edge of the clock signal starts the data transmission of the SSI transducer. The output starts with the highest-value bit (MSB). After a complete data record has been transmitted, the SSI transducer holds the data signal at 0 until it is ready for a new transmission. The switching back of the data signal to 1 simultaneously satisfies the start condition for the SSI interface for triggering a new read-in cycle.

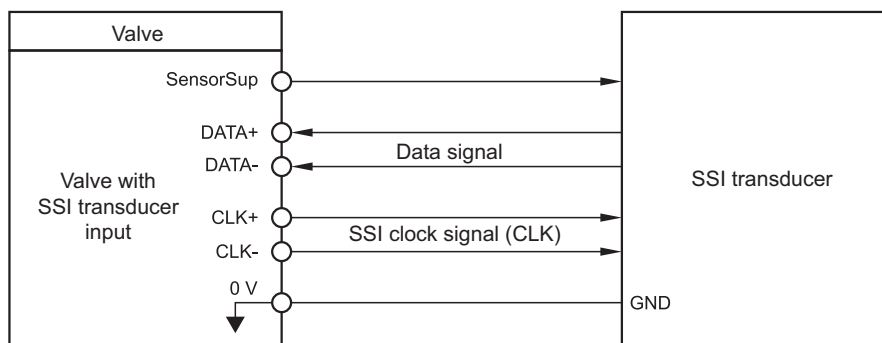

Wiring diagram with SSI transducer

Fig. 31: Wiring diagram with SSI transducer

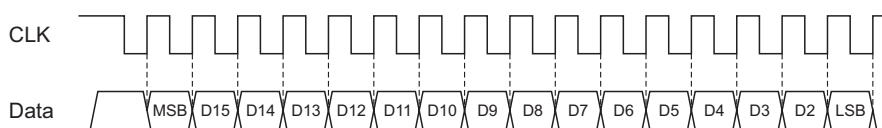

Signals between valve and a 16-bit SSI transducer (example)

Fig. 32: Signals between valve and a 16-bit SSI transducer (example)

The signal levels conform to the standard [EIA-422](#).

SSI transducers can be used with either Gray codes or binary coded data. A maximum of 32 bits is possible.



Detailed information can be found in the "Firmware" User Manual.

7.16 Wiring CAN networks

The valves are equipped with an electrically isolated CAN interface depending on the model. The CAN interface is supplied internally.

Procedure for connecting the valve to the CAN bus

Procedure

CAUTION

Danger of personal injury and damage to property!

Failure to heed safety instructions causes malfunctions and thus corresponding risks to people and equipment.

- ▶ Please heed all the safety instructions prior to and during start-up.

1. Establish the electrical connection to the CAN bus.
⇒ Chap. "7.8.1 CAN connectors", page 77
2. Set the module address.
⇒ Chap. "7.16.3 CAN module address (node ID)", page 110
3. Set the transmission rate.
⇒ Chap. "7.16.4 CAN transmission rate", page 110
4. Check the configuration of the valve software and the controller settings.

Observe the following points when wiring CAN networks:

- All cables, connectors and terminal resistors used in CAN networks should comply with ISO 11898.
- Correct version of protective grounding and electrical shielding.
⇒ Chap. "7.12 Protective grounding, equipotential bonding, and shielding", page 90
- Use shielded cables with four cores (twisted pair) and surge impedance of 120Ω (CAN_H, CAN_L, CAN_GND and CAN_SHLD grounded).
- A CAN bus cable must not branch but short stub cables with T-connectors are permitted.
- Stub cables must be as short as possible.
- Maximum stub cable length:
⇒ Chap. "7.16.1 Cable lengths and cable cross sections", page 109
- The cable between CAN_L and CAN_H at both CAN bus cable ends must be ended by a terminal resistor of $120 \Omega \pm 10 \%$.
- A terminal resistor can be omitted if the valve-internal terminal resistor (deactivated as standard) is activated (for configuration, see "Firmware" User Manual).
- Reference potential CAN_GND and CAN_SHLD may be connected to protective earth/ground (PE) at one point only (on a connector with terminal resistor, for example).
- The transmission rate must be adapted to the CAN bus cable length.
⇒ Chap. "7.16.1 Cable lengths and cable cross sections", page 109
- The maximum permissible number of CAN bus nodes in the CAN network must not be exceeded.

⇒ Chap. "7.16.2 Permissible number of CAN bus nodes", page 110

- Do not lay CAN Bus cables in the immediate vicinity of disturbance sources. If interference sources cannot be avoided, use double-shielded cables.

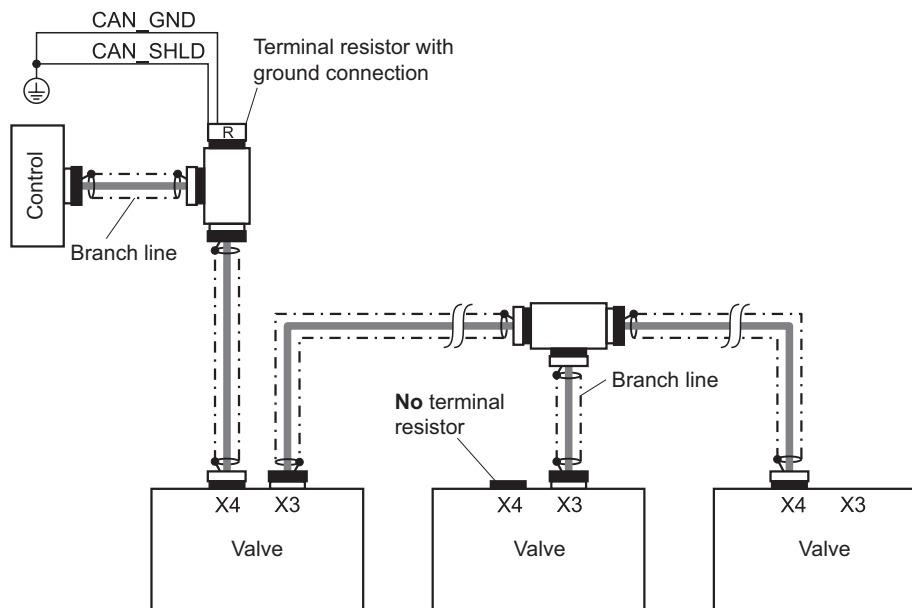

Wiring diagram of the CAN network

Fig. 33: CAN wiring diagram

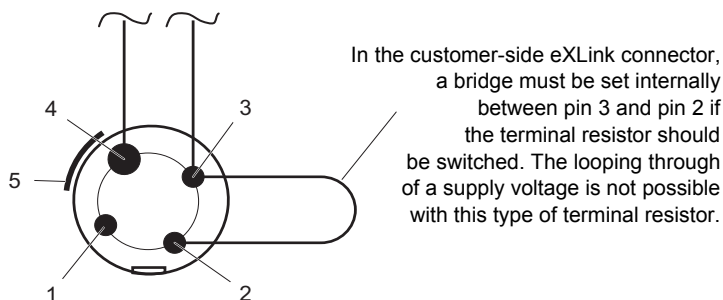

Customer-side connection of CAN bus to the valve if terminal resistor is required

Fig. 34: Connection of the CAN bus valve with terminal resistor



For CAN bus nodes without a galvanically isolated CAN bus interface, CAN_GND is generally connected to supply voltage GND inside the device.

In these cases, the supply voltage connection cable must be grounded at the same point inside the machine as the CAN_GND connection cable.

Maximum interference immunity is achieved in extensive CAN networks by using solely CAN bus nodes with galvanically isolated CAN bus interface.

If it is not possible to dispense with CAN bus nodes without galvanically isolated CAN bus interface, arrange these nodes in the immediate vicinity of the central ground point. The cable length to this central ground point is to be kept as short as possible. It is particularly important in this respect to ensure that the equipotential bonding line is properly dimensioned!

Interference immunity in CAN networks

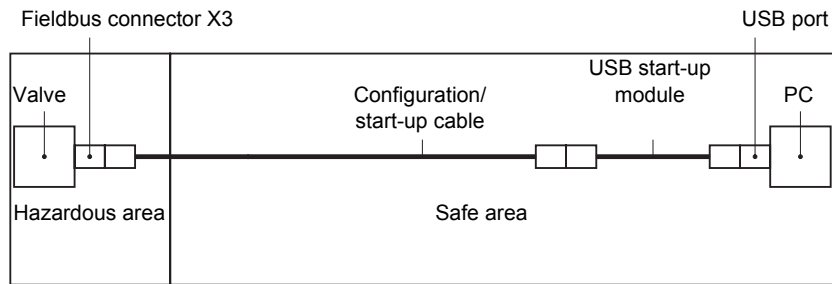

Connection of the valve to a PC via the CAN bus interface (X3)

Fig. 35: Connection of the valve to a PC via the CAN bus interface (fieldbus connector X3)

DANGER



Danger of explosion!

To guarantee safe operation in hazardous areas:

- ▶ In its standard model with screw plug, the service connector X10 is not permitted for use in hazardous areas.
- ▶ For mounting of the screw plug of the service connector X10, it must be observed that the gasket and the threads of the screw plug as well as the threads in the electronic housing of the valve are not damaged.
- ▶ In case of damage to the screw plug of the service connector or the threads in the electronic housing, the valve must not be operated in hazardous areas.
- ▶ Tightening torque screw plug:
⇒ [Chap. "3.1.2 Representative depiction of the valve", page 18](#)



The use of the service interface in the standard version is only permitted outside the hazardous area.

7.16.1 Cable lengths and cable cross sections

Transmission rate	Maximum cable length
1,000 kbit/s	25 m
800 kbit/s	50 m
500 kbit/s	100 m
250 kbit/s	250 m
125 kbit/s	500 m
100 kbit/s	650 m
50 kbit/s	1,000 m
20 kbit/s	2500 m

Cable lengths and cable cross sections

Tab. 15: Recommendation for maximum cable lengths in CAN networks, depending on the transmission rate

Cable cross section	Maximum cable length for n CAN bus nodes		
	n = 32	n = 64	n = 100
0.25 mm ²	200 m	170 m	150 m
0.50 mm ²	360 m	310 m	270 m
0.75 mm ²	550 m	470 m	410 m

Maximum cable length

Tab. 16: Recommendation for maximum cable lengths in CAN networks, depending on the cable cross section and the number n of CAN bus nodes

Transmission rate	Maximum stub cable length	
	Maximum	Cumulative
1,000 kbit/s	2 m	20 m
500 kbit/s	6 m	39 m
250 kbit/s	6 m	78 m
125 kbit/s	6 m	156 m

Maximum length of stub cables

Tab. 17: Maximum permissible stub cable lengths in CAN networks

7.16.1.1 Suitable cable types for CAN networks

Parameter	Value
Surge impedance	120 Ω

Suitable cable types for CAN networks

Tab. 18: Specification of electrical data for CAN bus cables

Manufacturer	Cable type
Web: http://www.drakamog.com	Draka ToughCAT7 Mud Protected

Tab. 19: Suitable cable types for CAN networks

7.16.2 Permissible number of CAN bus nodes

The CAN bus interface for the valve electronics supports integration in CAN networks with up to 110 CAN bus nodes.

However, the maximum permissible number of CAN bus nodes can be restricted by other nodes with an older CAN bus driver to 32.

A maximum of 127 nodes can be operated in a CAN network thanks to the use of repeaters. However, it is necessary to bear in mind here the additionally inserted signal propagation time, which limits the maximum expansion of the CAN network.

Maximum number of CAN bus nodes

7.16.3 CAN module address (node ID)

CAUTION



Danger due to malfunctions!

A multiple use of module addresses causes malfunctions and thus corresponding dangers to people and equipment.

- ▶ Each module address may only be used once within a CAN bus network.

CAN module address (node ID)

The factory setting for the module address of the valve electronics is 127.

The module address can be changed with the LSS services (Layer Setting Services) via the CAN bus.

If there are no additional nodes present on the CAN bus, it is possible to set the node ID via the LSS Service Switch Mode Global.

To change the module address of the valve electronics with a CAN bus network, it is essential to address the valve electronics unambiguously via the LSS address. The node ID is then set via the LSS Service Switch Mode Selective.

It is also possible to configure the module address via service interface X10.



The module address of the valve electronics can also be altered with the Moog Valve and Pump Configuration Software.

7.16.4 CAN transmission rate



The transmission rate must be set to the same value for all the CAN bus nodes within a CAN bus network.

CAN transmission rate

The factory setting for the transmission rate is 500 kbit/s.



The transmission rate can be changed with the LSS services (Layer Setting Services) via the CAN bus.



The transmission rate of the valves/pumps can also be altered with the Moog Valve and Pump Configuration Software.

7.17 Wiring Profibus-DP networks (X3, X4)

The valves are equipped with an electrically isolated Profibus-DP interface depending on the model. The Profibus-DP interface is supplied internally.

Wiring, Depending on the Model, of Profibus-DP Networks

Procedure for connecting the valves to the Profibus-DP

Procedure

CAUTION

Danger of personal injury and damage to property!

Failure to heed safety instructions causes malfunctions and thus corresponding risks to people and equipment.

- ▶ Please heed all the safety instructions prior to and during start-up.

1. Establish the electrical connection to the Profibus-DP.
⇒ [Chap. "7.8.2 Profibus-DP connectors", page 78](#)
2. Set the module address.
⇒ [Chap. "7.17.3 Profibus-DP module address \(node ID\)", page 113](#)
3. Check the configuration of the valve software and the controller settings.

Observe the following points when wiring Profibus-DP networks:

- It is recommended to use 2-core Profibus cables so as to prevent the power supply to the terminal resistors from being connected in parallel.
- The specification [EN 61158-2](#) describes two cable types. Type B can be used with limitation.
- Stub cables must be as short as possible.
- Avoid stub cables in the case of transmission rates in excess of 1,500 kbit/s.
- If stub cables are used, do not use any terminal resistors in this branch.
- The stub cable length in the case of transmission rates in excess of 1,500 kbit/s should not exceed 6.6 m in total.

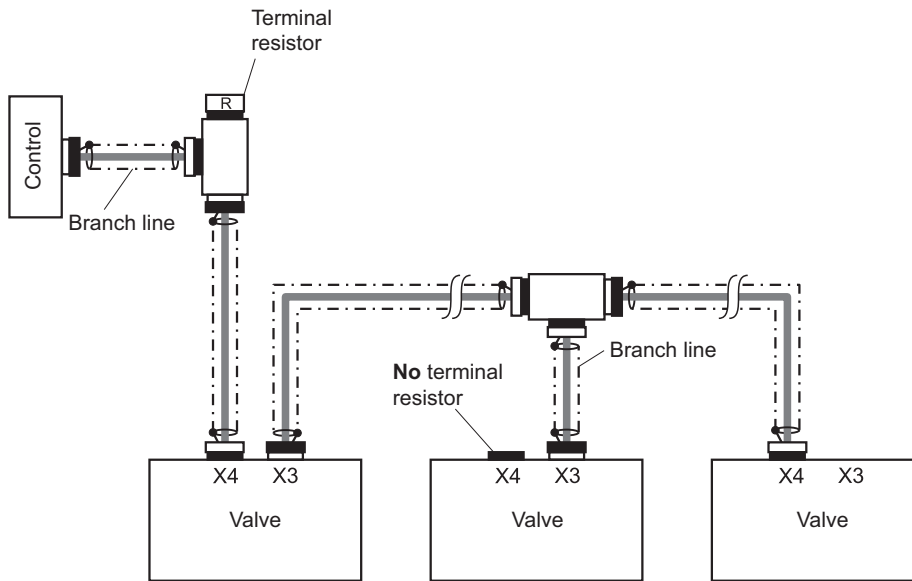

Wiring diagram of the Profibus-DP networks

Fig. 36: Profibus-DP wiring diagram

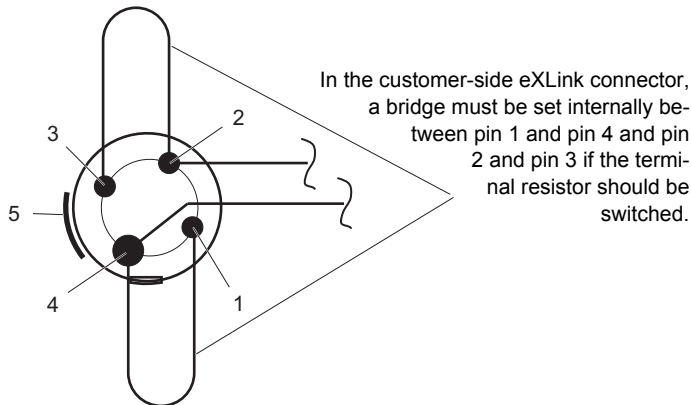

Customer-side connection of Profibus to the valve if terminal resistor is required

Fig. 37: Connection valve Profibus with terminal resistor

7.17.1 Cable lengths and cable cross sections

Transmission rate	Maximum cable length without repeaters
12,000 kbit/s	100 m
1,500 kbit/s	200 m
500 kbit/s	400 m
187.5 kbit/s	1,000 m
93.75 kbit/s	1,200 m
45.45 kbit/s	1,200 m
19.2 kbit/s	1,200 m
9.6 kbit/s	1,200 m

Cable lengths and cable cross sections

Tab. 20: Recommendation for maximum cable lengths in Profibus-DP networks, depending on the transmission rate

7.17.1.1 Suitable cable types for Profibus-DP networks

Parameter	Value
Characteristic cable impedance (Ω)	135 to 165 at 3 to 20 MHz
Effective capacitance (pF/m)	< 30
Loop impedance (Ω /km)	< 110
Cable diameter (mm)	> 0.64
Cable cross section (mm ²)	> 0.34

Tab. 21: Specification of electrical data for Profibus-DP cables (as per type A)

Suitable cable types for Profibus-DP networks

Manufacturer	Cable type
Web: http://www.drakamog.com	Draka ToughCAT7 Mud Protected

Tab. 22: Suitable cable types for Profibus-DP networks

7.17.2 Permissible number of Profibus nodes

The Profibus-DP interface of the valve electronics supports integration into Profibus-DP networks with up to 32 Profibus nodes.

A maximum of 126 nodes can be operated in a Profibus-DP network with the use of repeaters.

Permissible number of Profibus-DP nodes

7.17.3 Profibus-DP module address (node ID)

CAUTION



Danger due to malfunctions!

A multiple use of module addresses causes malfunctions and thus corresponding dangers to people and equipment.

- Each module address may only be used once within a Profibus DP network.

Profibus-DP module address (node ID)

The module address can be configured by sending a Set_Slave_Add telegram from a controller. There is also the option of configuring the module address by writing to the Profibus module identifier.

It is also possible to configure the module address via service interface X10.

The factory setting for the module address of the valve electronics is 126.



The module address of the valve electronics can also be altered with the Moog Valve and Pump Configuration Software.

7.17.4 Profibus-DP transmission rate

The valve electronics are automatically set to the transmission rate specified by the Profibus master. It is not possible, nor is it necessary, to configure the transmission rate on the slave side.

Profibus-DP transmission rate

7.18 Wiring EtherCAT networks (X3, X4)

The valves are equipped with an electrically isolated EtherCAT interface depending on the model. The EtherCAT interface is supplied internally.

Wiring EtherCAT networks

Procedure for connecting the valves to the EtherCAT bus

Procedure

CAUTION

Danger of personal injury and damage to property!

Failure to heed safety instructions causes malfunctions and thus corresponding risks to people and equipment.

- ▶ Please heed all the safety instructions prior to and during start-up.

1. Establish the electrical connection to the EtherCAT bus.
⇒ [Chap. "7.8.3 EtherCAT connectors", page 80](#)
2. Optional: Set the module address.
⇒ [Chap. "7.18.3 EtherCAT module address \(node ID\)", page 116](#)
3. Check the configuration of the valve software and the controller settings, in particular the command signal source.



Detailed information can be found in the "Firmware" User Manual.

Observe the following points when wiring EtherCAT networks:

- All cables must be designed as shielded cables with twisted-pair litz wires as per [ISO/IEC 8802-3 100 Base-TX](#) and CAT 5 as per [ANSI/TIA/EIA-568-B.1](#).
- The cable length between two nodes must not exceed 100 m as per [ISO/IEC 8802-3 100 Base-TX](#).
- The maximum permissible number of EtherCAT nodes must not exceed 65,536.
- The cable between the nodes must not branch.
- An external cable termination (terminal resistor) as in CAN or Profibus-DP networks is not necessary.

Wiring diagram of the EtherCAT network

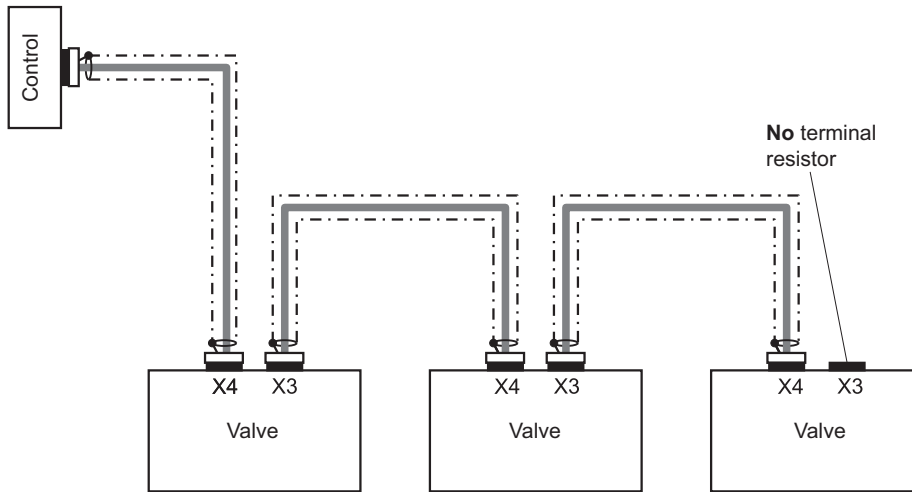

Fig. 38: EtherCAT wiring diagram

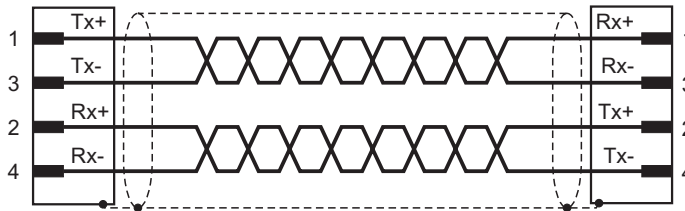

Fig. 39: Twisted-pair litz wires in Ethernet/EtherCAT cables with M12 connectors

Pin assignment for the EtherCAT cable

An RJ45 connector is usually used on the controller side. The colors of the litz wires are standardized in accordance with [IEEE 802.3](#) for Ethernet.

Signal	X3, X4	Litz wire	RJ45	Litz wire (RJ45, 4-core cable)
TX+	1	orange	1	orange/white (yellow/white)
RX+	2	blue	3	green/white
TX-	3	white (shielded with orange)	2	orange
RX-	4	white (shielded with blue)	6	green
Shield	Housing			

Tab. 23: Assignment of Ethernet/EtherCAT signals with mixed connector types

7.18.1 Suitable cable types for EtherCAT networks

CAT 5 cable according to [ANSI/TIA/EIA-568-B.1](#). e.g. Draka ToghCAT7 Mud Protected

Suitable cable types for EtherCAT networks

7.18.2 Permissible number of EtherCAT nodes

The EtherCAT interface of the valve electronics supports integration into EtherCAT networks with up to 65,535 EtherCAT nodes.

The maximum number of nodes in a fieldbus line is 216.

The number of nodes determines the signal propagation time of the data packets and the resulting possible cycle times.

Permissible number of EtherCAT nodes

7.18.3 EtherCAT module address (node ID)

CAUTION



Danger due to malfunctions!

A multiple use of module addresses causes malfunctions and thus corresponding dangers to people and equipment.

- ▶ Each module address may only be used once within an EtherCAT network.

EtherCAT module address (node ID)

EtherCAT nodes can be addressed using the physical position within the network. This procedure is known as auto-increment addressing.

If position-independent addressing is preferred, a static module address can also be allocated. This addressing type is known as fixed node addressing.

Auto-increment addressing

Each EtherCAT node is identified using the physical position within the network segment. For this purpose, each EtherCAT node increments a 16-bit address field within a telegram, which is sent through the entire network. The advantage of this mechanism lies in the fact that no module address has to be set manually for the fieldbus nodes.

Fixed node addressing

With fixed node addressing a node is addressed via the so-called Configured Station Alias. This address can be configured by the network master in the Slave Information Interface (SII).

There is also the option of configuring the module address by writing to the EtherCAT module identifier.

The advantage of fixed node addressing over auto-increment addressing lies in the fact that the nodes can still be addressed at the same address even after the network topology has been changed or after nodes have been added or removed.

The factory setting for the module address of the valve electronics is 0.

It is also possible to configure the module address via service interface X10.



The module address of the valve electronics can also be altered with the Moog Valve and Pump Configuration Software.

7.18.4 EtherCAT transmission rate

EtherCAT works with a fixed transmission rate of 100 Mbit/s.

EtherCAT-DP transmission rate

7.19 Wiring analog inputs (X5, X6, X7)

The signal connectors X5, X6, and X7 are wired the same in the valve. On pin 1, a supply voltage of 24 V DC is made available by the valve in order to supply sensors.

Maximum current of transducer supply



There is joint fusing of this power supply for X2, X5, X6 and X7. The entire supply current may not exceed the following value:
 $I_{\max} (X2+X5+X6+X7) = 300 \text{ mA}$

An external power supply to the transducer is also possible. However, the 0 V transducer supply must be connected to supply zero. An interruption of the transducer supply current can be identified as a cable break (see "Firmware" User Manual).

The supply voltage is cut off in the event of a possible short circuit in the supply voltage to the transducer. A fault reaction can be configured (see "Firmware" User Manual). The voltage is available again as soon as the short circuit has been eliminated.

The supply current for each transducer is monitored for the purpose of detecting cable breaks. Supply currents under 1 mA can trigger a configurable fault reaction.

2/3/4-wire transducers with a voltage or current output can be connected to X5, X6 and X7. Each input can be individually adapted.

2-wire transducers

2-wire transducers can only be operated in the signal type for the 0–10 mA or 4–20 mA analog input in the single-ended version.

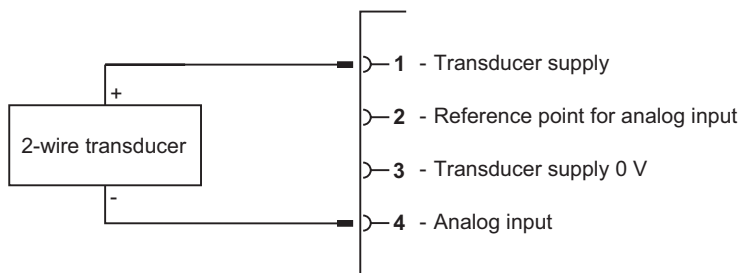

Wiring the 2-wire transducer

Fig. 40: Connecting a 2-wire transducer to analog input connectors X5, X6 or X7

3-wire transducers

3-wire transducers can only be operated in the single-ended version.

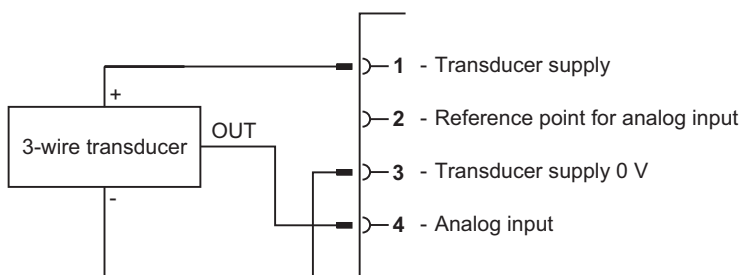

Wiring the 3-wire transducer

Fig. 41: Connecting a 3-wire transducer to analog input connectors X5, X6 or X7

4-wire transducers

4-wire transducers should be operated in the differential version.

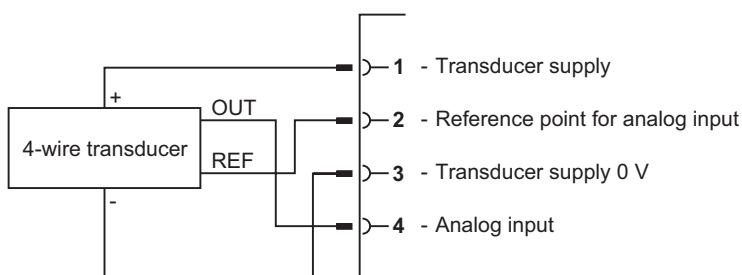

Wiring the 4-wire transducer

Fig. 42: Connecting a 4-wire transducer to analog input connectors X5, X6 or X7

7.20 Electrical start-up

DANGER



Danger of explosion!

An explosion can be triggered by sparks when switching on the machine.

- ▶ Open connectors for the interface must absolutely be covered before start-up.
- ▶ The eXLink connectors from CEAG must be mounted according to the instructions in the operating instructions for the eXLink connectors.
- ▶ In the standard model with a screw plug, the service connector X10 is not permitted for use in hazardous areas.
- ▶ The service connector X10 in the standard model M8, 3-pin must be sealed with the original screw plug belonging to the valve before start-up.
- ▶ When mounting the screw plug for the service connector X10, it must be observed that the gasket and the thread of the screw plug as well as the thread in the electronic housing of the valve are not damaged.
- ▶ In case of damage to the screw plug for the service connector X10 or the threads in the electronic housing, the valve must not be operated.
- ▶ Tightening torque for screw plug:
⇒ [Chap. "3.1.2 Representative depiction of the valve", page 18](#)

WARNING



Danger of explosion!

To guarantee safe operation in hazardous areas:

- ▶ The signal interfaces of the valve are implemented with explosion-proof connectors.
- ▶ For mounting and removal of the connectors as well as operation of the valve, the notes and instructions in the "Explosion-proof connectors eXLink, CEAG" operating instructions must absolutely be adhered to.

WARNING



Danger of explosion!

For electrical start-up, cables on the valve, cable glands, screw plugs, and connectors must not be damaged.

- ▶ The valve must not be started up with damaged cables, plug connectors, and screw plugs, and it must be sent to us or to one of our authorized service centers immediately.



For the standard model of the valve, the service interface is not suitable for use in hazardous areas. On request, the service interface is available in an explosion-proof model.

7.21 Electromagnetic compatibility (EMC)

The machine manufacturer is responsible for complying with the EMC Directive.

EMC requirements

The valves fulfill the EMC protective requirements for immunity to interference as per [EN 61000-6-2](#) (assessment criterion A) and for interference emissions according to [EN 61000-6-4](#)

The following technical requirements must be in place so that the EMC protection requirements can be satisfied:

- Use of the mating connectors recommended for the valves.
⇒ [Chap. "12.1 Accessories for valves in the D67XK series", page 222](#)
- Adequate shielding.
- Correct execution of equipotential bonding system, protective grounding and electrical shielding.
⇒ [Chap. "7.12 Protective grounding, equipotential bonding, and shielding", page 90](#)

7.22 Communication via the Moog Valve and Pump Configuration Software

CAUTION

**Danger of personal injury and damage to property!**

Improper handling of the Moog Valve and Pump Configuration Software causes malfunctions and thus corresponding risks to people and equipment.

- ▶ For safety reasons, the Moog Valve and Pump Configuration Software must not be used inside a machine for visualization purposes or as an operator terminal.

CAUTION

**Danger of personal injury and damage to property!**

It is not permitted to operate the Moog Valve and Pump Configuration Software on a fieldbus while the machine is running.

It is only permitted to activate valves via the Moog Valve and Pump Configuration Software if this does not cause any dangerous states in the machine and in its surroundings.

CAUTION

**Danger of personal injury and damage to property!**

Activating valves via the Moog Valve and Pump Configuration Software within a network can give rise to unforeseeable events if fieldbus communication takes place simultaneously between the machine control or other bus nodes!

- ▶ Deactivate the fieldbus communication for machine control and other bus nodes.

CAUTION

**Danger of personal injury and damage to property!**

Messages from the Moog Valve and Pump Configuration Software can also be received by other bus nodes. This may trigger unforeseeable events.

- ▶ Deactivate the fieldbus communication for machine control and other bus nodes.

CAUTION

**Danger of personal injury and damage to property!**

If danger-free operation of the valves via the Moog Valve and Pump Configuration Software can also not be ensured with deactivated fieldbus communication to the machine control and other bus nodes, the following must be heeded:

- ▶ The valves may only communicate depressurized and in a direct connection (point-to-point) with the Moog Valve and Pump Configuration Software.

CAUTION**Data loss!**

Data communication between the valve electronics and the Moog Valve and Pump Configuration Software may be disrupted if other fieldbus nodes (e.g. a controller) are accessing the valve electronics at the same time.

- ▶ Deactivate the fieldbus communication for machine control.

The Moog Valve and Pump Configuration Software communicates with the valves via the CAN interface. The CAN bus interface is either on the service interface X10 or available on the CAN fieldbus interface -X3 and X4.

If the Moog Valve and Pump Configuration Software is operated within a CAN network with fieldbus communication of the machine running, the following faults can occur:

- Data exchange with the valve may be disrupted if another device (such as a controller) accesses the valve simultaneously.
- Node guarding may be activated only if no other fieldbus node is monitoring the valves via this service.
- Fieldbus telegrams can also be received by other fieldbus nodes. This may trigger off unforeseeable events!

To establish a direct connection between Moog Valve and Pump Configuration Software and valve, detach the fieldbus cable from the valve and connect the valve directly to the USB CAN interface of the service PC. A $120 \Omega \pm 10 \%$ terminal resistor is required here.

The configuration/start-up cable not included in the scope of delivery already features a terminal resistor.

This configuration/start-up cable can only be used outside of hazardous areas. The cable can only be used in connection with the M8-M12 adapter and thus only on the service connector X10.

⇒ [Chap. "12.1 Accessories for valves in the D67XK series", page 222](#)

Operation of the Moog Valve and Pump Configuration Software**Possible faults**

8 Start-up

DANGER



Danger to life!

Operating machines with damaged or defective components or with a leaking hydraulic system is dangerous and not permitted.

- ▶ Before starting up or operating the valve, check the higher-level machine including all its installed components for damage and defects.
- ▶ Pay particular attention here to higher-level and hydraulic safety devices such as, for example, EMERGENCY STOP switches and pressure-limiting valves.
- ▶ Report damage or defects to the relevant department immediately. If necessary, stop the machine immediately and secure it.
- ▶ Rectify any leaks immediately in accordance with this user manual, paying particular attention to the notes/instructions on handling in accordance with safety requirements.
- ▶ ⇒ Chap. "2.1 Handling in accordance with safety requirements", page 14
- ▶ ⇒ Chap. "10.3 Troubleshooting", page 147

Safety instructions:
Start-up

DANGER



Danger of explosion!

To guarantee safe operation in hazardous areas:

- ▶ In its standard model with screw plug, the service connector X10 is not permitted for use in hazardous areas.
- ▶ For mounting of the screw plug of the service connector X10, it must be observed that the gasket and the threads of the screw plug as well as the threads in the electronic housing of the valve are not damaged.
- ▶ In case of damage to the screw plug of the service connector or the threads in the electronic housing, the valve must not be operated in hazardous areas.
- ▶ Tightening torque screw plug:
⇒ Chap. "3.1.2 Representative depiction of the valve", page 18

DANGER



Danger of explosion!

To guarantee safe operation in hazardous areas:

- ▶ The signal interfaces of the valve are implemented with explosion-proof connectors.
- ▶ For mounting and removal of the connectors as well as operation of the valve, the notes and instructions in the "Explosion-proof connectors eXLink, CEAG" operating instructions must absolutely be adhered to.
- ▶ The eXLink operating instructions from CEAG are in the Appendix to this user manual.

DANGER**Danger of poisoning and injury due to hydraulic fluid squirting out under pressure!**

Contact with hydraulic fluids can damage your health (e.g. eye injuries, skin and tissue damage, poisoning in case of inhaling).

- ▶ Wear protective gloves and safety glasses.
- ▶ If hydraulic fluid gets into your eyes or on your skin, consult a doctor immediately.
- ▶ When handling hydraulic fluids, observe the safety provisions applicable to the hydraulic fluid used.

DANGER**Danger of injury due to electric voltage and unexpected movements!**

Work on machines that are not shut down presents a danger to life and limb. Work such as mounting or removal, electrical or hydraulic connection, troubleshooting or service may only be performed on machines and valves that are shut down.

- ▶ Make sure to shut the machine down and switch it off.
- ▶ Make sure that the drive motor cannot be switched on.
- ▶ For this purpose, switch off the supply voltage as well as that of connected peripherals, such as externally powered transducers or programming units.
- ▶ Make sure that all power-transmitting components and connections (electrical and hydraulic) are switched off according to the manufacturer's instructions and secured against switching on again. If possible, remove the main fuse from the machine.
- ▶ Make sure that the machine is completely depressurized.

DANGER**Danger of explosion!**

Open connectors for the interface must absolutely be covered before start-up.

- ▶ The interfaces must be sealed with the original screw plug belonging to the valve.

DANGER**Danger of explosion!**

The unsafe operation of the valves is dangerous.

- ▶ Only operate the valve when it is in a safe and functional state.
- ▶ At least once per shift, check valve for damage visible from the outside and defects such as leakage or damaged cables or connectors.
- ▶ The cable glands must be checked at regularly-prescribed intervals. For details, see standard EN 60079-17.
- ▶ Report changes, including to the operating behavior, damage, and defects to the responsible department immediately. If necessary, stop the machine immediately and secure it.
- ▶ ⇒ [Chap. "2.1 Handling in accordance with safety requirements", page 14](#)
- ▶ ⇒ [Chap. "10.3 Troubleshooting", page 147](#)

DANGER**Danger of explosion!**

An explosion can be triggered by sparks when switching on the machine.

- ▶ Open connectors for the interface must absolutely be covered before start-up.
- ▶ The eXLink connectors from CEAG must be mounted according to the instructions in the operating instructions for the eXLink connectors.
- ▶ In the standard model with a screw plug, the service connector X10 is not permitted for use in hazardous areas.
- ▶ The service connector X10 in the standard model M8, 3-pin must be sealed with the original screw plug belonging to the valve before start-up.
- ▶ When mounting the screw plug for the service connector X10, it must be observed that the gasket and the thread of the screw plug as well as the thread in the electronic housing of the valve are not damaged.
- ▶ In case of damage to the screw plug for the service connector X10 or the threads in the electronic housing, the valve must not be operated.
- ▶ Tightening torque for screw plug:
⇒ [Chap. "3.1.2 Representative depiction of the valve", page 18](#)

WARNING**Danger of explosion!**

For electrical start-up, cables on the valve, cable glands, screw plugs, and connectors must not be damaged.

- ▶ The valve must not be started up with damaged cables, plug connectors, and screw plugs, and it must be sent to us or to one of our authorized service centers immediately.

WARNING**Danger of personal injury and damage to property!**

The operation of the valves at pressure that is too high on the hydraulic connections can cause injuries and damage to the machine.

- ▶ Pressure-limiting valves or other comparable safety devices, for example, must be installed to limit the pressure at all the hydraulic ports to the specified maximum operating pressure. Maximum operating pressure:
⇒ [Chap. "11 Technical Data", page 152](#)

WARNING**Risk of injury!**

To provide protection against injuries or other damaging influences on health, suitable protective measures must be taken if necessary prior to and when carrying out any work on the valves or the machine, such as mounting or removing, electrical or hydraulic connection, troubleshooting or servicing, and when handling the valves, accessories, tools or hydraulic fluids.

- ▶ ⇒ [Chap. "2.2 Occupational safety and health", page 15](#)

CAUTION**Danger of personal injury and damage to property!**

By changing the configuration of the valves, the functionality of the valve can be changed so that it causes damage, malfunction or failure of the valve or machine.

- ▶ It is only permitted to alter the valve configuration during operation if this does not cause any dangerous states in the machine and in its surroundings.

CAUTION**Danger of personal injury and damage to property!**

Working with and on the valves without the required basic mechanical, hydraulic, and electrical knowledge may cause injuries or parts may be damaged.

- ▶ Only properly qualified and authorized users may work with and on the valves.
- ▶ ⇒ [Chap. "1.4 Selection and qualification of personnel", page 7](#)

CAUTION**Risk of damage due to dirt and moisture!**

This is the only way of adequately protecting the valves against the penetration of dirt and moisture and protecting the gaskets/seals against the effects of ozone and UV.

- ▶ The valves must not be transported or stored without their shipping plate fitted.
- ▶ The valve shipping plate may only be removed from the valve hydraulic ports directly prior to mounting and must be reinstalled directly after the valve has been removed.
- ▶ The shipping plate and the associated attachment elements (screws and nuts) must be kept for later use, e.g. during transportation.

8.1 Preparations

The valves may only be started up when the following is ensured:

- The higher-level machine with all its installed components complies with the latest versions of the relevant national and international regulations, standards and guidelines (such as, for example, the EU Machinery Directive, the regulations of the trade association and of TÜV or VDE).
- The valves and all the other installed components are in a technically fault-free and operationally reliable state.
- No signals that can lead to uncontrolled movements in the machine are transmitted to the valves.

⇒ [Chap. "1.3 Intended operation", page 5](#)

Preparations for start-up

8.2 Start-up of the valves

Procedure:

1. Make sure that all the machine components, connections and ports conform to the specifications of the machine manufacturer and operator.
2. Prepare the hydraulic system.
⇒ Chap. "8.4 Filling and flushing the hydraulic system", page 132
3. Establish the valve hydraulic connection.
⇒ Chap. "6.3 Mounting the valve", page 58
4. Establish the valve electrical connection.
⇒ Chap. "7.11 General notes on wiring", page 88
5. Valves with fieldbus interface:
Connect the valve to the fieldbus.
6. Make sure that all the mechanical and electrical connections and hydraulic ports are correctly established. The eXLink operating instructions from CEAG are in the Appendix to this user manual.
7. Make sure that the valve is correctly configured, or carry out configuration.
⇒ Chap. "3.5 Configuration software", page 47
⇒ Chap. "8.3 Configuration of the valves", page 128
8. Start-up of the hydraulic system.
⇒ Chap. "8.5 Start-up of the hydraulic system", page 133
9. If necessary, correct the zero position parameters in the valve software. The parameters can be set or interrogated via the service or field bus interface in the valve software. Setting and interrogation can be performed for example with the Moog Valve and Pump Configuration Software.
For additional information, see User Manual Firmware.

Procedure for Start-up

8.3 Configuration of the valves

CAUTION



Danger of personal injury and damage to property!

By changing the configuration of the valves, the functionality of the valve can be changed so that it causes damage, malfunction or failure of the valve or machine.

- ▶ It is only permitted to alter the valve configuration during operation if this does not cause any dangerous states in the machine and in its surroundings.

**Safety instructions:
configuration of
the valves**

CAUTION



Danger of personal injury and damage to property!

The selected settings must be documented after the configuration of the valves has been altered.

The settings can be documented for example with the Moog Valve and Pump Configuration Software.

- ▶ After a valve has been repaired or replaced, the user must transfer the settings again to the repaired or new valve because repaired or replacement valves are like new valves delivered with factory settings.
- ▶ ⇒ [Chap. "8.3.3 Factory setting of the valves", page 131](#)
- ▶ ⇒ [Chap. "10.4 Repair", page 150](#)

The Moog Valve and Pump Configuration Software is available as an accessory to simplify start-up, diagnosis and configuration of the valves.

⇒ [Chap. "3.6 Moog Valve and Pump Configuration Software", page 48](#)

8.3.1 Configuration via the fieldbus interface

Valves with field bus interfaces are started up, activated, monitored and configured via the field bus interface (connectors X3 and X4).

**Configuration of
the valves via the
fieldbus interface**

8.3.1.1 Configuration with the machine controller

To be able to configure the valves with the machine controller, it is necessary to connect the valve to the machine controller via the fieldbus.

**Configuration with
the machine controller**

8.3.1.2 Configuration with the Moog Valve and Pump Configuration Software

The Moog Valve and Pump Configuration Software communicates with the valves via the CAN interface. The CAN bus interface is either on the service interface X10 or available on the CAN fieldbus interface -X3 and X4.

⇒ [Chap. "7.22 Communication via the Moog Valve and Pump Configuration Software"](#), page 121

8.3.2 Configuration via the service interface

DANGER



Danger of explosion!

To guarantee safe operation in hazardous areas:

- ▶ In its standard model with screw plug, the service connector X10 is not permitted for use in hazardous areas.
- ▶ For mounting of the screw plug of the service connector X10, it must be observed that the gasket and the threads of the screw plug as well as the threads in the electronic housing of the valve are not damaged.
- ▶ In case of damage to the screw plug of the service connector or the threads in the electronic housing, the valve must not be operated in hazardous areas.
- ▶ Tightening torque screw plug:
 - ⇒ [Chap. "3.1.2 Representative depiction of the valve", page 18](#)



For the standard model of the valve, the service interface is not suitable for use in hazardous areas. On request, the service interface is available in an explosion-proof model.

Valves without CAN bus interfaces can be started up and configured via the service interface (service connector-X10) with the Moog Valve and Pump Configuration Software.

⇒ [Chap. "3.6 Moog Valve and Pump Configuration Software", page 48](#)

The following are required to be able to configure the valves with the Moog Valve and Pump Configuration Software via the service interface (service connector X10):

- USB start-up module, not approved for use in hazardous areas
- Configuration/start-up cable
- Adapter for service connector X10, not approved for use in hazardous areas
- PC with installed Moog Valve and Pump Configuration Software



USB start-up module, configuration/starting-up cable, adapter and Moog Valve and Pump Configuration Software are available as accessories.

⇒ [Chap. "12.1 Accessories for valves in the D67XK series", page 222](#)

To be able to configure the valves via the service interface, it is necessary to connect the valve as follows to the PC with installed Moog Valve and Pump Configuration Software:

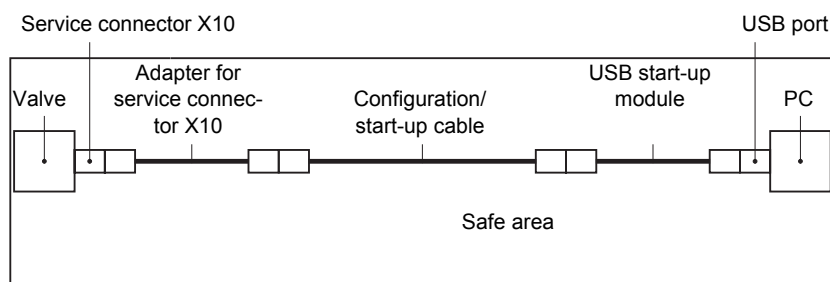

Fig. 43: Connection of the valve to a PC via the service interface (service connector X10)

Configuration of the valves via the service interface

Connection of the valve to a PC via the service interface (X10)

8.3.3 Factory setting of the valves

The valve is delivered from the factory with preset parameters. This presetting corresponds to the factory setting of the valves.

Depending on the valve type and model, it may be necessary to adapt the parameters to the respective application.

If the valve is to be incorporated in a fieldbus, it may also be necessary to adapt the communication parameters.

Factory setting of the valves



Please contact Moog or one of its authorized service centers for information on the factory setting parameters.

8.3.4 Storing of parameters

Modified parameters are initially stored in the volatile memory of the valve electronics microprocessor system, i.e. they are lost if the power supply is interrupted. When the power supply is restored, the parameters that were stored last are again available.

Volatile memory

The microprocessor system also has a non-volatile memory. In order to store the modified parameters in this memory, it is necessary to send a memory command to the valve. If the power supply is interrupted, the modified valve configuration will again be available after the supply is restored.

Non-volatile memory

8.4 Filling and flushing the hydraulic system

WARNING



Risk of injury!

In order to prevent injuries and other damage to health when flushing the hydraulic system, please observe the following notes.

- ▶ The manufacturer and operator of the machine are responsible for making sure that for safety-critical use, relevant safety standards in the latest version, which serve to avoid damage, are heeded.
- ▶ It is vital among other things to ensure that both the individual components and the complete machine can be rendered in a safe state.
- ▶ If a switching valve is fitted to flush the hydraulic system, this must not cause any potentially dangerous states in the machine.

Procedure:

1. Depressurize the hydraulic system.
2. Fill the hydraulic system in accordance with the instructions of the manufacturer and the operator of the machine.
Because new hydraulic fluid is unfiltered, the hydraulic system must be filled via a filling filter with a filter fineness of at least $\beta_{10} \geq 75$ (10 μm absolute).
3. Replace existing filter elements with flushing elements in accordance with the instructions of the manufacturer and the operator of the machine.
4. Remove the proportional valve.
⇒ [Chap. "10.1 Removing of the valves", page 143](#)
5. Instead of the proportional valve, you must install a flushing plate or, if allowed by the hydraulic system, a switching valve.



Use the flushing plate to flush lines P and T.
The switching valve can also be used to flush the actuator with lines A and B.



The flushing plates are not included in the valve scope of delivery.
They are available as an accessory.
⇒ [Chap. "12.1 Accessories for valves in the D67XK series", page 222](#)

Procedure for filling and flushing the hydraulic system

6. Carefully flush the hydraulic system in accordance with the instructions of the manufacturer and the operator of the machine. Observe the following when doing so:

- In order to obtain the best possible flushing effect, make sure the hydraulic fluid reaches operating temperature.
- Observe the minimum flushing time t:

$$t = 5 \cdot \frac{V}{Q} \quad [\text{h}]$$

V [l] : Tank capacity

Q [l/min] : Pump delivery

- End the flushing process when at least the cleanliness level as specified in [ISO 4406](#) is achieved.
18/15/12

7. Depressurize the hydraulic system.

8. Replace flushing elements with suitable filter elements in accordance with the instructions of the manufacturer and the operator of the machine.

9. Remove the flushing plate or switching valve.

10. Mount the proportional valve.

⇒ [Chap. "6.3 Mounting the valve"](#), page 58

8.5 Start-up of the hydraulic system

Procedure:

1. Start-up the hydraulic system in accordance with the instructions of the manufacturer and the operator of the machine.
2. Vent the hydraulic system in accordance with the instructions of the manufacturer and the operator of the machine.
3. Check the hydraulic system for external leaks.

Procedure for start-up of the hydraulic system

8.5.1 Venting the actuator

CAUTION

Risk of damage!

Air trapped in the hydraulic system, particularly in the case of high pressure peaks in the system, can cause a diesel effect. If the trapped air bubbles are compressed very quickly and thus heated, this can cause the mixture to self-ignite. This gives rise to a very high increase in pressure and temperature locally, which in turn can result in damage in the hydraulic system, e.g. to gaskets or components, causing the oil to age more quickly.

- ▶ In order to avoid diesel effects, the hydraulic system must be ventilated.

9 Operation

Safety instructions:
Operation

DANGER



Danger to life!

Operating machines with damaged or defective components or with a leaking hydraulic system is dangerous and not permitted.

- ▶ Before starting up or operating the valve, check the higher-level machine including all its installed components for damage and defects.
- ▶ Pay particular attention here to higher-level and hydraulic safety devices such as, for example, EMERGENCY STOP switches and pressure-limiting valves.
- ▶ Report damage or defects to the relevant department immediately. If necessary, stop the machine immediately and secure it.
- ▶ Rectify any leaks immediately in accordance with this user manual, paying particular attention to the notes/instructions on handling in accordance with safety requirements.
- ▶ ⇒ Chap. "2.1 Handling in accordance with safety requirements", page 14
- ▶ ⇒ Chap. "10.3 Troubleshooting", page 147

DANGER



Danger of personal injury and damage to property!

Failure to heed the eXLink operating instructions from CEAG can cause bodily injuries and property damage.

- ▶ Follow the eXLink operating instructions from CEAG in the Appendix to this user manual.
- ▶ Handle all ex-proof connectors according to the notes and instructions in the eXLink operating instructions from CEAG

DANGER



Danger of injury due to electric voltage and unexpected movements!

Work on machines that are not shut down presents a danger to life and limb. Work such as mounting or removal, electrical or hydraulic connection, troubleshooting or service may only be performed on machines and valves that are shut down.

- ▶ Make sure to shut the machine down and switch it off.
- ▶ Make sure that the drive motor cannot be switched on.
- ▶ For this purpose, switch off the supply voltage as well as that of connected peripherals, such as externally powered transducers or programming units.
- ▶ Make sure that all power-transmitting components and connections (electrical and hydraulic) are switched off according to the manufacturer's instructions and secured against switching on again. If possible, remove the main fuse from the machine.
- ▶ Make sure that the machine is completely depressurized.

DANGER**Danger of explosion!**

The unsafe operation of the valves is dangerous.

- ▶ Only operate the valve when it is in a safe and functional state.
- ▶ At least once per shift, check valve for damage visible from the outside and defects such as leakage or damaged cables or connectors.
- ▶ The cable glands must be checked at regularly-prescribed intervals. For details, see standard EN 60079-17.
- ▶ Report changes, including to the operating behavior, damage, and defects to the responsible department immediately. If necessary, stop the machine immediately and secure it.
- ▶ ⇒ Chap. "2.1 Handling in accordance with safety requirements", page 14
- ▶ ⇒ Chap. "10.3 Troubleshooting", page 147

DANGER**Danger of explosion!**

The unsafe operation of the valves is dangerous and not permitted.

- ▶ Open connectors for the interfaces are not permitted and must absolutely be covered before start-up.
- ▶ The eXLink connectors from CEAG must be mounted correctly according to the instructions in the "Ex plug connector eXLink" operating instructions. Here the instructions and notes in the operating instructions for the connectors must be heeded.
- ▶ Only use the service connector X10 in the M8 mode., 3-pin outside the hazardous areas.
- ▶ The service connector X10 in the standard model M8, 3-pin must be sealed with the original screw plug belonging to the valve before start-up.
- ▶ For a configuration of the valve within hazardous areas, on request there is the X10 interface with an appropriate Ex-protected plug connector.

DANGER**Danger of explosion due to impermissible heating up of the valve!**

As a result of insufficient ventilation of the valve or deposits on the valve, the impermissible heating up of the valve can be such that the maximum temperatures of the certified temperature classes are exceeded.

- ▶ The valves must be checked regularly, cleaned if necessary. Deposits on the valve must be removed.
- ▶ If necessary inform the responsible person immediately and remove the valve from electrical and hydraulic operation.

WARNING**Danger of explosion!**

During operation, cables on the valve, cable glands, screw plugs, and connectors must not be damaged.

- ▶ The valve must not be started up with damaged cables, connectors, and screw plugs, and it must be sent to us or to one of our authorized service centers immediately.

WARNING**Risk of injury!**

To provide protection against injuries or other damaging influences on health, suitable protective measures must be taken if necessary prior to and when carrying out any work on the valves or the machine, such as mounting or removing, electrical or hydraulic connection, troubleshooting or servicing, and when handling the valves, accessories, tools or hydraulic fluids.

- ▶ ⇒ [Chap. "2.2 Occupational safety and health", page 15](#)

CAUTION**Danger of personal injury and damage to property!**

In addition, to avoid damage or leaks, perform the following tasks at regular intervals in accordance with the instructions of the manufacturer and the operator of the machine:

- ▶ Checking the valve and the hydraulic system for externally identifiable damage and defects.
- ▶ Checking for loose plugs/connectors.
- ▶ Checking the cleanliness level of the hydraulic fluid.
- ▶ Checking the port O-rings for elasticity, integrity and correct seating.
- ▶ ⇒ [Chap. "10.2.1 Checking and replacing the port O-rings", page 146](#)

CAUTION**Danger of personal injury and damage to property!**

By changing the configuration of the valves, the functionality of the valve can be changed so that it causes damage, malfunction or failure of the valve or machine.

- ▶ It is only permitted to alter the valve configuration during operation if this does not cause any dangerous states in the machine and in its surroundings.

CAUTION**Danger of personal injury and damage to property!**

It is not permitted to operate the Moog Valve and Pump Configuration Software on a fieldbus while the machine is running.

It is only permitted to activate valves via the Moog Valve and Pump Configuration Software if this does not cause any dangerous states in the machine and in its surroundings.

CAUTION**Danger of personal injury and damage to property!**

Working with and on the valves without the required basic mechanical, hydraulic, and electrical knowledge may cause injuries or parts may be damaged.

- ▶ Only properly qualified and authorized users may work with and on the valves.
- ▶ ⇒ [Chap. "1.4 Selection and qualification of personnel", page 7](#)

CAUTION**Risk of damage!**

In order to prevent damage to the valves or to the machine, heed the following points:

- ▶ Values specified in the technical data must be adhered to.
- ▶ Values specified on the nameplate must be adhered to.
- ▶ ⇒ [Chap. "11 Technical Data", page 152](#)

9.1 Preparations for operation

The valves may only be operated as a component part of a higher-level overall system, for example in a machine.

⇒ [Chap. "1.3 Intended operation", page 5](#)

The following must be completed before the valve is operated:

- Qualified project planning
- Correct start-up and configuration of the valve
⇒ [Chap. "8 Start-up", page 123](#)

Preparations for valve operation

9.2 Operation of the valve

The valve is activated via signals that it receives from the machine controller.

Direct interventions by the user on the valve during normal operation are not necessary.

The device may only be operated in a safe and functional state.

At least once per shift, check valve for damage visible from the outside and defects such as leakage or damaged cables or connectors. Report changes, including to the operating behavior to the responsible department immediately.

If necessary, shut the system down immediately and secure it!

If necessary, shut the system down immediately and secure it!

Eliminate the fault immediately.

The valve has no controls, such as e.g. switches or buttons, which must be actuated.

Switching of the valve to standby or fail-safe state can also be triggered by corresponding signals at the enable input of connector X1:

- Signals between 8.5 V and 32 V based on GND at the enable input switch the valve to standby.
- Signals lower than 6.5 V at the enable input switch the valve to fail-safe state.

⇒ Chap. "3.4.3 Digital enable input", page 46

Information on maintenance:

⇒ Chap. "10.2 Maintenance", page 146

Information on correcting possible faults:

⇒ Chap. "10.3 Troubleshooting", page 147

Operation of the valve: activation via signals from the machine controller

9.3 Shutting down the valve

DANGER



Danger to life!

Hydraulic pressure and electrical supply voltage are still normally applied after the valve has been shut down. The machine is not automatically put out of operation when the valve is shut down.

Safety notes: Shutting down the valve

DANGER



Danger of poisoning and injury due to hydraulic fluid squirting out under pressure!

Contact with hydraulic fluids can damage your health (e.g. eye injuries, skin and tissue damage, poisoning in case of inhaling).

- ▶ Wear protective gloves and safety glasses.
- ▶ If hydraulic fluid gets into your eyes or on your skin, consult a doctor immediately.
- ▶ When handling hydraulic fluids, observe the safety provisions applicable to the hydraulic fluid used.

DANGER**Danger of injury due to electric voltage and unexpected movements!**

Work on machines that are not shut down presents a danger to life and limb. Work such as mounting or removal, electrical or hydraulic connection, troubleshooting or service may only be performed on machines and valves that are shut down.

- ▶ Make sure to shut the machine down and switch it off.
- ▶ Make sure that the drive motor cannot be switched on.
- ▶ For this purpose, switch off the supply voltage as well as that of connected peripherals, such as externally powered transducers or programming units.
- ▶ Make sure that all power-transmitting components and connections (electrical and hydraulic) are switched off according to the manufacturer's instructions and secured against switching on again. If possible, remove the main fuse from the machine.
- ▶ Make sure that the machine is completely depressurized.

The valve can be shut down as follows:

- Switching off of the supply voltage
- Adoption by the valve of the 'DISABLED' and 'INIT' valve states
- Signal < 6.5 V at the enable input of connector X1 (valve-dependent)

⇒ [Chap. "3.2.3 Fail-safe events", page 28](#)

If necessary, the valve must be restarted after it has been shut down or has entered the fail-safe state.

⇒ [Chap. "3.2.4 Restarting the valve", page 31](#)

Shutting down the valve

10 Service

DANGER



Danger to life!

Operating machines with damaged or defective components or with a leaking hydraulic system is dangerous and not permitted.

- ▶ Before starting up or operating the valve, check the higher-level machine including all its installed components for damage and defects.
- ▶ Pay particular attention here to higher-level and hydraulic safety devices such as, for example, EMERGENCY STOP switches and pressure-limiting valves.
- ▶ Report damage or defects to the relevant department immediately. If necessary, stop the machine immediately and secure it.
- ▶ Rectify any leaks immediately in accordance with this user manual, paying particular attention to the notes/instructions on handling in accordance with safety requirements.
- ▶ ⇒ Chap. "2.1 Handling in accordance with safety requirements", page 14
- ▶ ⇒ Chap. "10.3 Troubleshooting", page 147

Safety instructions:
Service

DANGER



Danger of explosion!

To guarantee safe operation in hazardous areas:

- ▶ The signal interfaces of the valve are implemented with explosion-proof connectors.
- ▶ For mounting and removal of the connectors as well as operation of the valve, the notes and instructions in the "Explosion-proof connectors eXLink, CEAG" operating instructions must absolutely be adhered to.
- ▶ The eXLink operating instructions from CEAG are in the Appendix to this user manual.

DANGER



Danger of poisoning and injury due to hydraulic fluid squirting out under pressure!

Contact with hydraulic fluids can damage your health (e.g. eye injuries, skin and tissue damage, poisoning in case of inhaling).

- ▶ Wear protective gloves and safety glasses.
- ▶ If hydraulic fluid gets into your eyes or on your skin, consult a doctor immediately.
- ▶ When handling hydraulic fluids, observe the safety provisions applicable to the hydraulic fluid used.

DANGER**Danger of explosion due to impermissible heating up of the valve!**

As a result of insufficient ventilation of the valve or deposits on the valve, the impermissible heating up of the valve can be such that the maximum temperatures of the certified temperature classes are exceeded.

- ▶ The valves must be checked regularly, cleaned if necessary. Deposits on the valve must be removed.
- ▶ If necessary inform the responsible person immediately and remove the valve from electrical and hydraulic operation.

DANGER**Danger of injury due to electric voltage and unexpected movements!**

Work on machines that are not shut down presents a danger to life and limb. Work such as mounting or removal, electrical or hydraulic connection, troubleshooting or service may only be performed on machines and valves that are shut down.

- ▶ Make sure to shut the machine down and switch it off.
- ▶ Make sure that the drive motor cannot be switched on.
- ▶ For this purpose, switch off the supply voltage as well as that of connected peripherals, such as externally powered transducers or programming units.
- ▶ Make sure that all power-transmitting components and connections (electrical and hydraulic) are switched off according to the manufacturer's instructions and secured against switching on again. If possible, remove the main fuse from the machine.
- ▶ Make sure that the machine is completely depressurized.

DANGER**Danger of explosion!**

To guarantee safe operation in hazardous areas:

- ▶ In its standard model with screw plug, the service connector X10 is not permitted for use in hazardous areas.
- ▶ For mounting of the screw plug of the service connector X10, it must be observed that the gasket and the threads of the screw plug as well as the threads in the electronic housing of the valve are not damaged.
- ▶ In case of damage to the screw plug of the service connector or the threads in the electronic housing, the valve must not be operated in hazardous areas.
- ▶ Tightening torque screw plug:
⇒ [Chap. "3.1.2 Representative depiction of the valve", page 18](#)

DANGER**Danger of explosion!**

The unsafe operation of the valves is dangerous.

- ▶ Only operate the valve when it is in a safe and functional state.
- ▶ At least once per shift, check valve for damage visible from the outside and defects such as leakage or damaged cables or connectors.
- ▶ The cable glands must be checked at regularly-prescribed intervals. For details, see standard EN 60079-17.
- ▶ Report changes, including to the operating behavior, damage, and defects to the responsible department immediately. If necessary, stop the machine immediately and secure it.
- ▶ ⇒ [Chap. "2.1 Handling in accordance with safety requirements", page 14](#)
- ▶ ⇒ [Chap. "10.3 Troubleshooting", page 147](#)

WARNING**Risk of injury!**

To provide protection against injuries or other damaging influences on health, suitable protective measures must be taken if necessary prior to and when carrying out any work on the valves or the machine, such as mounting or removing, electrical or hydraulic connection, troubleshooting or servicing, and when handling the valves, accessories, tools or hydraulic fluids.

- ▶ ⇒ [Chap. "2.2 Occupational safety and health", page 15](#)

WARNING**Danger of explosion!**

During shut-down, cables on the valve, cable glands, screw plugs, and connectors must not be damaged.

- ▶ The valve must not be started up with damaged cables, plug connectors, and screw plugs, and it must be sent to us or to one of our authorized service centers immediately.

CAUTION**Danger of personal and property damage due to defective accessories and defective spare parts!**

Unsuitable or defective accessories or unsuitable or defective spare parts may cause damage, malfunctions or failure of the valve or the machine.

- ▶ Use only original accessories and original spare parts.
- ▶ ⇒ [Chap. "12 Accessories, Spare Parts, and Tools", page 222](#)
- ▶ Warranty and liability claims for personal injury and damage to property are among other things excluded if they are caused by the use of unsuitable or defective accessories or unsuitable or defective spare parts.
- ▶ ⇒ [Chap. "1.8 Warranty and liability", page 11](#)

CAUTION**Risk of damage!**

The plugs, connectors, and connection cables of the valves may not be used for other purposes, such as for stepping on or as transport holders.

CAUTION**Danger of personal injury and damage to property!**

Working with and on the valves without the required basic mechanical, hydraulic, and electrical knowledge may cause injuries or parts may be damaged.

- ▶ Only properly qualified and authorized users may work with and on the valves.
- ▶ ⇒ [Chap. "1.4 Selection and qualification of personnel", page 7](#)

CAUTION**Risk of damage!**

In order to prevent damage to the valves or to the accessories:

- ▶ The plugs, connectors, and connection cables of the valves may not be used for other purposes, such as for stepping on or as transport holders.
- ▶ Due to the complexity of the internal components of the valves and of accessories, only we or our authorized service centers may make repairs and perform maintenance work other than that explained in this user manual.
- ▶ Warranty and liability claims for personal injury and damage to property are excluded among other things if they are caused by unauthorized repairs or other unauthorized interventions.
- ▶ ⇒ [Chap. "1.8 Warranty and liability", page 11](#)
- ▶ Structural changes to or opening of explosion-proof valves are not permitted since these invalidate the ex certification.

10.1 Removing of the valves

10.1.1 Tools and materials required

The following tools and materials are required for removing the valves:

- For removing and mounting the valve
Torque wrench for hexagon socket head cap screws
- Replacement for O-rings of ports to be replaced if necessary
- A shipping plate and the associated attachment elements
- For mounting the shipping plate
Wrench for hexagon socket head cap screws or regular screwdriver (only valve D671K) and if necessary wrench

**Tools and materials
required for removing**

CAUTION**Danger of personal injury and damage to property!**

Failure to heed the eXLink operating instructions from CEAG can cause bodily injuries and property damage.

- ▶ Follow the eXLink operating instructions from CEAG in the Appendix to this user manual.
- ▶ Handle all ex-protected connectors according to the notes and instructions in the eXLink operating instructions from CEAG



Structural changes to or opening of explosion-proof valves are not permitted since these invalidate the ex certification.



The installation screws and the O-rings to be replaced if necessary are not included in the scope of delivery for the valves. They are available as an accessory.

⇒ [Chap. "12 Accessories, Spare Parts, and Tools", page 222](#)

The wrench sizes of the hexagon socket cap head screws for mounting are series-specific.

Details about the screws and their tightening torque:

⇒ [Tab. 7, page 58](#)

Installation screws

The installation screws for the transport plates are type-specific. Details about attachment screws and their tightening torque:

⇒ [Chap. "12 Accessories, Spare Parts, and Tools", page 222](#)

Attachment screws

10.1.2 Removing

CAUTION

Risk of damage due to dirt and moisture!

This is the only way of adequately protecting the valves against the penetration of dirt and moisture and protecting the gaskets/seals against the effects of ozone and UV.

- ▶ The valves must not be transported or stored without their shipping plate fitted.
- ▶ The valve shipping plate may only be removed from the valve hydraulic ports directly prior to mounting and must be reinstalled directly after the valve has been removed.
- ▶ The shipping plate and the associated attachment elements (screws and nuts) must be kept for later use, e.g. during transportation.

Safety instructions: Removing of the valves

Procedure:

1. Shut down and switch off the machine and place in a de-energized and depressurized state.



For the removal of the ex-protected connectors, the notes and instructions for the eXLink operating instructions of CEAG must be heeded.

The eXLink operating instructions from CEAG are in the Appendix to this user manual.

Procedure for removing the valve

2. Disconnect the Ex-protected connectors.
3. Release the valve's installation screws.
4. Remove the valve from the mounting surface.
5. Check that O-rings in the valve ports (P, A, B, X, Y and T) are present and for elasticity, integrity and correct seating.
6. Replace hardened and damaged O-rings with new O-rings.
7. Attach the shipping plate to the valve's hydraulic ports.
The tightening torque of the attachment screws for the shipping plate is series-specific.
Guidance value: 30% of the value that is specified in table "Specification for installation screws for the valves"
⇒ [Tab. 7, page 58](#)
8. If the valve is not to be immediately reused or is to be serviced: keep valve in original packaging.
⇒ [Chap. "5 Transportation and Storage", page 52](#)
9. If necessary, seal the ports of the hydraulic system to prevent the hydraulic fluid from being contaminated.

10.2 Maintenance

Changes in temperature, effects of the hydraulic fluid, such as, for example, pressure peaks, and similar influences can, depending on the application, expose the gasket/seal materials to different levels of wear, and this in turn may cause leaks.

In order to avoid possible resulting impairments or damage, we recommend that the valve, after a period of storage or operation of more than 5 years, be inspected by us or one of our authorized service centers.



Maintenance work by the user on explosion-proof valves is not permitted. Intervention by third parties will invalidate the ex certification.



If the valve is exposed to high loads, it may be necessary to reduce the check/inspection interval to suit the application.

Embrittlement of the gasket materials

10.2.1 Checking and replacing the port O-rings

10.2.1.1 Tools and materials required

The following are required for checking and replacing the port O-rings:

- For removing and mounting the valve
Torque wrench for hexagon socket head cap screws
- Replacement for O-rings of ports to be replaced if necessary
⇒ [Chap. "12 Accessories, Spare Parts, and Tools", page 222](#)

Tools and materials required for checking and replacing the O-rings



The installation screws and the O-rings to be replaced if necessary are not included in the scope of delivery for the valves. They are available as an accessory.

⇒ [Chap. "12 Accessories, Spare Parts, and Tools", page 222](#)

The wrench sizes of the hexagon socket cap head screws for mounting are series-specific.

Details about the screws and their tightening torque:

⇒ [Tab. 7, page 58](#)

Installation screws

10.2.1.2 checking and replacing the O-rings

Procedure:

1. Remove the valve.
⇒ [Chap. "10.1 Removing of the valves", page 143](#)
2. Check that O-rings in the valve ports (P, A, B, and T, etc.) are present and for elasticity, integrity and correct seating.
3. Replace hardened and damaged O-rings with new O-rings.
4. Remount the valve.
⇒ [Chap. "6.3 Mounting the valve", page 58](#)

Procedure for checking and replacing the O-rings

10.3 Troubleshooting

The following faults may occur:

- Leak at the valve connecting surface
⇒ Chap. "10.3.1.1 Leak at the valve connecting surface", page 147
- Leak at the linear force motor screw plug
⇒ Chap. "10.3.1.2 Leak at the linear force motor screw plug", page 148
- No hydraulic response by the valve
⇒ Chap. "10.3.2 No hydraulic response by the valve", page 148
- Instability of the control loops
⇒ Chap. "10.3.3 Instability of the external control loop", page 149
⇒ Chap. "10.3.4 Instability of the internal valve control loops", page 149

Possible faults



If the fault cannot be corrected by means of the measures set out below, please contact us or one of our authorized service centers.

After correcting the fault, if necessary reinstall and restart the valve.

- ⇒ Chap. "6.3 Mounting the valve", page 58
- ⇒ Chap. "3.2.4 Restarting the valve", page 31

Restarting after correcting the fault

10.3.1 Leaks

10.3.1.1 Leak at the valve connecting surface

Measures:

- Check that O-rings in the valve ports (P, A, B, X, Y and T) are present and for elasticity, integrity and correct seating.
If necessary, install O-rings, replace or correct the seating.
- Check the valve's mounting and connecting surfaces, the valve and the hydraulic system for damage, contamination and evenness.
- Check installation screws for secure and correct seating.
Re-tighten screws if necessary with the Torque wrench for hexagon socket head cap screws.

Leak at the valve connecting surface



The wrench sizes of the hexagon socket cap head screws for mounting are series-specific.
Details about attachment screws and their tightening torque:
⇒ Tab. 7, page 58

10.3.1.2 Leak at the linear force motor screw plug

CAUTION

- ▶ In the event of a leak at the linear force motor screw plug, have the valve checked by Moog or one of its authorized service centers.

10.3.2 No hydraulic response by the valve

DANGER



Danger to life!

Touching electrically live parts can cause electric shock.

- ▶ Touching electrically live parts must therefore be avoided.

No hydraulic response by the valve

Measures:

- Check whether all the machine components, connections and ports conform to the specifications of the machine manufacturer and operator. To do so, on the valves compare the data on the nameplate with the specifications. (The details on the type plate correspond to the performance requirements ordered. They may have changed due to configuration.)
- Check whether the hydraulic installation is correct and whether all the hydraulic ports are correctly established.
- Check whether hydraulic pressure is present.
- Check whether the hydraulic supply to the pilot stage is present or correctly configured (pilot mode: external or internal).
- Check whether the supply voltage is present.
- Check whether the connectors are correctly attached and non-corroded.
- Check whether there is a command signal failure or a faulty electric cable.
- Check whether the command signal is analog or applied via the fieldbus interface (depending on the model).
- Check whether the valve is in a fault state.
If necessary, correct the fault and then cancel the fault via the fieldbus or reset the valve by switching the supply voltage off and then on again.

Typical fault causes:

- Supply voltage dips below 18 V
Electrical data: ⇒ [Chap. "11 Technical Data", page 152](#)
- Control error (for example, due to the spool sticking, which can be caused for instance by contamination)
- No command signal (e.g., due to cable break)
- Check whether the enable signal is applied. If there is no enable signal, the valve cannot be put in the 'ACTIVE' valve status.
- Check whether the configuration of the internal valve software is correct.

10.3.3 Instability of the external control loop

Measures:

- Check whether the external control loop is stable.
If necessary, reduce control loop gain.
- Check whether the internal valve control loops are stable.
⇒ [Chap. "10.3.4 Instability of the internal valve control loops", page 149](#)
- Check whether the controlled system was modified.

**Instability of the external
control loop**

10.3.4 Instability of the internal valve control loops

10.3.4.1 Flow control

Measures:

- Check whether the signal quality of the command signals is sufficient.
- Check whether the system and pilot pressures are stable.
- Check whether the quality and purity of the hydraulic fluid used conforms to the specifications of the manufacturer and the operator of the machine.
- Check whether the valve is operational.
To do so, perform a comparison of the command/actual value signals.

**Instability of the internal
valve control loops:
Flow control**

10.4 Repair

CAUTION



Danger of personal injury and damage to property!

Repaired valves or replacement valves are, like new valves, delivered with the factory settings. In the event of a repair job for defective valves, we and our authorized service centers shall not accept liability for software and data installed by the customer.

- ▶ Check the valves for correct mechanical design and correct configuration before start-up.

**Safety instructions:
Repair**

CAUTION



Danger of personal injury and damage to property!

By changing the configuration of the valves, the functionality of the valve can be changed so that it causes damage, malfunction or failure of the valve or machine.

- ▶ It is only permitted to alter the valve configuration during operation if this does not cause any dangerous states in the machine and in its surroundings.



Maintenance work by the user on explosion-proof valves is not permitted. Intervention by third parties will invalidate the ex certification.

Moog Global Support™ provides professional repair and corrective maintenance services on the highest level thanks to our experienced technicians. Our customer service and our professional expertise ensure that your systems will always remain in an optimal state. Here we offer the reliability that you can only expect from leading manufacturers with worldwide branch offices.

Moog Global Support



**MOOG Global Support
Logo**

Fig. 44: MOOG Global Support Logo

WARNING**Risk of damage!**

To guarantee safe operation in hazardous areas, the following points must be heeded:

- ▶ Maintenance work on ex-protected valves may only be performed by us or our authorized service centers.
- ▶ With the intervention of third parties, the ex certification becomes invalid.

Your advantages:

- Shorter downtimes, critical systems can be operated permanently with high performance
- Investment security thanks to reliability, adaptability, and guaranteed life span of our products
- Optimized corrective maintenance planning and system set-up
- Use of our flexible corrective maintenance program according to your service requirements

Our service offerings:

- Repair with original parts by trained technicians according to the latest Moog specifications
- Provision of original spare parts and products in order to avoid unplanned downtimes
- Flexible programs according to your needs for preventative corrective maintenance and set-up thanks to annual or multi-year contracts
- On-site service for start-up, set-up, and fault diagnosis
- Reliable service with equally good quantity worldwide

For additional information about **Moog Global Support™**, visit

<http://www.moog.com/industrial/service>



Maintenance work by the user on explosion-proof valves is not permitted. Intervention by third parties will invalidate the ex certification.



In the event of a repair job for defective valves, we and our authorized service centers reserve the right to perform a repair or, after consultation, alternatively to supply replacement valves with an identical or compatible equipment specification.

11 Technical Data

CAUTION

Risk of damage!

In order to prevent damage to the valves or to the machine, heed the following points:

- ▶ Values specified in the technical data must be adhered to.
- ▶ Values specified on the nameplate must be adhered to.
- ▶ ⇒ Chap. "11 Technical Data", page 152

CAUTION

Risk of damage!

In order to prevent damage to the valves or to the machine, heed the following points:

- ▶ Do not immerse the valves in liquids.

Description	Chapter, page
Nameplates Description of the functions of the valve, which are specified in the model number and type designation.	⇒ Chap. 11.1, page 154
Electromagnetic compatibility (EMC)	⇒ Chap. 11.2, page 163
Dimensions of the connector	⇒ Chap. 7.3, page 67
Technical data D671K – ISO 4401-05/NG10 <ul style="list-style-type: none"> - Technical data - Installation drawing/dimensions - Characteristic curves - Way functions and hydraulic symbols 	⇒ Chap. 11.3, page 164
Two-stage digital proportional valve D671K series with direct-operated pilot valve D633K	⇒ Chap. 11.3.2, page 166
Technical data D672K – ISO 4401-07/NG16 <ul style="list-style-type: none"> - Technical data - Installation drawing/dimensions - Characteristic curves - Way functions and hydraulic symbols 	⇒ Chap. 11.4, page 175
Two-stage digital proportional valve D672K series with direct-operated pilot valve D633K	⇒ Chap. 11.4.2, page 177

Technical data
D671K to D675K,
overview

Tab. 24: Overview of technical data for the series and variants (part 1 of 2)

Technical data D673K – ISO 4401-08/NG25 <ul style="list-style-type: none"> - Technical data - Installation drawing/dimensions - Characteristic curves - Way functions and hydraulic symbols 	⇒ Chap. 11.5, page 186
Two-stage digital proportional valve D673K series with direct-operated pilot valve D633K	⇒ Chap. 11.5.2 , page 188
Technical data D674K – ISO 4401-08/NG25 <ul style="list-style-type: none"> - Technical data - Installation drawing/dimensions - Characteristic curves - Way functions and hydraulic symbols 	⇒ Chap. 11.6, page 197
Two-stage digital proportional valve D674K series with direct-operated pilot valve D633K	⇒ Chap. 11.6.2 , page 199
Technical data D675K – ISO 4401-10/NG32 <ul style="list-style-type: none"> - Technical data - Installation drawing/dimensions - Characteristic curves - Way functions and hydraulic symbols 	⇒ Chap. 11.7, page 208
Two-stage digital proportional valve D675K series with direct-operated pilot valve D633K	⇒ Chap. 11.7.2 , page 210

Tab. 24: Overview of technical data for the series and variants (part 2 of 2)

11.1 Nameplates

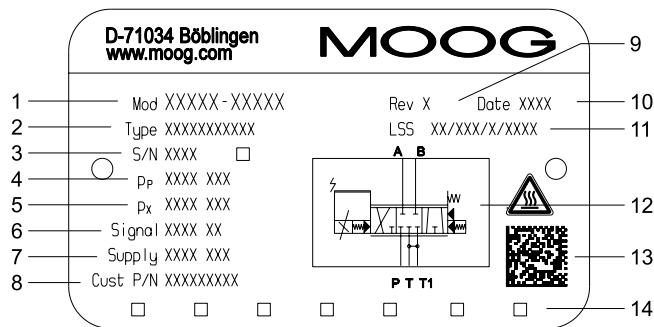

Nameplate
(example for NG10)

Item	Designation	Additional information
1	Model number	⇒ Chap. "11.1.1 Model number and type designation", page 156
2	Type designation	⇒ Chap. "1.2 Supplemental documents", page 5
3	Serial number	
4	Maximum operating pressure	Hydraulic data (series-specific) ⇒ Chap. "11 Technical Data", page 152 (table)
5	Pilot pressure	⇒ Chap. "3.3.3 Control type ports X and Y", page 37 ⇒ Chap. "3.3.1 Flow control (Q-control)", page 33
6	Signal type for analog command inputs	⇒ Chap. "3.4.1.1 Signal type identification", page 41
7	Supply voltage	see type designation: ⇒ Chap. "11.1 Nameplates", Digit 11, Supply voltage, page 161 Pin assignment of the connector X1: ⇒ Chap. "7.4.1 Pin assignment of connector X1", page 69
8	Optional customer-specific designation	
9	Optional version identification	
10	Date of manufacture in MM/YY format	
11	LSS address (decimal)	⇒ Chap. "11.1.2 LSS address", page 163
12	Hydraulic symbol	
13	Data matrix code	⇒ Chap. "11.1.3 Data matrix code", page 163
14 (only NG10)	Designation of ports	

Fig. 45: Nameplate (example)

Ex nameplate

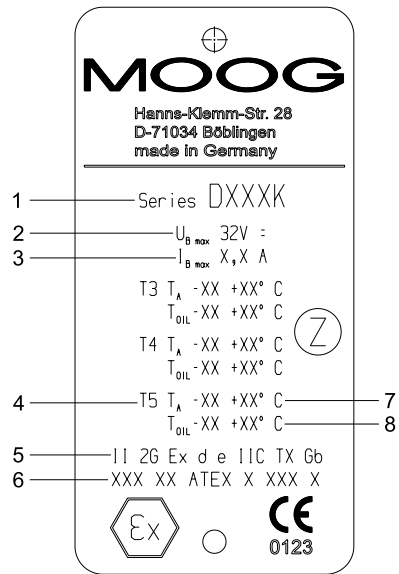

Item	Designation	Additional information
1	Series	
2	Power supply	
3	Current consumption	
4	Temperature class	T5
5	Identification	
6	Certification	
7	Ambient temperature	T_A for temperature class from item 4
8	Fluid temperature	T_{oil} for temperature class from item 4

Fig. 46: Ex nameplate (example)

The ambient and fluid temperatures may not exceed the values of the respective temperature classes.

11.1.1 Model number and type designation

When ordering the valve, its functions are specified and given in model number and the type designation.

The model number is set out as follows:

Model number

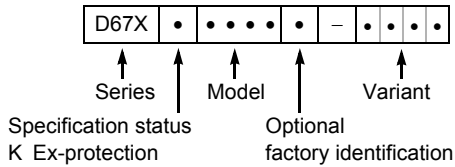

The 16-digit type designation specifies the delivery state of the valve.
By changing the valve configuration, it is possible to change the valve in such a way that it no longer conforms to this status.

Type designation

Which signal type is currently set can be ascertained for example with the Moog Valve and Pump Configuration Software.

The 2nd, 15th, and 16th digit of the type designation consist of two characters. The 15th and 16th digits are specified by the factory.

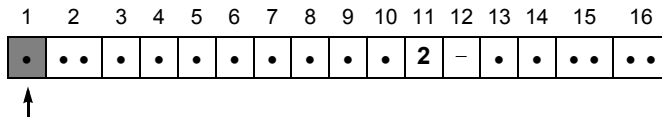

**Digit 1
spool type**

The 1st digit of the type designation of the valve provides information about the type of spool.

Variant	Spool type	Series
P	Standard spool	D671 to D675
B	Standard spool (5-way)	D671 (with P ₁ connection)

Tab. 25: Spool type in the type designation

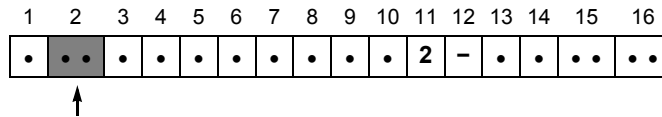

Digit 2
Rated flow Q_N

The 2nd digit of the type designation of the valve provides information about the rated flow Q_N (at $\Delta p_N = 5 \text{ bar}$ (72.5 psi) per control land: tolerance $\pm 10 \%$)

Variant	Rated flow [l/min]	Series
30	30	D671
60	60	D671
80	80	D671
01	150	D672
02	250	D672
03	350	D673
05	550	D674
10	1000	D675
15	1500	D675

Tab. 26: Rated flow variant in the type designation

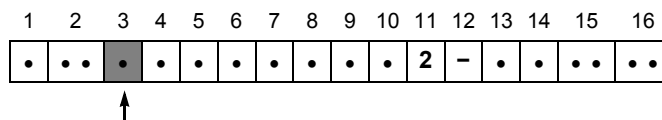

Digit 3
Maximal permissible
operating pressure

The 3rd digit of the type designation of the valve provides information about the maximum operating pressure of the pilot valve.

With internal pilot connection X, the maximum operating pressure is the maximum pilot pressure. The control parameters of the valve electronics are adapted to the control pressure.

Variant	Maximum permissible operating pressure
B	70 bar (1,015 psi)
F	210 bar (3,046 psi)
H	280 bar (4,060 psi)
K	350 bar (5,075 psi)
X	Special versions on request

Tab. 27: Maximum permissible operating pressure in the type designation

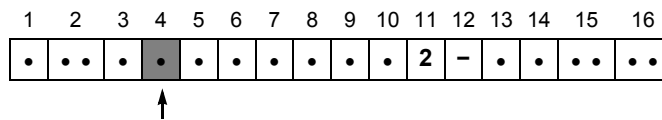

Digit 4 Spool

The 4th digit of the valve's type designation provides information about which version of the spool is integrated into the valve.

Variant	Valve configuration	Bushing-spool version
A	4-way	≈zero overlap, linear characteristic curve
D	4-way	10 % positive overlap, linear characteristic curve
R	4-way	10 % positive overlap, kinked characteristic curve
Q	5-way	Valve opening: P→A and P ₁ →B and A→T 5 % positive overlap, linear characteristic curve (only D671-B)
Y	4-way	≈ zero overlap, kinked characteristic curve
Z	2/2-way	Valve opening: A→T and B→T ₁ Valve opening: P→B and T→A only with connection X und Y external (D672 to D675)
X		Special spool on request

Tab. 28: Spool variant in the type designation

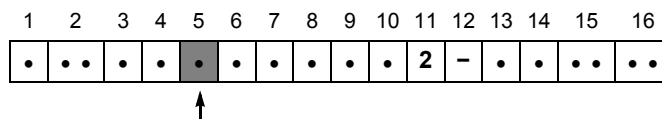

Digit 5 Pilot valve

The 5th digit of the valve's type designation provides information about which version of the pilot valve is integrated into the valve.

Variant	Pilot valve	Series
S	Single-stage drive pilot valve D633K	D671K to D675K

Tab. 29: Pilot valve variant in the type designation

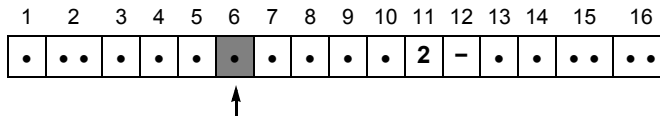

Digit 6
Fail-safe variant

The 6th digit of the valve's type designation provides information about which mechanical fail-safe function is integrated into the valve.

The following table describes the spool positions of the main stage in case of failure of the valve electronics, the control pressure or the control pressure of the optional 4/2-way valve of the D67XK valve with the D633K pilot valve.

Fail-safe state in case of failure, tables

Fail-safe Function	Spool position of the Main stage	Pilot pressure ¹	Supply voltage	
			Valve Electronics	4/2-way seat valve
F	End position: P→B and A→T	ON:	off	-
	undefined	off	ON:	-
	End position: P→B and A→T	off	off	-
D	End position: P→A and B→T (D671: approx. 20 % P→A and B→T)	ON:	off	-
	undefined	off	ON:	-
	End position: P⇒A and B→T (D671: approx. 20 % P→A and B→T)	off	off	-
K	undefined	ON:	off	ON:
		off	ON:	ON:
		off	off	ON:
	Defined middle position	ON:	off	off
		off	ON:	off
H	End position: P→B and A→T	ON:	off	ON:
	undefined	off	ON:	ON:
	Defined middle position and defined P→B and A→T	off	off	ON:
		ON:	off	off
		off	ON:	off
off	off	off		

Position of the spool of the main stage in case of failure, D67XK valve with direct-operated pilot valve D633K

Tab. 30: Spool position in case of failure, D67X with pilot valve D633K



All other combinations of pressure and supply voltage give rise to an undefined main stage spool position.

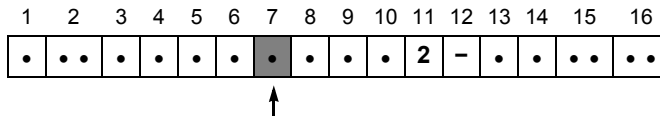

Digit 7
Hydraulic control type,
 Pilot pressure port X
 and leakage port Y

The 7th digit in the valve type designation provides information about whether pilot pressure port X and leakage port Y are internally or externally connected in the valve.

Variant	Intake X	Drain Y
4	internally connected	internally connected
5	externally connected	internally connected
6	externally connected	externally connected
7	internally connected	externally connected

Tab. 31: Variant of pilot pressure and leakage port in the type designation



For selection limitations, see the hydraulic symbols.
 "Valve configurations and hydraulic symbols" (series-specific)
 ⇒ [Chap. "11 Technical Data", page 152 \(table\)](#)

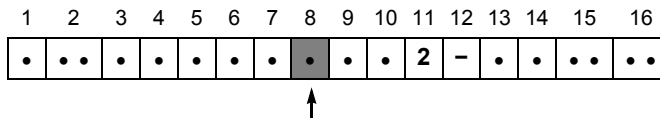

Digit 8
Seal material

The 8th digit in the type designation of the valve designates the sealing material used.

H	HNBR	D671K to D674K
V	FKM	D671K to D675K
S	Edge seal HNBR	D675K
X		Special versions on request

Tab. 32: Seal material variant in the type designation

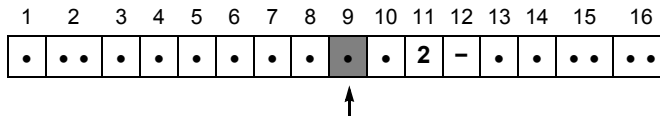

Digit 9
Valve connector X1

The 9th digit of the valve's type designation specifies the version of the valve connector X1.

J	7-pole	
---	--------	--

Tab. 33: Variant of the valve connector X1 in the type designation

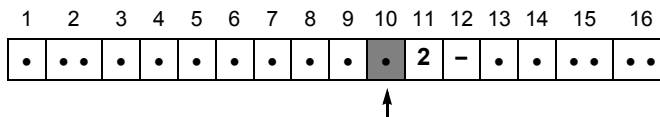

Digit 10
Command signal for 100 % spool stroke

The 10th digit of the valve's type designation provides information about which signal type is set in the valve on delivery.

The signal type of the command signal input applies in combination with the signal type of the spool position signal (actual value output).

Variant	Command signals for 100 % spool stroke	
	Command signal (I_{in} and U_{in}) (X1, input contacts 1 and 2)	Stroke position signal (I_{out} and U_{out}) (X1, output contact 4)
D	± 10 V	2–10 V
E	4–20 mA	4–20 mA
M	± 10 V	4–20 mA
X	± 10 mA	4–20 mA
9	Fieldbus	Fieldbus
Y	Others on request.	

Tab. 34: Signal types command value and spool position signal in the type designation

The analog command signal I_{in} or U_{in} is the flow command value input. The stroke position signal (actual output value) I_{out} or U_{out} is proportional to the mechanical position of the spool.

⇒ Chap. "7 Electrical connection", page 61

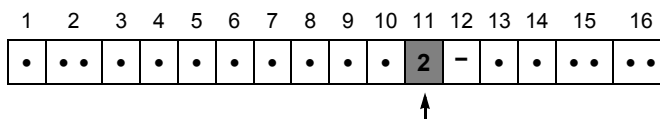

Digit 11
Supply voltage

The 11th digit of the type designation specifies the supply voltage:

2	nominal 24 V DC
---	-----------------

⇒ Chap. "7 Electrical connection", page 61

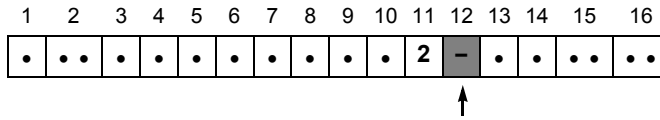

Digit 12

The 12th digit of the type designation is specified by the factory.

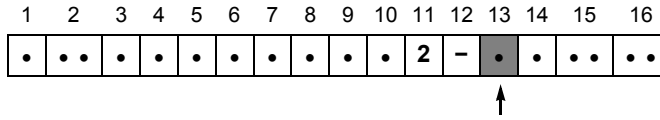

Digit 13

The 13th digit of the type designation of the valve provides information about the position of the spool with switched-off enable signal (X1)..

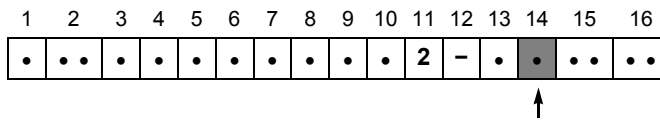

Digit 14
Fieldbus connectors X3 and X4

The 14th digit of the type designation specifies whether the valve has a fieldbus interface and which is the one in question.

Variant	Fieldbus connector
G	CAN
H	Profibus DP
J	EtherCAT
O	without fieldbus interface

Tab. 35: Variant of the fieldbus connector X3 and X4 in the type designation

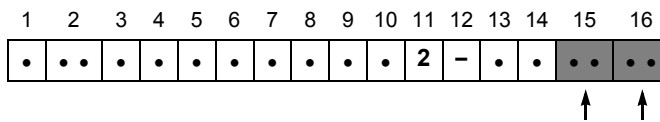

Digits 15 and 16

The 15th and 16th digits of the type designation are specified by the factory.

11.1.2 LSS address

The decimal LSS address is set out in accordance with [CiA DSP 305](#) as follows and serves to provide the CAN bus node with an internationally unique identification:

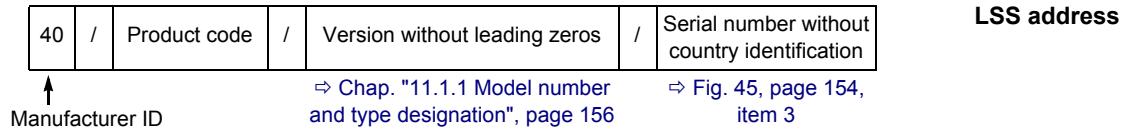

Example:

40/43/1/4321



Even valves without CAN bus interfaces are assigned a decimal LSS address during manufacturing.

11.1.3 Data matrix code

The data matrix code is a two-dimensional code. The code on the nameplate contains a character string that is set out as follows:

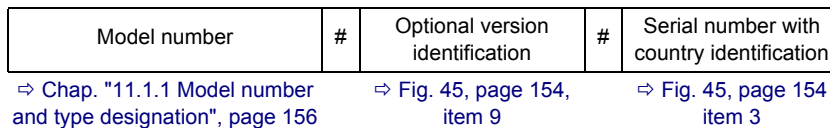

If there is no optional version identification, a blank space appears here.

Example:

D671-K215A-0001#C#D4321

11.2 Electromagnetic compatibility (EMC)

The valves in the D671 to D675 series fulfill the EMC protection requirements for immunity to interference as per [EN 61000-6-2:2005](#) (evaluation criterion A) and for emitted interference as per [EN 61000-6-4:2005](#) (CAN bus and Profibus DP) or as per [EN 61000-6-3:2005](#) (EtherCAT).

The following technical requirements must be in place so that the EMC protection requirements can be fulfilled:

- Use of the mating connectors recommended for the valves
⇒ Chap. "12 Accessories, Spare Parts, and Tools", page 222
- Adequate shielding
- Version of equipotential bonding system, protective grounding, and electrical shielding.
⇒ Chap. "7.12.2 Equipotential bonding and protective grounding", page 91

Electromagnetic compatibility (EMC)

11.3 Technical data D671K – ISO 4401-05/NG10

The technical data apply for the two-stage proportional valves in the D671K series

- with direct-operated pilot valve D633K
 - ⇒ Chap. "Mounting surface", page 165
 - ⇒ Chap. "11.3.2 Data D671K with direct-operated pilot valve D633K", page 166
 - ⇒ Chap. "Dimensions (installation drawing), with fail-safe F and D", page 168
 - ⇒ Chap. "Valve configurations and hydraulic symbols", page 169/page 169
 - ⇒ Chap. "Characteristic curves D671K valves with direct-operated pilot valve D633K", page 172

11.3.1 Mounting surface



If the valve is mounted on the mounting surface, it projects lengthwise (x-axis) over the mounting surface.

Valve dimensions:

⇒ Chap. " Dimensions (installation drawing), with fail-safe F and D", page 168

Technical data for the mounting surface

11.3.1.1 Mounting pattern of mounting surface

The holes in the mounting surface must correspond to ISO 4401-05-05-0-05.



Mounting length at least 100 mm.



- For the 5-way version type B80..., T₁ becomes P₁ (see holes Fig. 47)
- For valves in the 4-way version and with Q_N > 60 l/min and in 2/2-way version, the second tank connection T₁ is required.

The holes (Fig. 47) apply for the two-stage digital proportional valve in the D671K series with direct-operated pilot valve D633K.

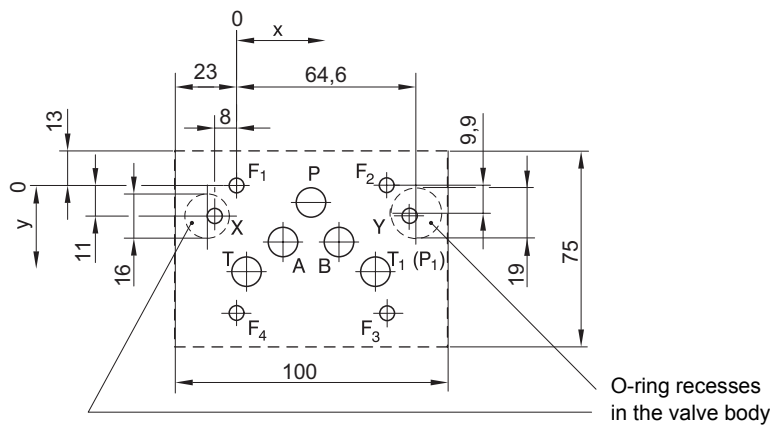

Mounting pattern of mounting surface according to ISO 4401-05-05-0-05 for D671K with direct-operated pilot valve D633K

T₁ optional

	P	A	B	T	T ₁	X	Y	F ₁	F ₂	F ₃	F ₄
	Ø 11.5 (0.45)	Ø 11.5 (0.45)	Ø 11.5 (0.45)	Ø 11.5 (0.45)	Ø 11.5 (0.45)	Ø 6.3 (0.25)	Ø 6.3 (0.25)	M6	M6	M6	M6
X	27 (1.06)	16.7 (0.66)	37.3 (1.47)	3.2 (0.13)	50.8 (2.00)	-8 (-0.31)	62 (2.44)	0	54 (2.13)	54 (2.13)	0
Y	6.3 (0.25)	21.4 (0.84)	21.4 (0.84)	32.5 (1.28)	32.5 (1.28)	11 (0.43)	11 (0.43)	0	0	46 (1.81)	46 (1.81)

Fig. 47: Holes in the mounting surface for D671K series (dimensions in mm and (in))



- For maximum flow, the ports for P, T, A, and B must contrary to the standard be designed with a diameter of 11.5 mm (0.45 in).
- F₁...F₄ are threaded holes for attachment screws in the holes of the mounting surface of the valve.

11.3.2 Data D671K with direct-operated pilot valve D633K

Valve design	Proportional valve, two-stage, with standard spools			General technical data
Pilot valve	D633K			
Nominal size and holes	NG10, mounting pattern according to ISO 4401-05-05-0-05, with T ₁ ⇒ Fig. 47, page 165			
Mounting position	In any position, fixed or movable			
Diameter of the connection holes and threads of the fastening holes	P, A, B, T, and T1		11.5 mm	Permissible ambient conditions
	X and Y		6.3 mm	
	F ₁ to F ₄		M6	
	⇒ Fig. 47, page 165			
Mass	approx. 13.3 kg (29.3 lb) Valves with fail-safe functions H and K approx. 14.5 kg (32 lb)			
Dimensions	⇒ "Dimensions (installation drawing), with fail-safe F and D", page 168			
Ambient temperature ¹⁾	for transport/storage ²⁾	recommended	15 °C to 25 °C	
		permissible	–40 °C to 80 °C	
	for operation	(–40 on request)	–20 °C to 60 °C	
	Depending on the certified temperature classes			
Rel. humidity for storage	< 65 % not condensing			
Vibration resistance ³⁾	10 g, 3 axes, Frequency: 10 to 2,000 Hz (according to EN 60068-2-6)			
Shock resistance ³⁾	50 g, 6 directions, half-sine 3 ms (as per EN 60068-2-27)			
Valve configurations	5-way, 4-way, 3-way, 2/2-way and 2-way operation ⇒ Chap. "3.3.2 Valve configurations and hydraulic symbols", page 34			Hydraulic data
Operating pressure ⁴⁾ of the pilot valve	via T or Y	p _T or p _y +10 bar		
	Operating pressure range X port	10 to 350 bar		
	max. pressure Y port ⁵⁾	70 bar		
Maximum operating pressure range of main stage	Ports P, A, and B	350 bar		
	Port T for Y internal ⁵⁾	70 bar		
	Port T for Y external	250 bar		
Maximum flow Q_{max}	180 l/min (48 gpm) ⇒ Chap. "4.1 Flow diagram (4-way operation)", page 49			
Rated flow Q_N for Δp _N = 5 bar per control land	30 / 60 / 80 / 2 x 80 l/min (8 / 16 / 21 / 2 x 21 gpm) (depending on the series variant ⇒ Chap. "Type designation", "Digit 2, rated flow Q _N ", page 157)			
Leakage flow Main stage Q_L	1.8 l/min (0.3/0.5 gpm) (≈ zero overlap)			
Pilot flow static	Pilot valve	standard	0.4 l/min (0.1 gpm)	
		trimmed	0.4 l/min (0.1 gpm)	
Pilot flow at 100 % jump	Pilot valve	standard	6.0 l/min (1.6 gpm)	
		trimmed	6.5 l/min (1.7 gpm)	
Hydraulic fluid				
Permissible fluids	Mineral-oil-based hydraulic oil as per DIN 51524-1 1 to 3 and ISO11158 Other fluids on request			
Permissible temperature	(–40 ° on request) –20 ° to 80 ° depending on the certified temperature classes			
Viscosity ν	recommended		15 to 45 mm ² /s	
	permissible		5 to 400 mm ² /s	
Purity class ⁶⁾ , recommended (ISO 4406)	for functional safety <18/15/12 for life cycle (wear) <17/14/11			

Tab. 36: Technical data D671K with direct-operated pilot valve D633K (part 1 of 2)

Step response time for 0 to 100 % spool stroke	Pilot valve 11 ms Step response and frequency response ⇒ page 173	Static and dynamic data
Threshold	< 0.05 %	
Hysteresis	< 0.2 %	
Zero shift at $\Delta T = 55 \text{ K}$	< 1.5 %	
Manufacturing tolerance	$\pm 10 \%$	
Relative duty cycle	100 %	Electrical data
Protection type	IP66 with mounted mating connectors (according to EN 60529)	
Supply voltage	Nominal 24 V (18 to 32 V) DC based on GND, Only use SELV-/PELV power supply according to EN 60204-1 At supply voltages less than 18 V, the valve is rendered in the fail-safe state. ⇒ Chap. "3.2.3 Fail-safe events", page 28	
Max. current consumption static	0.3 A	
Max. current consumption dynamic	1.2 A	
External fuse protection for each valve	1.6 A slow-blowing fuse	
EMC protection requirements	Immunity to interference as per EN 61000-6-2:2005 (evaluation criterion A) Emitted interference as per EN 61000-6-4:2005 (CAN bus and Profibus DP) or as per EN 61000-6-3:2005 (EtherCAT) ⇒ Chap. "11.2 Electromagnetic compatibility (EMC)", page 163	
Connectors	⇒ Chap. "7 Electrical connection", page 61 ⇒ Chap. "7.4.1 Pin assignment of connector X1", page 69	
Triggering electronics	Digital control electronics integrated into the valve	

Tab. 36: Technical data D671K with direct-operated pilot valve D633K (part 2 of 2)

- 1) The ambient temperature and the temperature of the hydraulic fluid influence the temperature of the valve electronics. In order to ensure that the electronic components integrated in the valve last as long as possible, we recommend that the hydraulic fluid be kept at as low a temperature as possible at as low an ambient temperature as possible. A reference temperature is measured in the valve electronics. Fault-free operation is guaranteed up to a reference temperature of 85 °C (185 °F). At reference temperatures over 85 °C (185 °F) a warning is output via the field bus on valves with field bus interfaces. At reference temperatures over 105 °C (221 °F) the valve electronics are deactivated; the valve adopts the 'DISABLED' valve status and thus the mechanical fail-safe state.
⇒ [Chap. "3.2 Safety function/fail-safe", page 25](#)
- 2) **Temperature fluctuations** >10 °C must be avoided during storage.
- 3) Transportation and storage should be as **vibration- and shock-free** as possible.
- 4) **Hydraulic data** was measured at operating pressure $p_P = 210 \text{ bar}$ (3,046 psi), viscosity of hydraulic fluid $\nu = 32 \text{ mm}^2/\text{s}$ and temperature of hydraulic fluid $T = 40 \text{ °C}$ (104 °F)
⇒ [Chap. "6 Mounting and Connection to the Hydraulic System", page 56](#)
- 5) Pressure peaks up to 210 bar permissible
- 6) The **cleanliness of the hydraulic fluid** has a great effect on functional safety (reliable spool positioning, high resolution) and wear of the spool lands (pressure gain, leakage losses).

Two-stage digital proportional valve D671K series with direct-operated pilot valve D633K

Dimensions (installation drawing), with fail-safe F and D

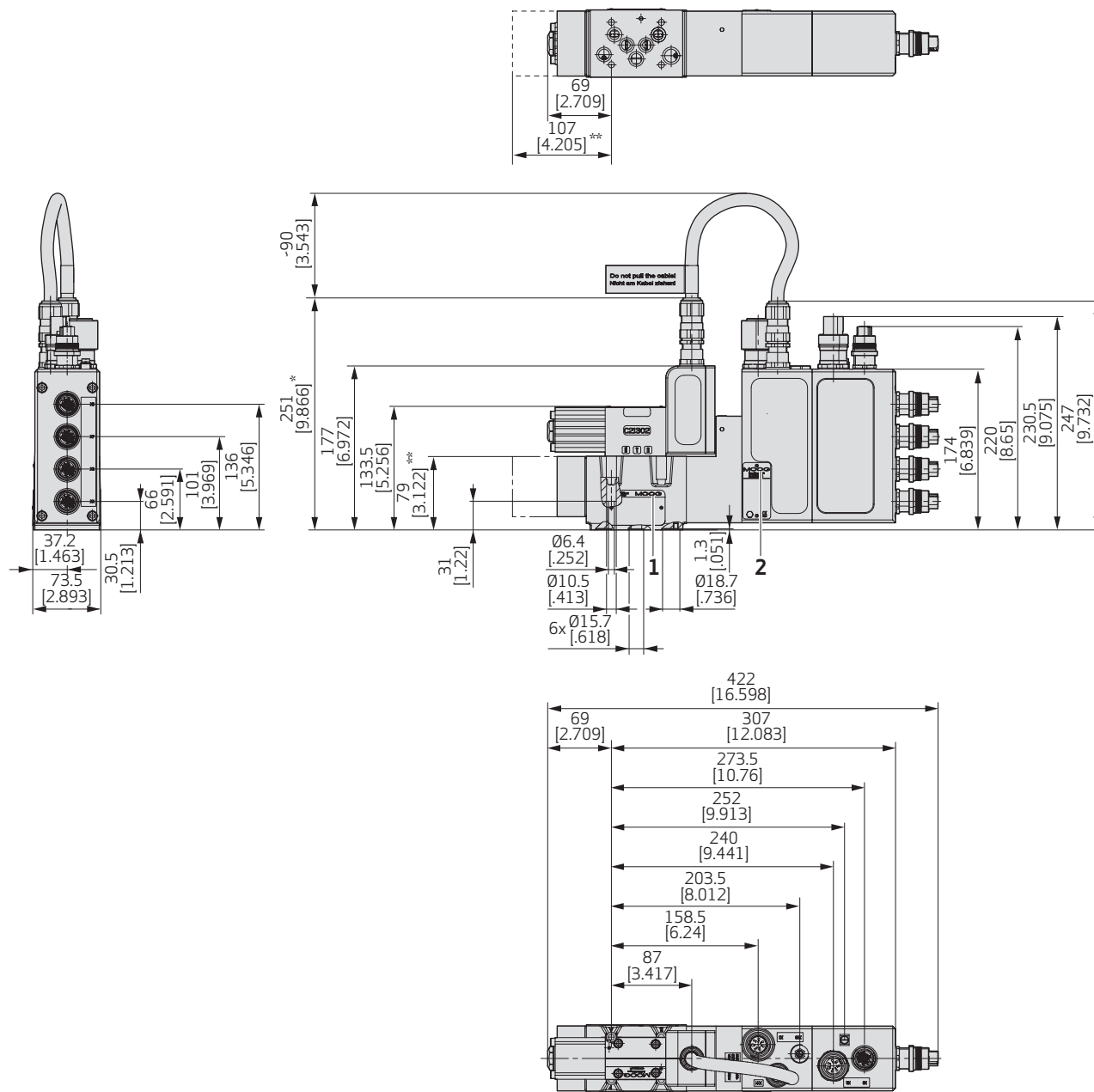

Fig. 48: Installation drawing for D671K (dimensions in mm and (in))

Pos.	Designation	Additional information
1	Type plate	⇒ Fig. 45, page 154
2	Ex type plate	⇒ Fig. 46, page 155

Installation space of the plug connector when mounted: ⇒ Fig. 14, page 67

*) Dimension with fixed cabling of the pilot valve with explosion-proof wiring. If the cabling of the pilot valve makes use of explosion-proof plug connectors, the installation space of the valve increases by 50 mm

Valve configurations and hydraulic symbols

Fail-safe function F
5-way version

X and Y optionally external or internal

Port P₁ required
P₁ does not correspond to ISO 4401

Port P₁ is equivalent to port T₁

Fail-safe function F
4-way version

X and Y optionally external or internal

Tank port T₁ at Q_N > 60 l/min required

Fail-safe function M
2/2-way version

only X and Y external

Tank port T₁ required

Execute flow direction according to symbols.

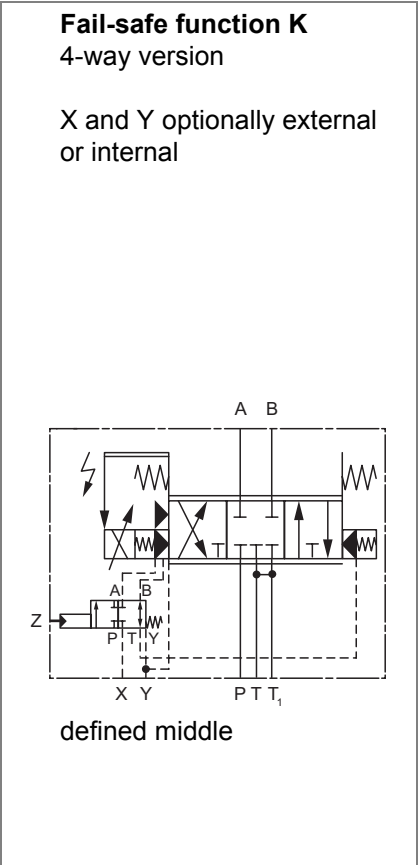
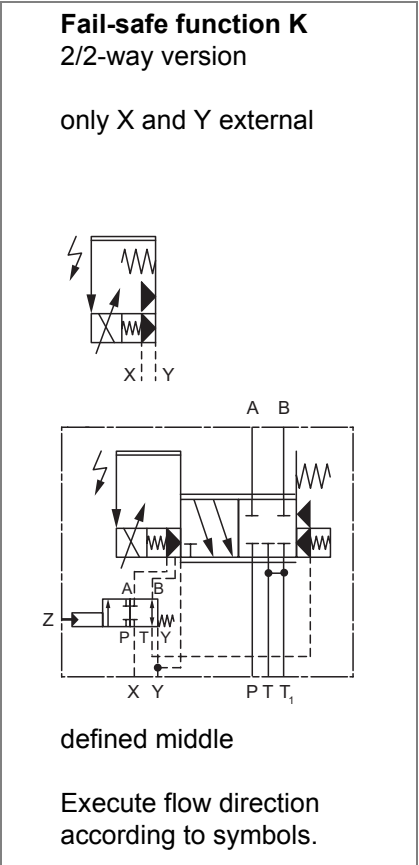
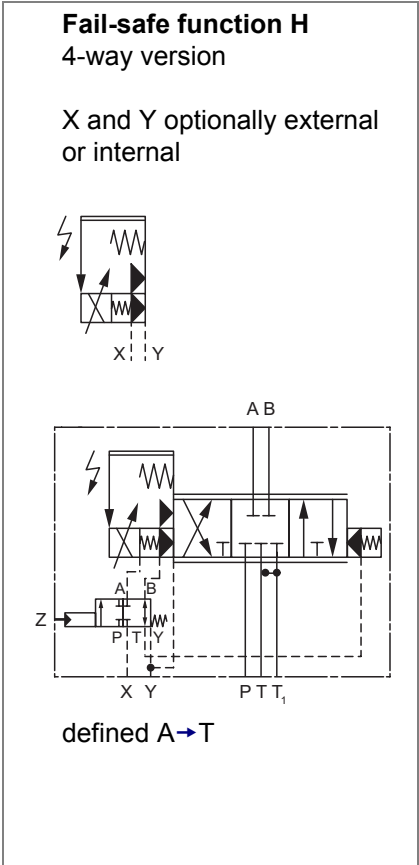

Characteristic curves D671K valves with direct-operated pilot valve D633K



- All characteristic curves in the section "Characteristic curves D671K valves with pilot valve D633K" are typical characteristic curves for the D671K valve with pilot valve D633K measured at operating pressure $p_P = 210 \text{ bar}$ (3,046 psi), viscosity of hydraulic fluid $\nu = 32 \text{ mm}^2/\text{s}$ and temperature of hydraulic fluid $T = 40 \text{ }^\circ\text{C}$ (104 $^\circ\text{F}$)
- For $Q_N > 60 \text{ l/min}$, a second tank port T_1 is required.

Flow diagram (4-way operation)

⇒ Chap. "4.1 Flow diagram (4-way operation)", page 49

Flow diagram

Flow signal characteristic curve at rated pressure drop $\Delta p_N = 10 \text{ bar}$, that is, $\Delta p_N = 5 \text{ bar}$ per control land:

Flow signal characteristic curve

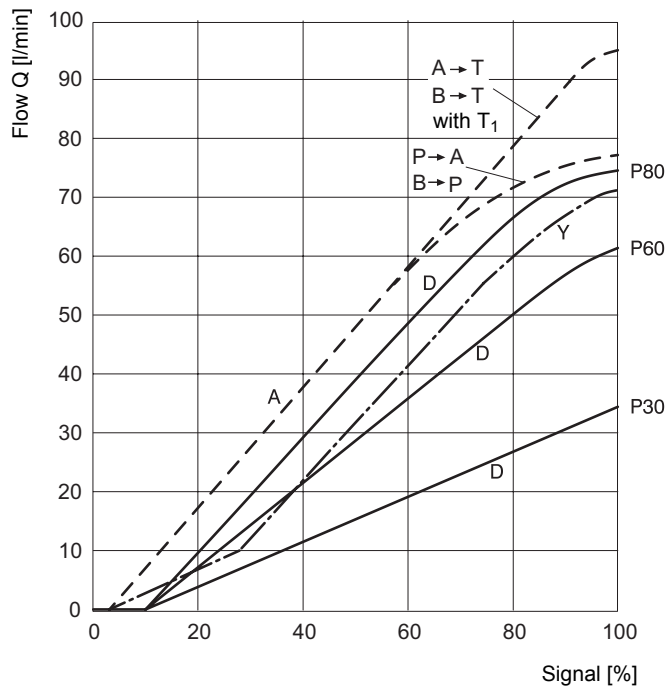

Spool A	≈ zero overlap, linear characteristic curve
Spool D	10 % positive overlap, linear characteristic curve
Spool Y	≈ zero overlap, kinked characteristic curve
P30	type: standard spool rated flow 30 l/min
P60	type: standard spool rated flow 60 l/min
P80	type: standard spool rated flow 80 l/min

Fig. 50: Valve D671K, flow-signal characteristic curve

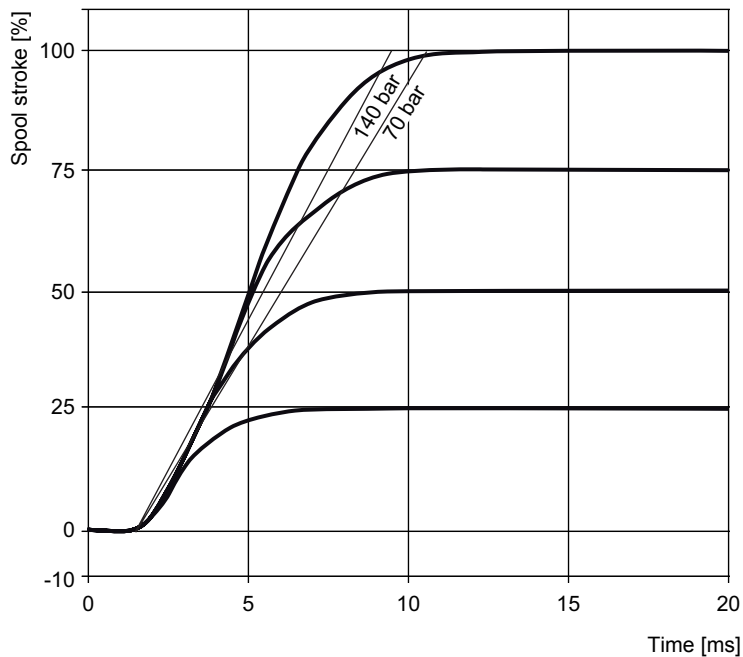

Step response for D671K valves with direct-operated pilot valve D633K, standard

Fig. 51: Step response for D671K valves, standard

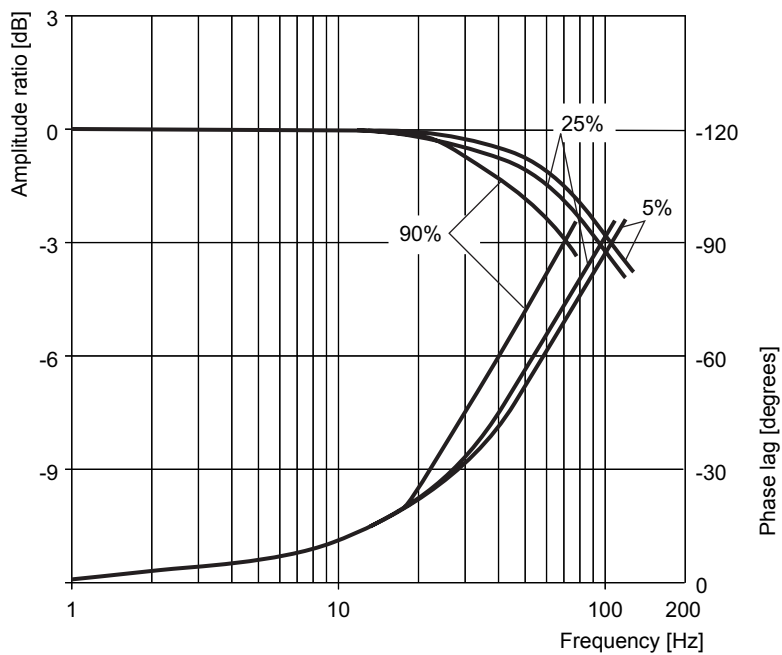

Frequency response for D671K valves with direct-operated pilot valve D633K, standard

Fig. 52: Frequency response for D671K valves, standard

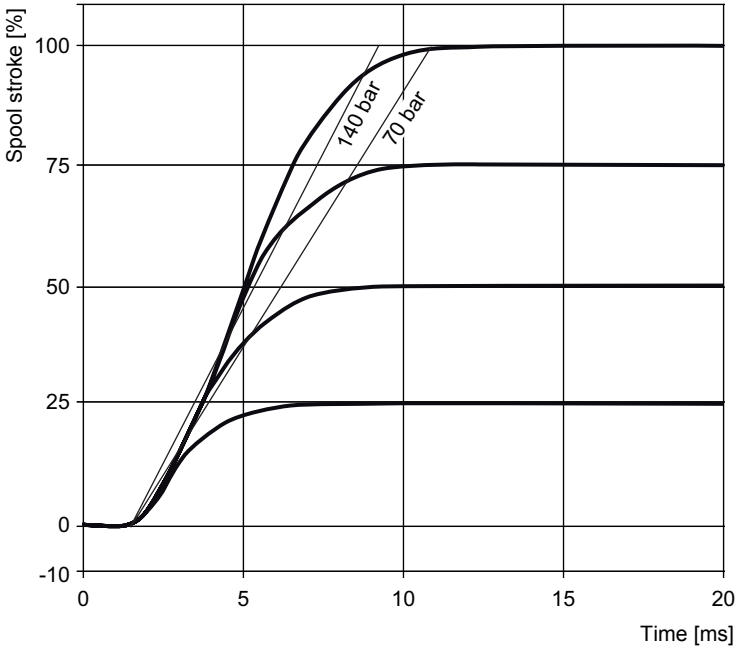

Step response for D671K valves with direct-operated pilot valve D633K, trimmed

Fig. 53: Step response for D671K valves, trimmed

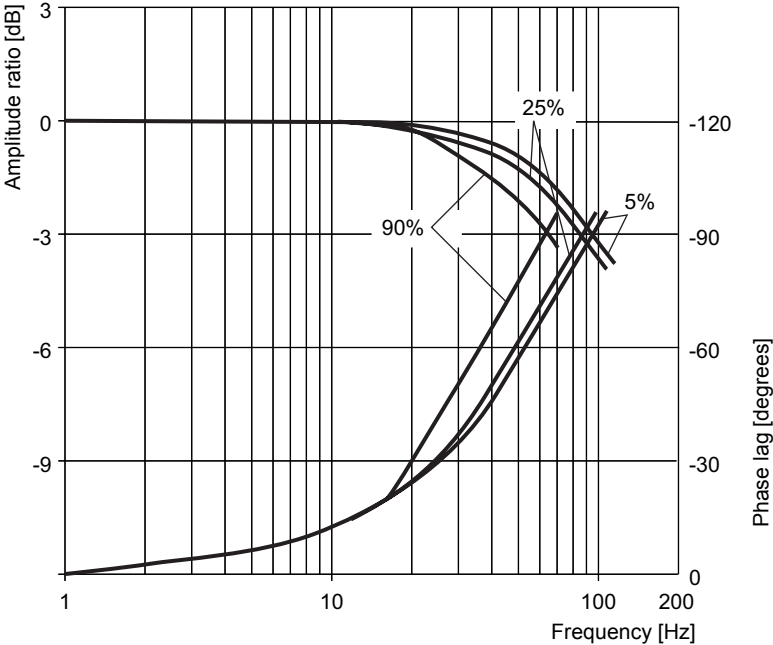

Frequency response for D671K valves with direct-operated pilot valve D633K, trimmed

Fig. 54: Frequency response for D671K valves, trimmed

11.4 Technical data D672K – ISO 4401-07/NG16

The technical data apply for proportional valves in the D672K series

- two-stage, with direct-operated pilot valve D633K
 - ⇒ Chap. "Mounting surface", page 176
 - ⇒ Chap. "11.4.2 Data D672K with direct-operated pilot valve D633K", page 177
 - ⇒ Chap. " Dimensions (installation drawing), with fail-safe F and D", page 179
 - ⇒ Chap. " Valve configurations and hydraulic symbols", page 180/page 180
 - ⇒ Chap. "Characteristic curves D672K valves with direct-operated pilot valve D633K", page 183

11.4.1 Mounting surface



If the valve is mounted on the mounting surface, it projects lengthwise (x-axis) over the mounting surface.

Valve dimensions:

⇒ Chap. "Dimensions (installation drawing), with fail-safe F and D", page 179

Technical data for the mounting surface

11.4.1.1 Mounting pattern of mounting surface

The holes in the mounting surface must correspond to ISO 4401-07-07-0-05.

The holes (Fig. 55) apply for the digital proportional valve in the D672K series

- two-stage, with direct-operated pilot valve D633K

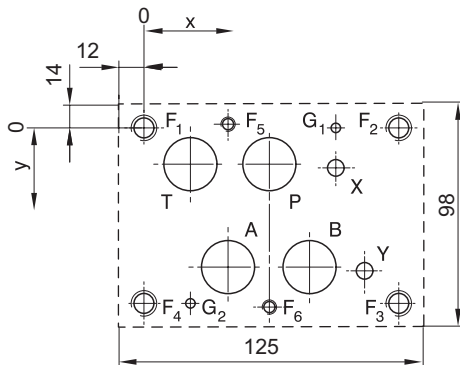

Mounting pattern of mounting surface according to ISO 4401-07-07-0-05 D672K

	P	A	T	B	X	Y	G ₂	G ₂	F ₁	F ₂	F ₃	F ₄	F ₂	F ₂
	dia. 20 (0.79)	dia. 20 (0.79)	dia. 20 (0.79)	dia. 20 (0.79)	dia. 6.3 (0.25)	dia. 6.3 (0.25)	dia. 4	dia. 4	M10	M10	M10	M10	M6	M6
X	50	34.1	18.3	65.9	76.6	88.1	76.6	18.3	0	101.6	101.6	0	34.1	50
Y	14.3	55.6	14.3	55.6	15.9	57.2	0	69.9	0	0	69.9	69.9	-1.6	71.5

Fig. 55: Holes in the mounting surface for the D672K series (dimensions in mm and (in))



- For maximum flow, the ports for P, T, A, and B must contrary to the standard be designed with a diameter of 20 mm (0.79 in).
- F₁...F₄ are threaded holes for attachment screws in the mounting surface of the valve.
- G₁ and G₂ are holes for accommodating the transposition-proof pins of the valve.

11.4.2 Data D672K with direct-operated pilot valve D633K

Valve design	Proportional valve, two-stage, with standard spool			General Technical data
Pilot valve	D633K standard or trimmed			
Nominal size and holes	NG16, mounting pattern according to ISO 4401-07-07-0-05 ⇒ Fig. 55, page 176			
Mounting position	In any position, fixed or movable			
Diameter of the connection holes and threads of the fastening holes	P, A, T, and B		20 mm	Permissible ambient conditions
	X and Y		6.3 mm	
	F ₁ to F ₄		M10	
	F ₁ to F ₄		M10	
	G ₁ and G ₂		4 mm	
	⇒ Fig. 55, page 176			
Mass	approx. 18.5 kg (40.8 lb) Valves with fail-safe functions H and K approx. 20 kg (44 lb)			
Dimensions	⇒ "Dimensions (installation drawing), with fail-safe F and D", page 179			
Ambient temperature ¹⁾	for transport/storage ²⁾	recommended	15 °C to 25 °C	
		permissible	–40 °C to 80 °C	
	for operation	(–40 °C on request)	–20 °C to 60 °C	
	depending on the certified temperature classes			
Rel. humidity for storage	< 65 % not condensing			
Vibration resistance ³⁾	10 g, 3 axes, Frequency: 10 to 2,000 Hz (according to EN 60068-2-6)			
Shock resistance ³	50 g, 6 directions, half-sine 3 ms (as per EN 60068-2-27)			
Valve configurations	4-way, 3-way, 2/2-way and 2-way operation ⇒ Chap. "3.3.2 Valve configurations and hydraulic symbols", page 34			Hydraulic data
Operating pressure ⁴⁾ of the pilot valve	via T or Y	p _T or p _y	+10 bar	
	Operating pressure range X port		10 to 350 bar	
	max. pressure Y port ⁵⁾		70 bar	
Maximum operating pressure range of main stage	Ports P, A, and B		350 bar	
	Port T for Y internal ⁵⁾		70 bar	
	Port T for Y external		350 bar	
Maximum flow Q_{max}	600 l/min (158.5 gpm) ⇒ Chap. "4.1 Flow diagram (4-way operation)", page 49			
Rated flow Q_N for Δp _N = 5 bar per control land	150 / 250 l/min (40 / 66 gpm) (depending on the series variant ⇒ Chap. "Type designation", "Digit 2, rated flow Q _N ", page 157)			
leakage flow Main stage Q_L	2.5 l/min (0.7 gpm) (≈ zero overlap)			
Pilot flow static	Pilot valve	standard	0.5 l/min (0.1 gpm)	
		trimmed	0.5 l/min (0.1 gpm)	
Pilot flow at 100 % jump	Pilot valve	standard	35 l/min (9.3 gpm)	
		trimmed	26 l/min (6.9 gpm)	
Hydraulic fluid				
Permissible fluids	Mineral-oil-based hydraulic oil as per DIN 51524-1 1 to 3 and ISO11158 Other fluids on request			
Permissible temperature	(–40 ° on request) –20 ° to 80 ° depending on the certified temperature classes			
Viscosity ν	recommended		15 to 45 mm ² /s	
	permissible		5 to 400 mm ² /s	
Purity class ⁶⁾ , recommended (ISO 4406)	for functional safety <18/15/12 for life cycle (wear) <17/14/11			

Tab. 37: Technical data D672K with direct-operated pilot valve D633K (part 1 of 2)

Step response time for 0 to 100 % spool stroke	Pilot valve	standard	11 ms	Static and dynamic data
		trimmed	13 ms	
	Step response and frequency response ⇒ page 184			
Threshold	< 0.1 %			
Hysteresis	< 0.2 %			
Zero shift at $\Delta T = 55 \text{ K}$	< 1 %			
Manufacturing tolerance	$\pm 10 \%$			
Relative duty cycle	100 %			Electrical data
Protection type	IP66 with mounted mating connectors (according to EN 60529)			
Supply voltage	Nominal 24 V (18 to 32 V) DC based on GND. Only use SELV-/PELV power supply according to EN 60204-1 At supply voltages less than 18 V, the valve is rendered in the fail-safe state. ⇒ Chap. "3.2.3 Fail-safe events", page 28			
Max. current consumption static	0.3 A			
Max. current consumption dynamic	1.2 A			
External fuse protection for each valve	1.6 A slow-blowing fuse			
EMC protection requirements	Immunity to interference as per EN 61000-6-2:2005 (evaluation criterion A) Emitted interference as per EN 61000-6-4:2005 (CAN bus and Profibus DP) or as per EN 61000-6-3:2005 (EtherCAT) ⇒ Chap. "11.2 Electromagnetic compatibility (EMC)", page 163			
Connectors	⇒ Chap. "7 Electrical connection", page 61 ⇒ Chap. "7.4.1 Pin assignment of connector X1", page 69			
Triggering electronics	Digital control electronics integrated into the valve			

Tab. 37: Technical data D672K with direct-operated pilot valve D633K (part 2 of 2)

- 1) The ambient temperature and the temperature of the hydraulic fluid influence the temperature of the valve electronics. In order to ensure that the electronic components integrated in the valve last as long as possible, we recommend that the hydraulic fluid be kept at as low a temperature as possible at as low an ambient temperature as possible. A reference temperature is measured in the valve electronics. Fault-free operation is guaranteed up to a reference temperature of 85 °C (185 °F). At reference temperatures over 85 °C (185 °F) a warning is output via the field bus on valves with field bus interfaces. At reference temperatures over 105 °C (221 °F) the valve electronics are deactivated; the valve adopts the 'DISABLED' valve status and thus the mechanical fail-safe state.
⇒ [Chap. "3.2 Safety function/fail-safe", page 25](#)
- 2) **Temperature fluctuations** >10 °C must be avoided during storage.
- 3) Transportation and storage should be as **vibration- and shock-free** as possible.
- 4) **Hydraulic data** was measured at operating pressure $p_P = 210 \text{ bar}$ (3,046 psi), viscosity of hydraulic fluid $\nu = 32 \text{ mm}^2/\text{s}$ and temperature of hydraulic fluid $T = 40 \text{ °C}$ (104 °F)
⇒ [Chap. "6 Mounting and Connection to the Hydraulic System", page 56](#)
- 5) **Pressure peaks** up to 210 bar permissible
- 6) The **cleanliness of the hydraulic fluid** has a great effect on functional safety (reliable spool positioning, high resolution) and wear of the spool lands (pressure gain, leakage losses).

Two-stage digital proportional valve D672K series with direct-operated pilot valve D633K

Dimensions (installation drawing), with fail-safe F and D

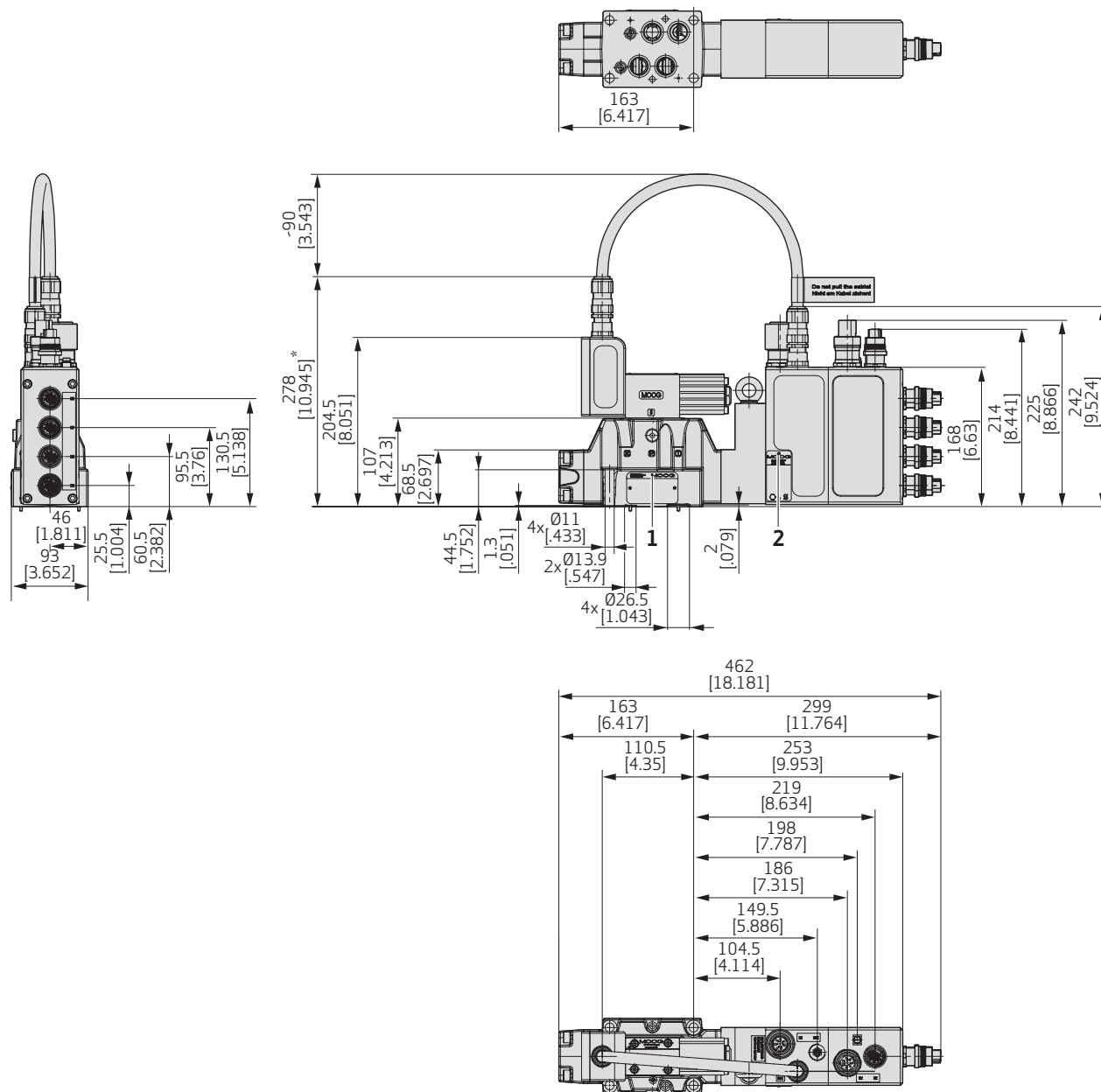

Fig. 56: Installation drawing for D672K (dimensions in mm and (in))

Pos.	Designation	Additional information
1	Type plate	⇒ Fig. 45, page 154
2	Ex type plate	⇒ Fig. 46, page 155

Installation space of the plug connector when mounted: ⇒ Fig. 14, page 67

*) Dimension with fixed cabling of the pilot valve with explosion-proof wiring. If the cabling of the pilot valve makes use of explosion-proof plug connectors, the installation space of the valve increases by 50 mm.

Valve configurations and hydraulic symbols

Fail-safe function F
4-way version

X and Y optionally external
or internal

A B
P T

Fail-safe function M
2/2-way version

only X and Y external

A B
X Y P T

Execute flow direction
according to symbols.

Two-stage digital proportional valve D672K series with direct-operated pilot valve D633K with fail-safe function H and K for applications with safety requirements

Dimensions (installation drawing), mechan./hydr. fail-safe H and K

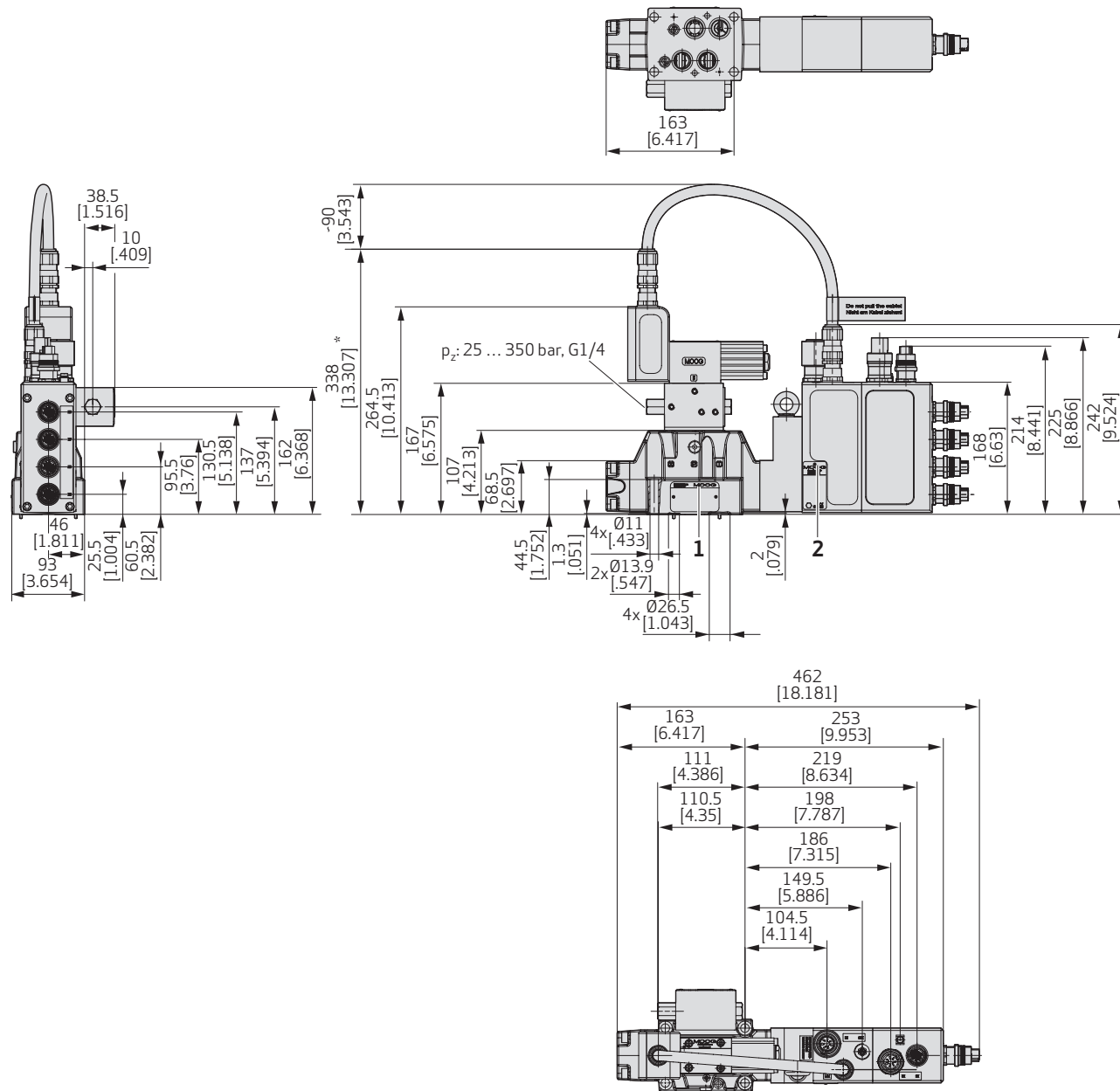
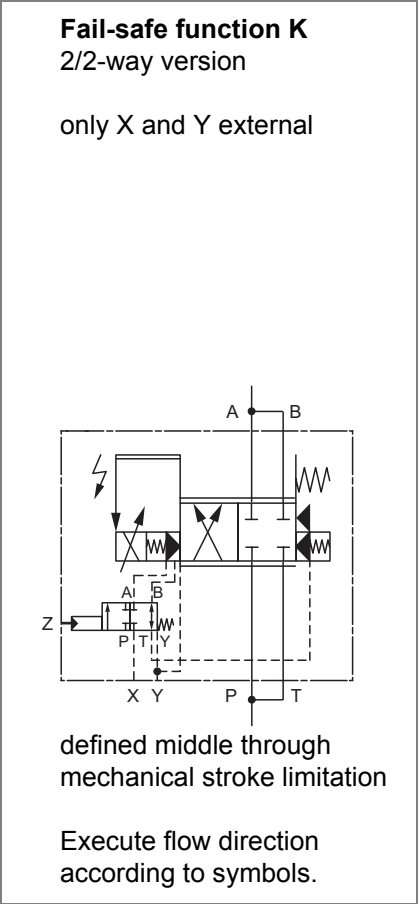
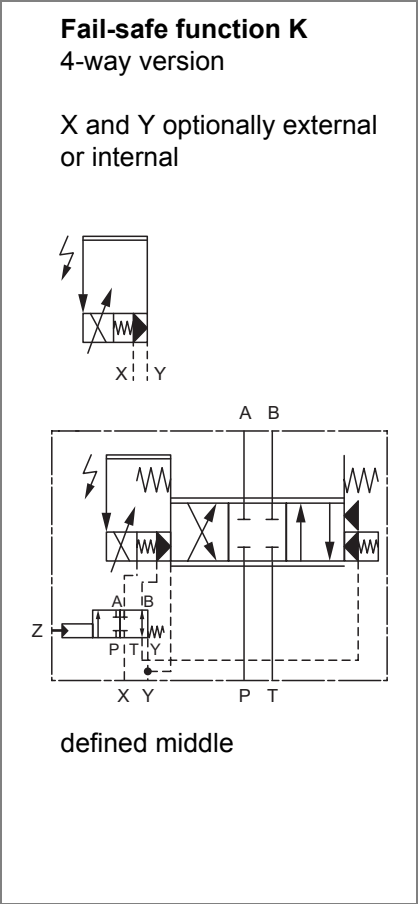
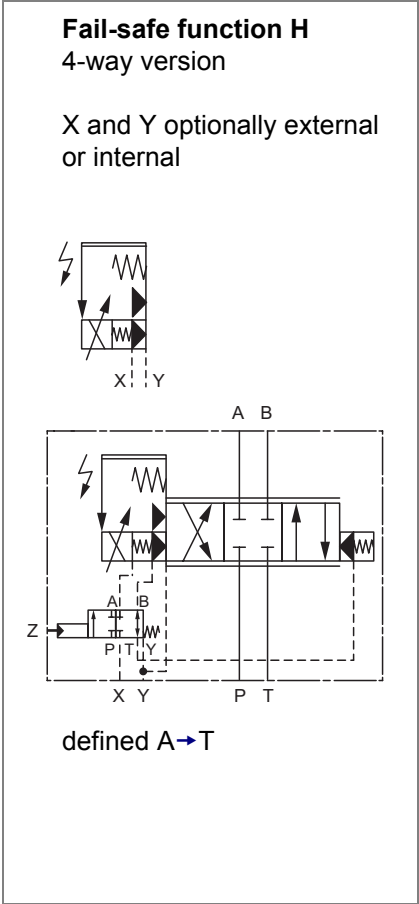

Fig. 57: Installation drawing for D672K (dimensions in mm and (in))

Pos.	Designation	Additional information
1	Type plate	⇒ Fig. 45, page 154
2	Ex type plate	⇒ Fig. 46, page 155

Installation space of the plug connector when mounted: ⇒ Fig. 14, page 67

*) Dimension with fixed cabling of the pilot valve with explosion-proof wiring. If the cabling of the pilot valve makes use of explosion-proof plug connectors, the installation space of the valve increases by 50 mm.



Characteristic curves D672K valves with direct-operated pilot valve D633K



All characteristic curves in the section "Characteristic curves D672K valves with pilot valve D633K" are typical characteristic curves for the D672K valve with pilot valve D633K measured at operating pressure $p_P = 210$ bar (3,046 psi), viscosity of hydraulic fluid $\nu = 32$ mm²/s and temperature of hydraulic fluid $T = 40$ °C (104 °F)

Flow diagram (4-way operation)

⇒ Chap. "4.1 Flow diagram (4-way operation)", page 49

Flow diagram

Flow signal characteristic curve at rated pressure drop $\Delta p_N = 10$ bar, that is, $\Delta p_N = 5$ bar per control land:

Flow signal characteristic curve

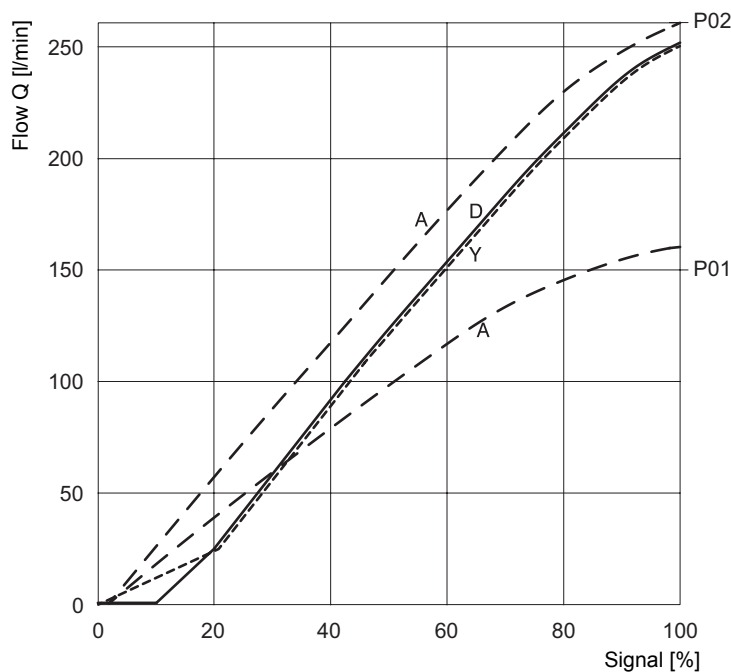

- Spool A ≈ zero overlap, linear characteristic curve
- Spool D 10 % positive overlap, linear characteristic curve
- Spool Y ≈ zero overlap, kinked characteristic curve
- P01 type: standard spool rated flow 150 l/min
- P02 type: standard spool rated flow 250 l/min

Fig. 58: Valve D672K, flow-signal characteristic curve

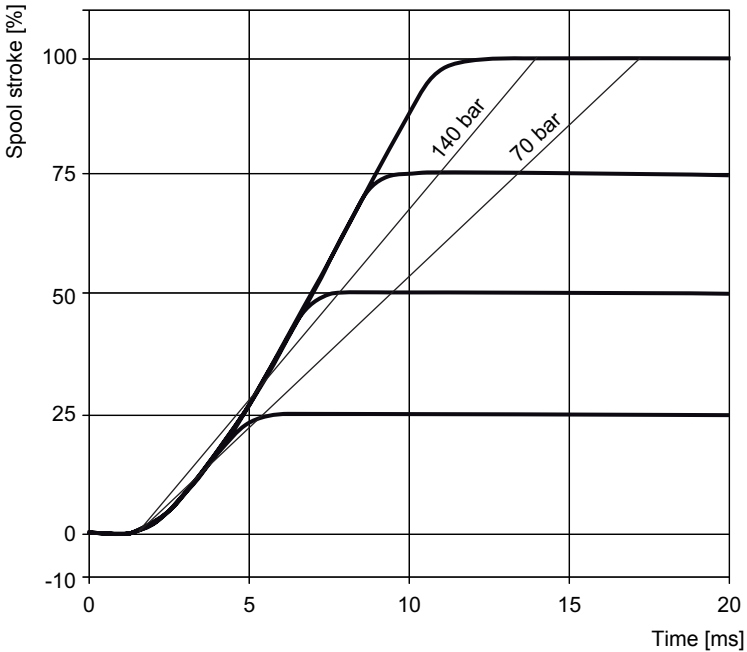

Step response for D672K valves with direct-operated pilot valve D633K, standard

Fig. 59: Step response for D672K valves, standard

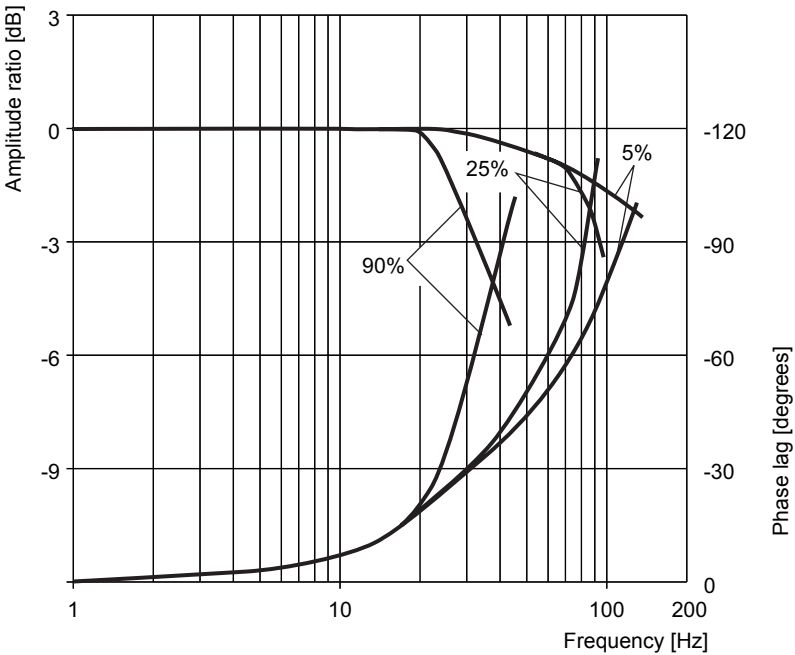

Frequency response for D672K valves with direct-operated pilot valve D633K, standard

Fig. 60: Frequency response for D672K valves, standard

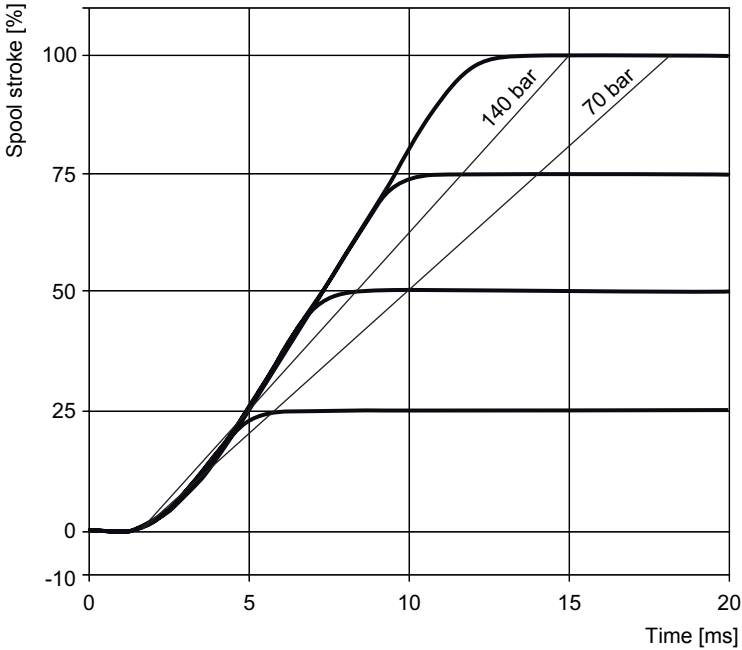

Step response for D672K valves with direct-operated pilot valve D633K, trimmed

Fig. 61: Step response for D672K valves, trimmed

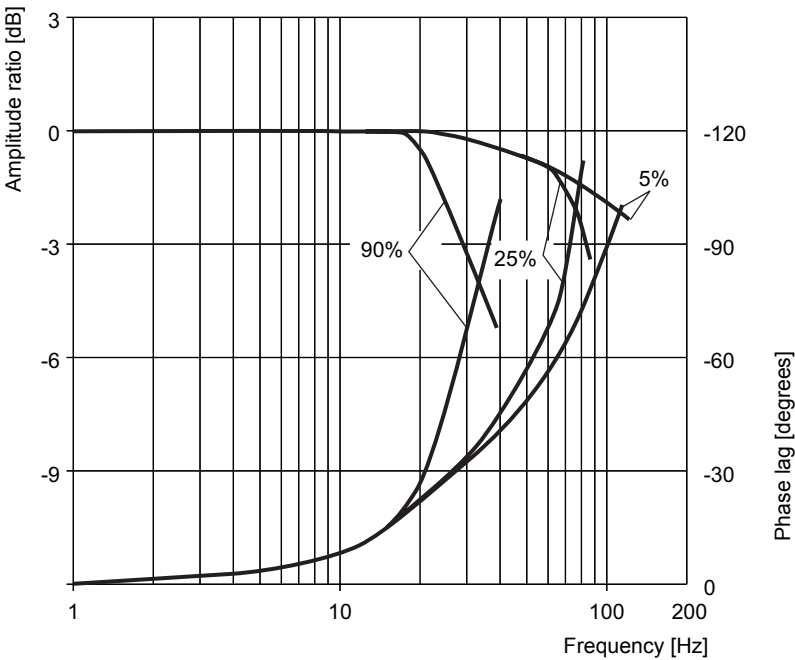

Frequency response for D672K valves with direct-operated pilot valve D633K, trimmed

Fig. 62: Frequency response for D672K valves, trimmed

11.5 Technical data D673K – ISO 4401-08/NG25

The technical data apply for proportional valves in the D673K series

- two-stage, with direct-operated pilot valve D633K
 - ⇒ Chap. "11.5.2 Data D673K with direct-operated pilot valve D633K", page 188
 - ⇒ Chap. "Technical data for the mounting surface", page 187
 - ⇒ Chap. "Dimensions (installation drawing), with fail-safe F and D", page 190
 - ⇒ Chap. "Valve configurations and hydraulic symbols", page 191/page 191
 - ⇒ Chap. "Characteristic curves D673K valves with direct-operated pilot valve D633K", page 194

11.5.1 Mounting surface



If the valve is mounted on the mounting surface, it projects lengthwise (x-axis) over the mounting surface.

Valve dimensions:

⇒ Chap. "Dimensions (installation drawing), with fail-safe F and D", page 190

Technical data for the mounting surface

11.5.1.1 Mounting pattern of mounting surface

The holes in the mounting surface must correspond to ISO 4401-08-08-0-05.

The holes (Fig. 63) apply for the digital proportional valve in the D673K series

- two-stage, with direct-operated pilot valve D633K

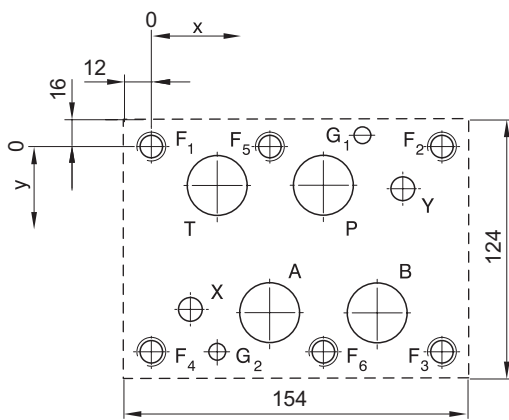

Mounting pattern of mounting surface according to ISO 4401-08-08-0-05 D673K

	P	A	T	B	X	Y	G ₂	G ₂	F ₁	F ₂	F ₃	F ₄	F ₂	F ₂
	dia. 28 (1.1)	dia. 28 (1.1)	dia. 28 (1.1)	dia. 28 (1.1)	dia. 11.2 (0.44)	dia. 11.2 (0.44)	dia. 7.5 (0.30)	dia. 7.5 (0.30)	M12	M12	M12	M12	M12	M12
X	77	53.2	29.4	100.8	17.5	112.7	94.5	29.4	0	130.2	130.2	0	53.2	77
Y	17.5	74.6	17.5	74.6	73	19	-4.8	92.1	0	0	92.1	92.1	0	92.1

Fig. 63: Holes in the mounting surface for the D673K series (dimensions in mm and (in))



- For maximum flow, the ports for P, T, A, and B must contrary to the standard be designed with a diameter of 28 mm (1.1 in).
- F₁...F₄ are threaded holes for attachment screws in the mounting surface of the valve.
- G₁ and G₂ are holes for accommodating the transposition-proof pins of the valve.

11.5.2 Data D673K with direct-operated pilot valve D633K

Valve design	Proportional valve, two-stage, with standard spools			General Technical data
Pilot valve	D633K standard or trimmed			
Nominal size and holes	NG25, mounting pattern according to ISO 4401-08-08-0-05 ⇒ Fig. 63, page 187			
Mounting position	In any position, fixed or movable			
Diameter of the connection holes and threads of the fastening holes	P, A, T, B, and X		28 mm	Permissible ambient conditions
	X and Y		11.2 mm	
	F ₁ to F ₆		M12	
	G ₁ and G ₂		7.5 mm	
	⇒ Fig. 63, page 187			
Mass	approx. 26.5 kg (58.4 lb) Valves with fail-safe functions H and K approx. 28 kg (61.7 lb)			
Dimensions	⇒ "Dimensions (installation drawing), with fail-safe F and D", page 190/page 190			
Ambient temperature ¹⁾	for transport/storage ²⁾	recommended	15 °C to 25 °C	
		permissible	–40 °C to 80 °C	
	for operation	(–40 °C on request)	–20 °C to 60 °C	
	depending on the certified temperature classes			
Rel. humidity for storage	< 65 % not condensing			
Vibration resistance ³⁾	10 g, 3 axes, Frequency: 10 to 2,000 Hz (according to EN 60068-2-6)			
Shock protection ³⁾	50 g, 6 directions, half-sine 3 ms (as per EN 60068-2-27)			
Valve configurations	4-way, 3-way, 2/2-way and 2-way operation ⇒ Chap. "3.3.2 Valve configurations and hydraulic symbols", page 34			Hydraulic data
Operating pressure ⁴⁾ of the pilot valve	via T or Y	p _T or p _y	+10 bar	
	Operating pressure range X port		10 to 350 bar	
	max. pressure Y port ⁵⁾		70 bar	
Maximum operating pressure range of main stage	Ports P, A, and B		350 bar	
	Port T for Y internal ⁵⁾		70 bar	
	Port T for Y external		350 bar	
Maximum flow Q_{max}	1500 l/min (396 gpm) ⇒ Chap. "4.1 Flow diagram (4-way operation)", page 49			
Rated flow Q_N for Δp _N = 5 bar per control land	350 l/min (92.5 gpm)			
Leakage flow Main stage Q_L	3.0 l/min (0.8 gpm) (≈ zero overlap)			
Pilot flow static	Pilot valve	standard	0.5 l/min (0.1 gpm)	
		trimmed	0.5 l/min (0.1 gpm)	
Pilot flow at 100 % jump	Pilot valve	standard	35 l/min (9.2 gpm)	
		trimmed	26 l/min (6.9 gpm)	
Hydraulic fluid				
Permissible fluids	Mineral-oil-based hydraulic oil as per DIN 51524-1 1 to 3 and ISO11158 Other fluids on request			
Permissible temperature	(–40 ° on request) –20 ° to 80 ° depending on the certified temperature classes			
Viscosity ν	recommended		15 to 45 mm ² /s	
	permissible		5 to 400 mm ² /s	
Purity class ⁶⁾ , recommended (ISO 4406)	for functional safety < 18/15/12 for life cycle (wear) < 17/14/11			

Tab. 38: Technical data D673K with direct-operated pilot valve (part 1 of 2)

Step response time for 0 to 100 % spool stroke	Pilot valve	standard	15 ms	Static and dynamic data
		trimmed	18 ms	
Step response and frequency response ⇒ page 195				
Threshold	< 0.1 %			
Hysteresis	< 0.2 %			
Zero shift at $\Delta T = 55 \text{ K}$	< 1 %			
Manufacturing tolerance	$\pm 10 \%$			
Relative duty cycle	100 %			
protection type	IP66 with mounted mating connectors (according to EN 60529)			
Supply voltage	Nominal 24 V (18 to 32 V) DC based on GND. Only use SELV-/PELV power supply according to EN 60204-1			
	At supply voltages less than 18 V, the valve is rendered in the fail-safe state. ⇒ Chap. "3.2.3 Fail-safe events", page 28			
Max. current consumption static	0.3 A			Electrical data
Max. current consumption dynamic	1.2 A			
External fuse protection for each valve	1.6 A slow-blowing fuse			
EMC protection requirements	Immunity to interference as per EN 61000-6-2:2005 (evaluation criterion A)			
	Emitted interference as per EN 61000-6-4:2005 (CAN bus and Profibus DP) or as per EN 61000-6-3:2005 (EtherCAT) ⇒ Chap. "11.2 Electromagnetic compatibility (EMC)", page 163			
Connectors	⇒ Chap. "7 Electrical connection", page 61 ⇒ Chap. "7.4.1 Pin assignment of connector X1", page 69			
Triggering electronics	Digital control electronics integrated into the valve			

Tab. 38: Technical data D673K with direct-operated pilot valve (part 2 of 2)

- 1) The ambient temperature and the temperature of the hydraulic fluid influence the temperature of the valve electronics. In order to ensure that the electronic components integrated in the valve last as long as possible, we recommend that the hydraulic fluid be kept at as low a temperature as possible at as low an ambient temperature as possible. A reference temperature is measured in the valve electronics. Fault-free operation is guaranteed up to a reference temperature of 85 °C (185 °F). At reference temperatures over 85 °C (185 °F) a warning is output via the field bus on valves with field bus interfaces. At reference temperatures over 105 °C (221 °F) the valve electronics are deactivated; the valve adopts the 'DISABLED' valve status and thus the mechanical fail-safe state.
⇒ [Chap. "3.2 Safety function/fail-safe", page 25](#)
- 2) **Temperature fluctuations** > 10 °C must be avoided during storage.
- 3) Transportation and storage should be as **vibration- and shock-free** as possible.
- 4) **Hydraulic data** was measured at operating pressure $p_p = 210 \text{ bar}$ (3,046 psi), viscosity of hydraulic fluid $\nu = 32 \text{ mm}^2/\text{s}$ and temperature of hydraulic fluid $T = 40 \text{ °C}$ (104 °F)
⇒ [Chap. "6 Mounting and Connection to the Hydraulic System", page 56](#)
- 5) Pressure peaks up to 210 bar permissible
- 6) The **cleanliness of the hydraulic fluid** has a great effect on functional safety (reliable spool positioning, high resolution) and wear of the spool lands (pressure gain, leakage losses).

Two-stage digital proportional valve D673K series with direct-operated pilot valve D633K

Dimensions (installation drawing), with fail-safe F and D

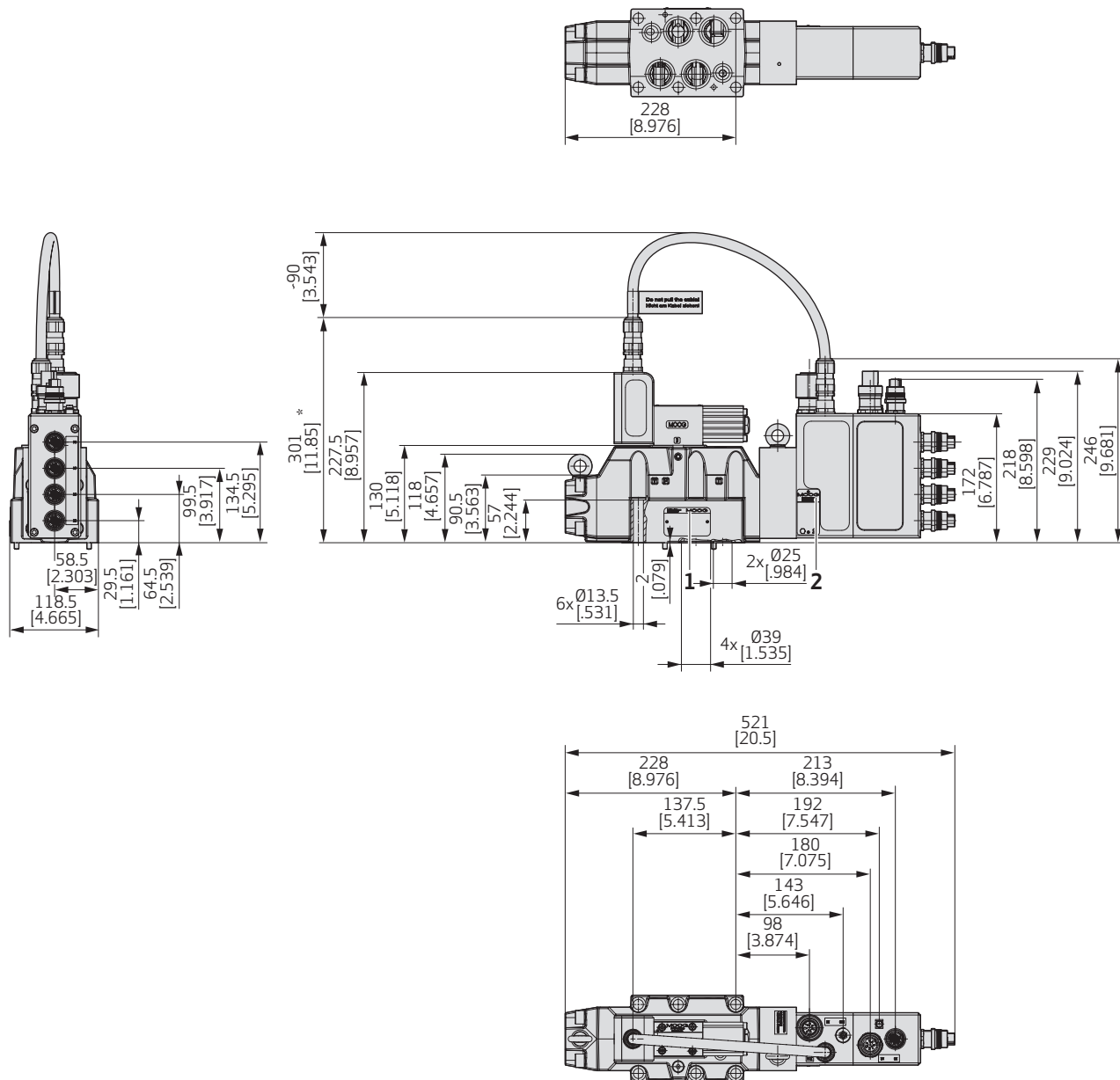

Fig. 64: Installation drawing for D673K (dimensions in mm and (in))

Pos.	Designation	Additional information
1	Type plate	⇒ Fig. 45, page 154
2	Ex type plate	⇒ Fig. 46, page 155

Installation space of the plug connector when mounted: ⇒ Fig. 14, page 67

*) Dimension with fixed cabling of the pilot valve with explosion-proof wiring. If the cabling of the pilot valve makes use of explosion-proof plug connectors, the installation space of the valve increases by 50 mm.

Valve configurations and hydraulic symbols

Fail-safe function F
4-way version

X and Y optionally external
or internal

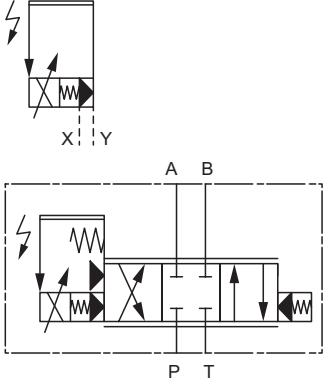

A B
P T

Fail-safe function M
2/2-way version

only X and Y external

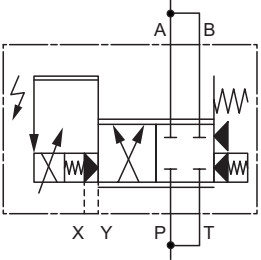

A B
X Y P T

Execute flow direction
according to symbols.

Two-stage digital proportional valve D673K series with direct-operated pilot valve D633K with fail-safe function H and K for applications with safety requirements

Dimensions (installation drawing), mechan./hydr. fail-safe H and K

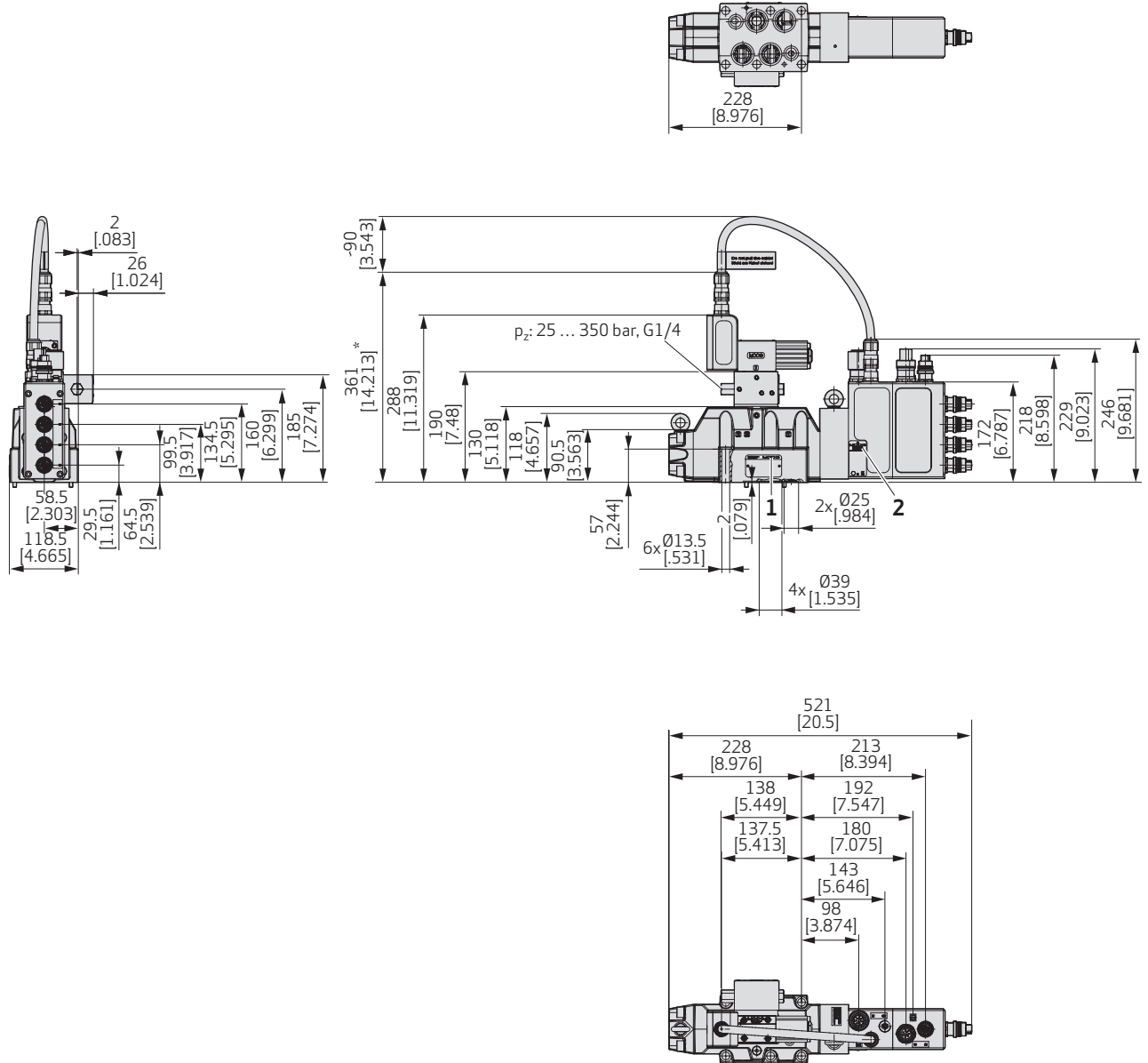
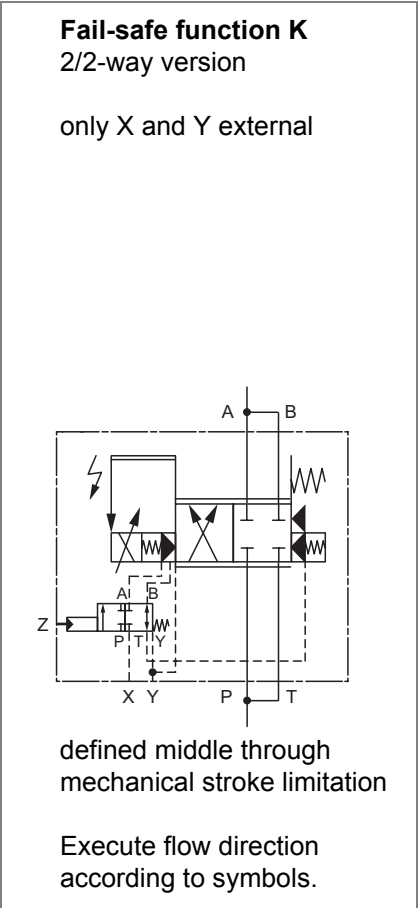
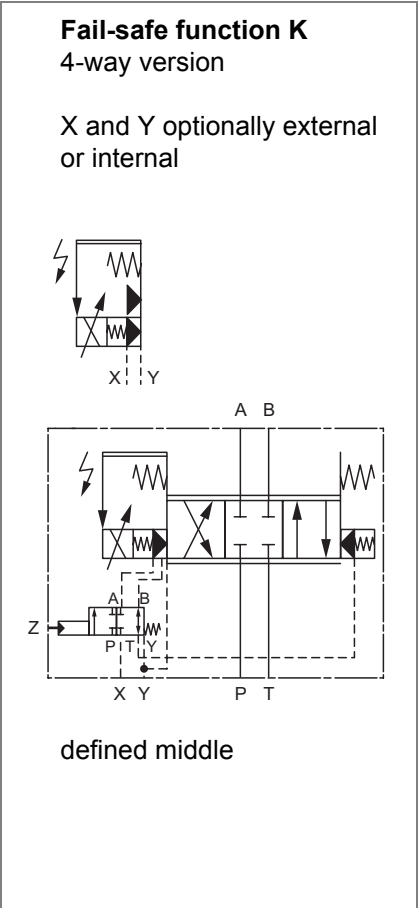
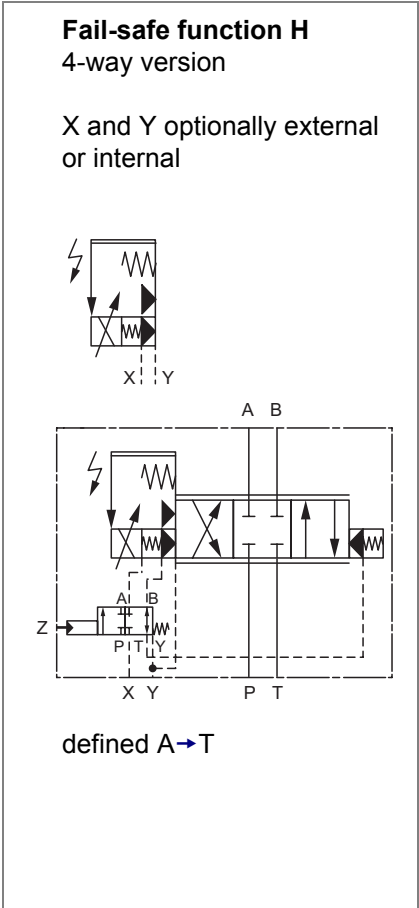

Fig. 65: Installation drawing for D673K (dimensions in mm and (in))

Pos.	Designation	Additional information
1	Type plate	⇒ Fig. 45, page 154
2	Ex type plate	⇒ Fig. 46, page 155

Installation space of the plug connector when mounted: ⇒ Fig. 14, page 67

*) Dimension with fixed cabling of the pilot valve with explosion-proof wiring. If the cabling of the pilot valve makes use of explosion-proof plug connectors, the installation space of the valve increases by 50 mm.



Characteristic curves D673K valves with direct-operated pilot valve D633K



All characteristic curves in the section "Characteristic curves D673K valves with pilot valve D633K" are typical characteristic curves for the D673K valve measured at operating pressure $p_p = 210$ bar (3,046 psi), viscosity of hydraulic fluid $\nu = 32$ mm²/s and temperature of hydraulic fluid $T = 40$ °C (104 °F)

Flow diagram (4-way operation)

⇒ Chap. "4.1 Flow diagram (4-way operation)", page 49

Flow diagram

Flow signal characteristic curve at rated pressure drop $\Delta p_N = 10$ bar, that is, $\Delta p_N = 5$ bar per control land:

Flow signal characteristic curve

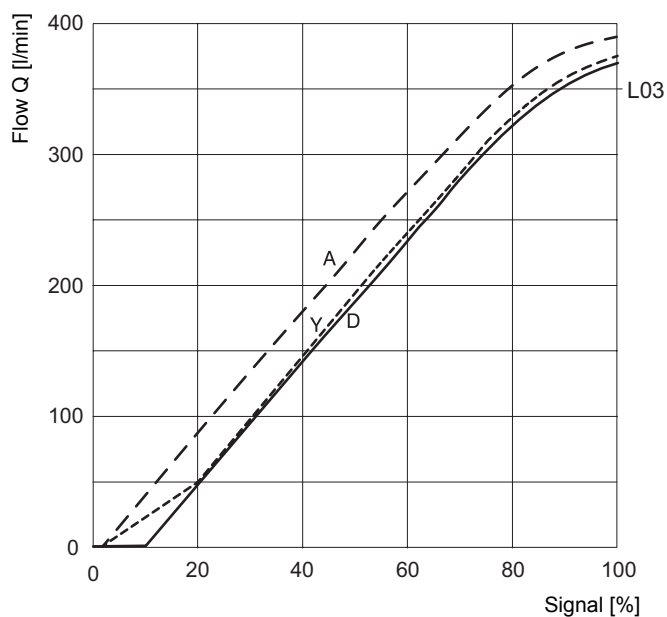

- Spool **A** \approx zero overlap, linear characteristic curve
- Spool **D** 10 % positive overlap, linear characteristic curve
- Spool **Y** \approx zero overlap, kinked characteristic curve
- L03 type: stub shaft spool rated volume flow 350 l/min

Fig. 66: Valve D673K, flow-signal characteristic curve

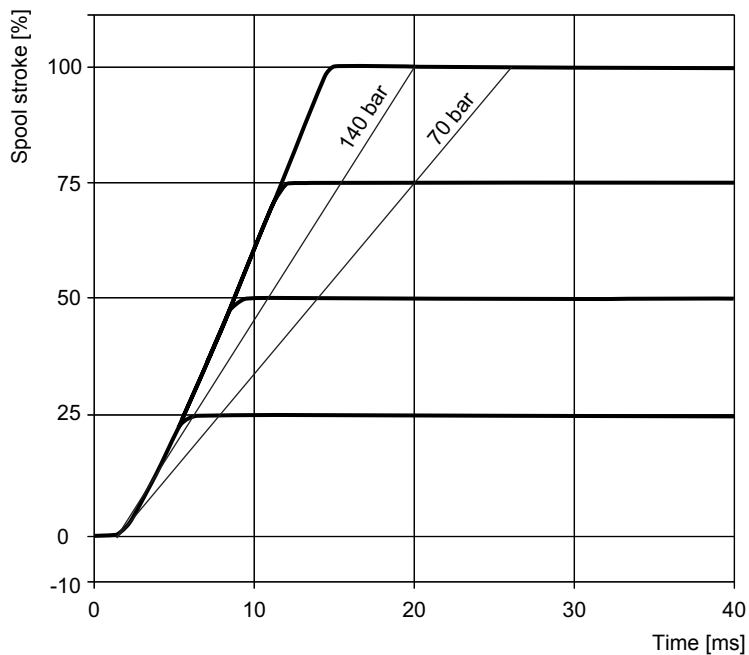

Step response for D673K valves with direct-operated pilot valve D633K, standard

Fig. 67: Step response for D673K valves, standard

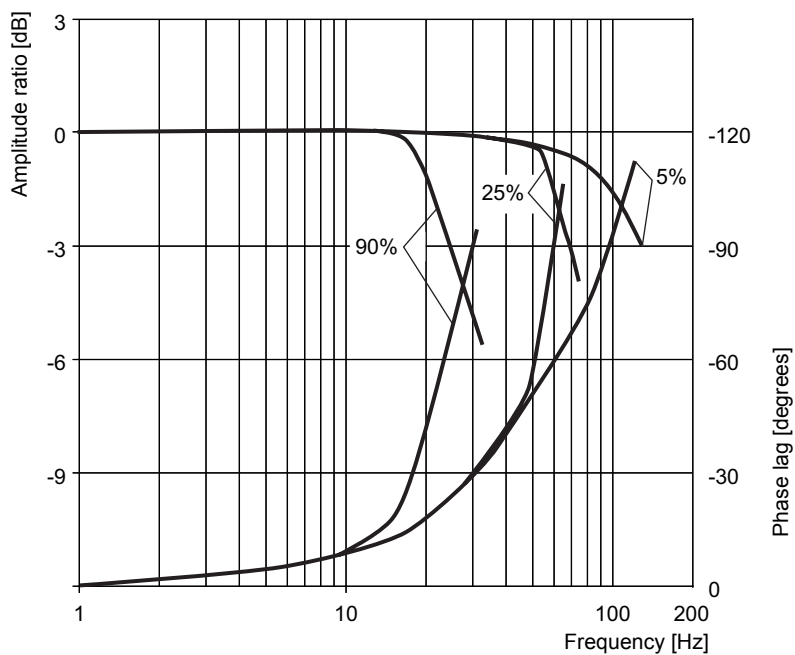

Frequency response for D673K valves with direct-operated pilot valve D633K, standard

Fig. 68: Frequency response for D673K valves, standard

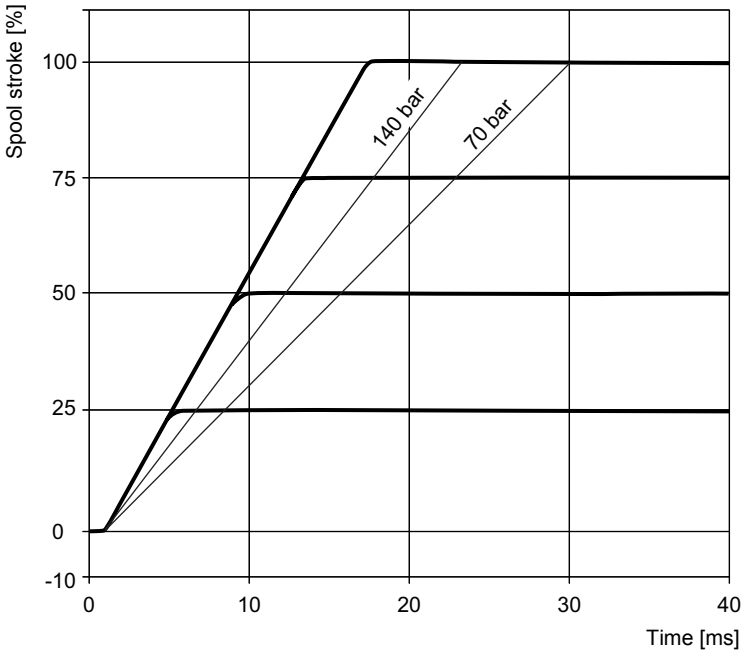

Step response for D673K valves with direct-operated pilot valve D633K, trimmed

Fig. 69: Step response for D673K valves, trimmed

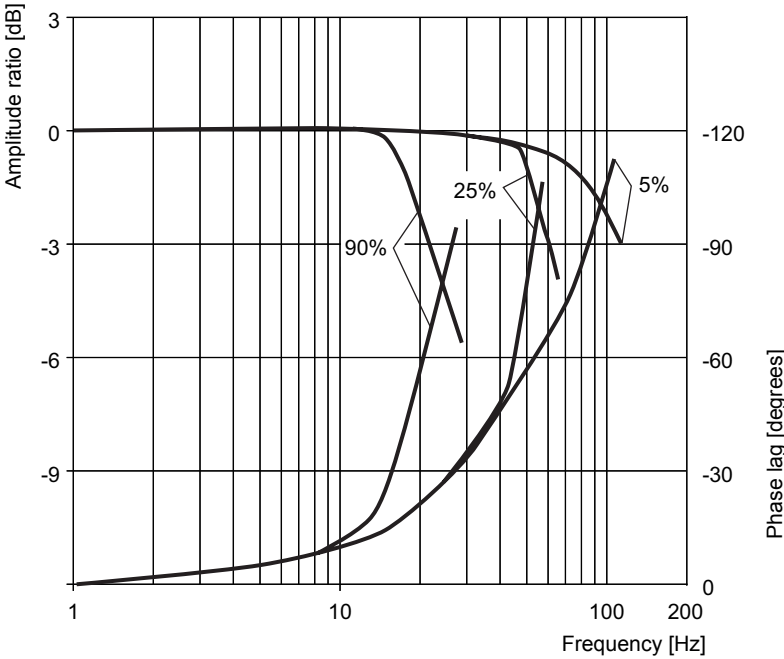

Frequency response for D673K valves with direct-operated pilot valve D633K, trimmed

Fig. 70: Frequency response for D673K valves, trimmed

11.6 Technical data D674K – ISO 4401-08/NG25

The technical data apply for proportional valves in the D674K series

- two-stage, with direct-operated pilot valve D633K
 - ⇒ Chap. "11.6.2 Data D674K with direct-operated pilot valve D633K", page 199
 - ⇒ Chap. "Mounting surface", page 198
 - ⇒ Chap. "Dimensions (installation drawing), with fail-safe F and D", page 201
 - ⇒ Chap. "Valve configurations and hydraulic symbols", page 202
 - ⇒ Chap. "Characteristic curves D674K valves with direct-operated pilot valve D633K", page 205

11.6.1 Mounting surface



If the valve is mounted on the mounting surface, it projects lengthwise (x-axis) over the mounting surface.

Valve dimensions:

⇒ Chap. " Dimensions (installation drawing), with fail-safe F and D", page 201

Technical data for the mounting surface

11.6.1.1 Mounting pattern of mounting surface

The holes in the mounting surface must correspond to ISO 4401-08-08-0-05.

The holes (Fig. 71) apply for the digital proportional valve in the D674K series

- two-stage, with direct-operated pilot valve D633K

Mounting pattern of mounting surface according to ISO 4401-08-08-0-05 D674K

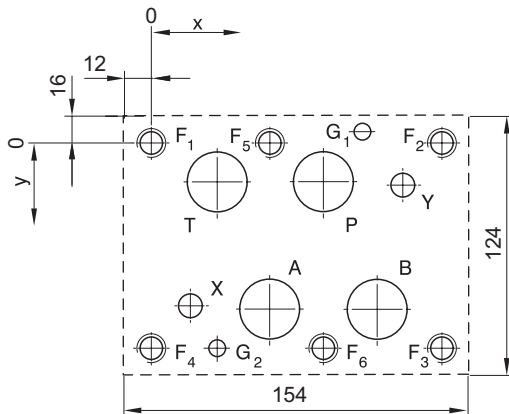

	P	A	T	B	X	Y	G ₂	G ₂	F ₁	F ₂	F ₃	F ₄	F ₂	F ₂
	dia. 32 (1.26)	dia. 32 (1.26)	dia. 32 (1.26)	dia. 32 (1.26)	dia. 11.2 (0.44)	dia. 11.2 (0.44)	dia. 7.5 (0.30)	dia. 7.5 (0.30)	M12	M12	M12	M12	M12	M12
X	77	53.2	29.4	100.8	17.5	112.7	94.5	29.4	0	130.2	130.2	0	53.2	77
Y	17.5	74.6	17.5	74.6	73	19	-4.8	92.1	0	0	92.1	92.1	0	92.1

Fig. 71: Holes in the mounting surface for the D674K series (dimensions in mm and (in))



- For maximum flow, the ports for P, T, A, and B must contrary to the standard be designed with a diameter of 32 mm (1.26 in).
- F₁...F₄ are threaded holes for attachment screws in the mounting surface of the valve.
- G₁ and G₂ are holes for accommodating the transposition-proof pins of the valve.

11.6.2 Data D674K with direct-operated pilot valve D633K

Valve design	Proportional valve, two-stage, with standard spools			General Technical data
Pilot valve	D633K standard or trimmed			
Nominal size and holes	NG25, mounting pattern according to ISO 4401-08-08-0-05 ⇒ Fig. 71, page 198			
Mounting position	In any position, fixed or movable			
Diameter of the connection holes and threads of the fastening holes	P, A, T, B, and X		32 mm	Permissible ambient conditions
	X and Y		11.2 mm	
	F ₁ to F ₆		M10	
	G ₁ and G ₂		7.5 mm	
	⇒ Fig. 71, page 198			
Mass	approx. 26.5 kg (58.4 lb) Valves with fail-safe functions H and K approx. 28 kg (61.7 lb)			
Dimensions	⇒ "Dimensions (installation drawing), with fail-safe F and D", page 201/			
Ambient temperature ¹⁾	for transport/storage ²⁾	recommended	15 °C to 25 °C	
		permissible	–40 °C to 80 °C	
	for operation	(–40 on request)	–20 °C to 60 °C	
	Depending on the certified temperature classes			
Rel. humidity for storage	< 65 % not condensing			
Vibration resistance ³⁾	10 g, 3 axes, Frequency: 10 to 2,000 Hz (according to EN 60068-2-6)			
Shock resistance ³	50 g, 6 directions, half-sine 3 ms (as per EN 60068-2-27)			
Valve configurations	4-way, 3-way, 2/2-way and 2-way operation ⇒ Chap. "3.3.2 Valve configurations and hydraulic symbols", page 34			Hydraulic data
Operating pressure ⁴⁾ of the pilot valve	via T or Y	p _T or p _y +10 bar		
	Operating pressure range X port	10 to 350 bar		
	max. pressure Y port ⁵	70 bar		
Maximum operating pressure range of main stage	Ports P, A, and B		350 bar	
	Port T for Y internal ⁵⁾		70 bar	
	Port T for Y external		350 bar	
Maximum flow Q_{max}	1500 l/min (396 gpm) ⇒ Chap. "4.1 Flow diagram (4-way operation)", page 49			
Rated flow Q_N for Δp _N = 5 bar per control land	550 l/min (145 gpm)			
Leakage flow Main stage Q_L	3.0 l/min (0.79 gpm) (≈ zero overlap)			
Pilot flow static	Pilot valve	standard	0.5 l/min (0.1 gpm)	
		trimmed	0.5 l/min (0.1 gpm)	
Pilot flow at 100 % jump	Pilot valve	standard	35 l/min (9.2 gpm)	
		trimmed	26 l/min (6.9 gpm)	
Hydraulic fluid				
Permissible fluids	Mineral-oil-based hydraulic oil as per DIN 51524-1 1 to 3 and ISO11158 Other fluids on request			
Permissible temperature	(–40 ° on request) –20 ° to 80 ° depending on the certified temperature classes			
Viscosity ν	recommended		15 to 45 mm ² /s	
	permissible		5 to 400 mm ² /s	
Purity class ⁶⁾ , recommended (ISO 4406)	for functional safety < 18/15/12 for life cycle (wear) <17/14/11			

Tab. 39: Technical data D674K with direct-operated pilot valve D633K (part 1 of 2)

Step response time for 0 to 100 % spool stroke	Pilot valve	standard	17 ms	Static and dynamic data
		trimmed	23 ms	
Step response and frequency response ⇒ page 206				
Threshold	< 0.1 %			
Hysteresis	< 0.2 %			
Zero shift at $\Delta T = 55 \text{ K}$	< 1 %			
Manufacturing tolerance	$\pm 10 \%$			
Relative duty cycle	100 %			Electrical data
protection type	IP66 with mounted mating connectors (according to EN 60529)			
Supply voltage	Nominal 24 V (18 to 32 V) DC based on GND. Only use SELV-/PELV power supply according to EN 60204-1 At supply voltages less than 18 V, the valve is rendered in the fail-safe state. ⇒ Chap. "3.2.3 Fail-safe events", page 28			
Max. current consumption static	0.3 A			
Max. current consumption dynamic	1.2 A			
External fuse protection for each valve	1.6 A slow-blowing fuse			
EMC protection requirements	Immunity to interference as per EN 61000-6-2:2005 (evaluation criterion A) Emitted interference as per EN 61000-6-4:2005 (CAN bus and Profibus DP) or as per EN 61000-6-3:2005 (EtherCAT) ⇒ Chap. "11.2 Electromagnetic compatibility (EMC)", page 163			
Connectors	⇒ Chap. "7 Electrical connection", page 61 ⇒ Chap. "7.4.1 Pin assignment of connector X1", page 69			
Triggering electronics	Digital control electronics integrated into the valve			

Tab. 39: Technical data D674K with direct-operated pilot valve D633K (part 2 of 2)

- 1) The ambient temperature and the temperature of the hydraulic fluid influence the temperature of the valve electronics. In order to ensure that the electronic components integrated in the valve last as long as possible, we recommend that the hydraulic fluid be kept at as low a temperature as possible at as low an ambient temperature as possible. A reference temperature is measured in the valve electronics. Fault-free operation is guaranteed up to a reference temperature of 85 °C (185 °F). At reference temperatures over 85 °C (185 °F) a warning is output via the field bus on valves with field bus interfaces. At reference temperatures over 105 °C (221 °F) the valve electronics are deactivated; the valve adopts the 'DISABLED' valve status and thus the mechanical fail-safe state.
⇒ [Chap. "3.2 Safety function/fail-safe", page 25](#)
- 2) **Temperature fluctuations** > 10 °C must be avoided during storage.
- 3) Transportation and storage should be as **vibration- and shock-free** as possible.
- 4) **Hydraulic data** was measured at operating pressure $p_p = 210 \text{ bar}$ (3,046 psi), viscosity of hydraulic fluid $\nu = 32 \text{ mm}^2/\text{s}$ and temperature of hydraulic fluid $T = 40 \text{ °C}$ (104 °F)
⇒ [Chap. "6 Mounting and Connection to the Hydraulic System", page 56](#)
- 5) Pressure peaks up to 210 bar permissible
- 6) The **cleanliness of the hydraulic fluid** has a great effect on functional safety (reliable spool positioning, high resolution) and wear of the spool lands (pressure gain, leakage losses).

Two-stage digital proportional valve D674K series with direct-operated pilot valve D633K

Dimensions (installation drawing), with fail-safe F and D

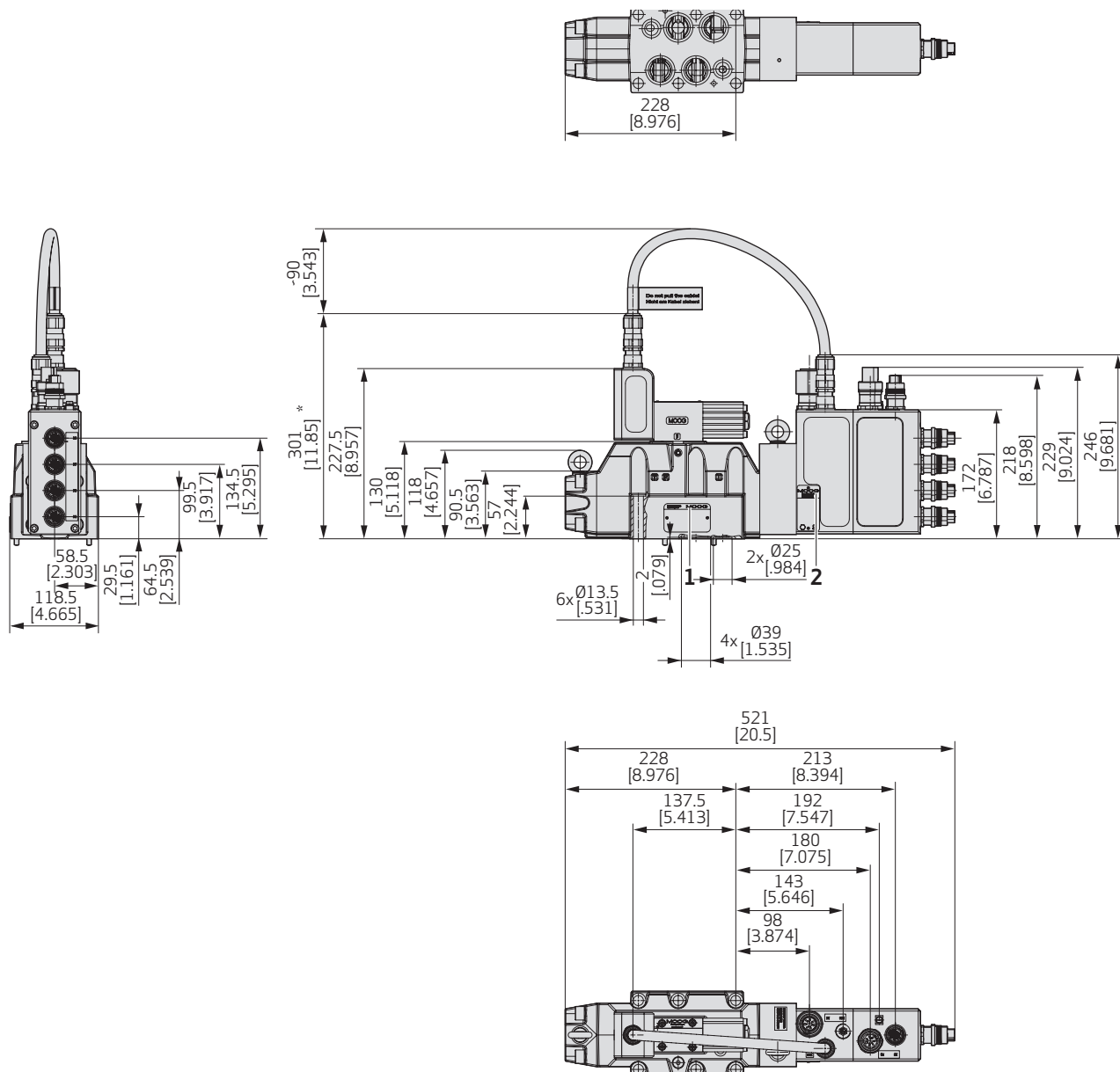

Fig. 72: Installation drawing for D674K (dimensions in mm and (in))

Pos.	Designation	Additional information
1	Type plate	⇒ Fig. 45, page 154
2	Ex type plate	⇒ Fig. 46, page 155

Installation space of the plug connector when mounted: ⇒ Fig. 14, page 67

*) Dimension with fixed cabling of the pilot valve with explosion-proof wiring. If the cabling of the pilot valve makes use of explosion-proof plug connectors, the installation space of the valve increases by 50 mm.

Valve configurations and hydraulic symbols

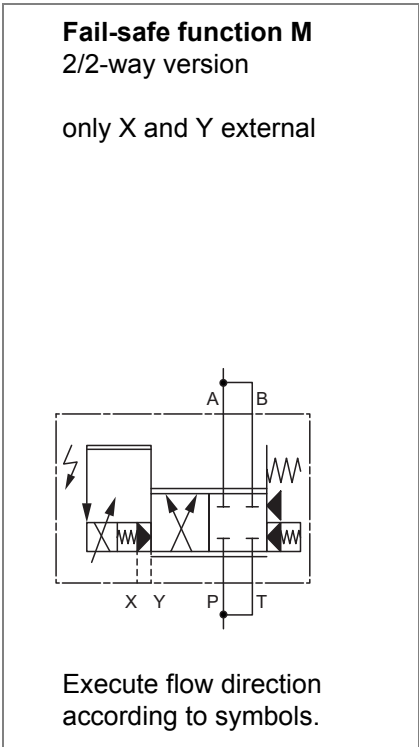
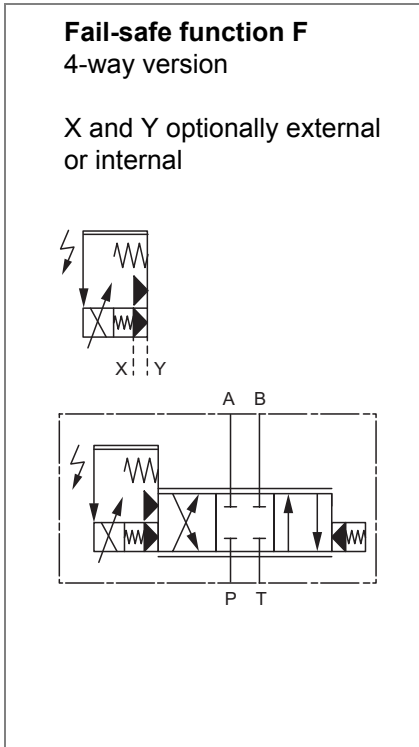

Two-stage digital proportional valve D674K series with direct-operated pilot valve D633K with fail-safe function H and K for applications with safety requirements

Dimensions (installation drawing), mechan./hydr. fail-safe H and K

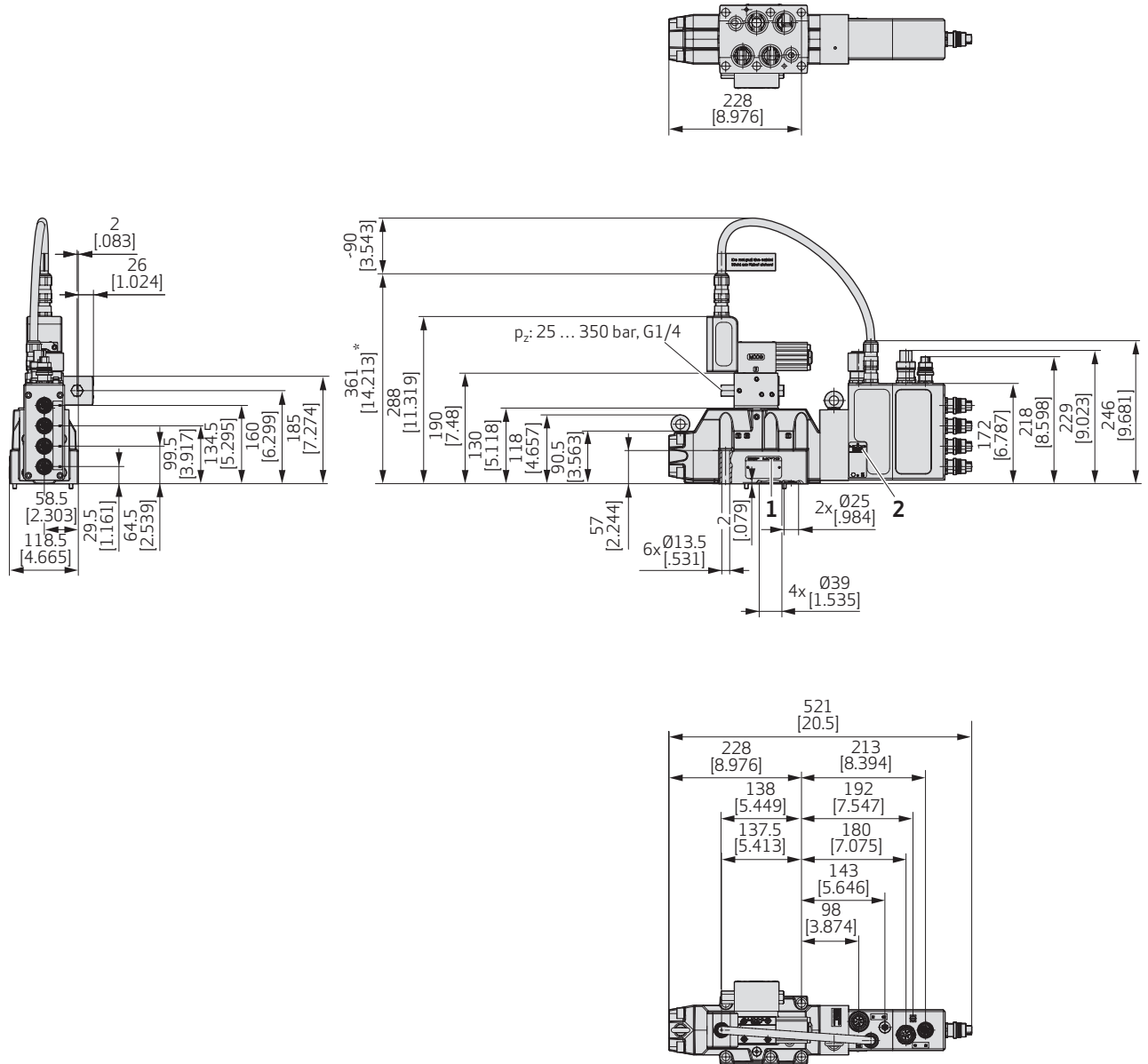
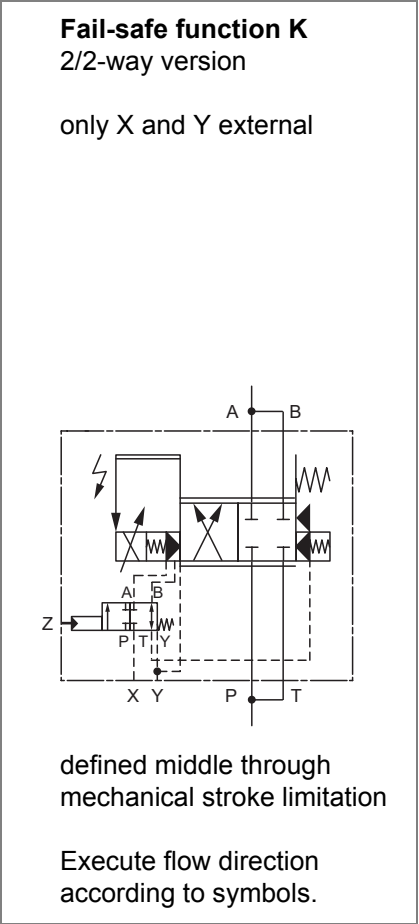
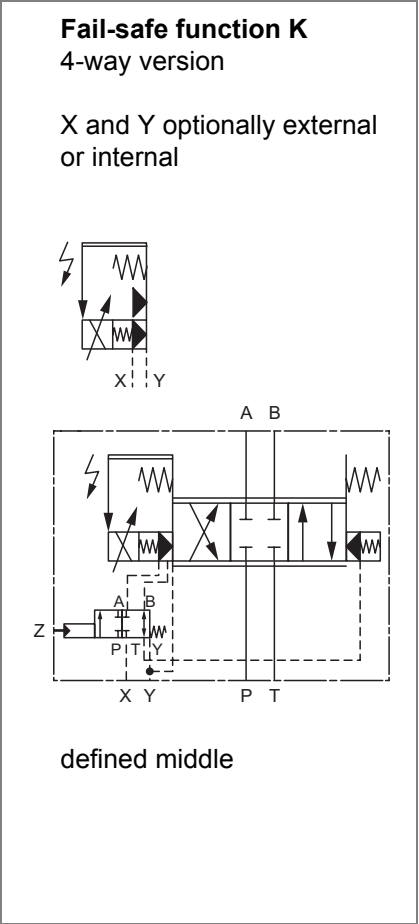
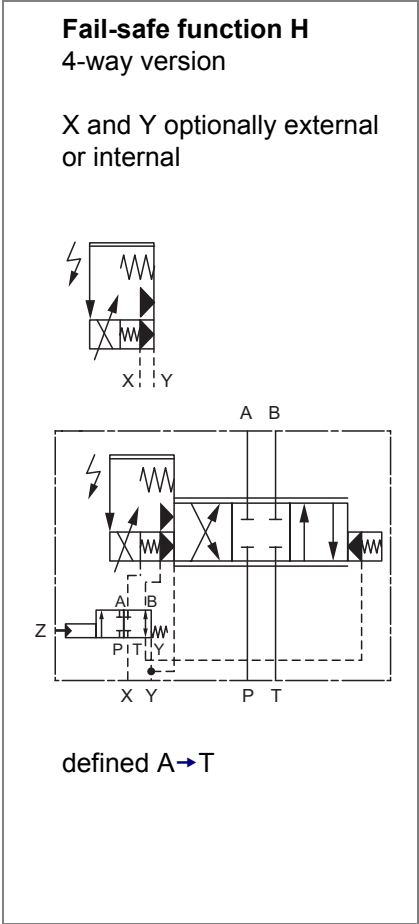

Fig. 73: Installation drawing for D674K (dimensions in mm and (in))

Pos.	Designation	Additional information
1	Type plate	⇒ Fig. 45, page 154
2	Ex type plate	⇒ Fig. 46, page 155

Installation space of the plug connector when mounted: ⇒ Fig. 14, page 67

*) Dimension with fixed cabling of the pilot valve with explosion-proof wiring. If the cabling of the pilot valve makes use of explosion-proof plug connectors, the installation space of the valve increases by 50 mm.



Characteristic curves D674K valves with direct-operated pilot valve D633K



All characteristic curves in the section "Characteristic curves D674K valves with pilot valve D633K" are typical characteristic curves for the D674K valve with pilot valve D633K measured at operating pressure $p_P = 210 \text{ bar}$ (3,046 psi), viscosity of hydraulic fluid $\nu = 32 \text{ mm}^2/\text{s}$ and temperature of hydraulic fluid $T = 40 \text{ }^\circ\text{C}$ (104 $^\circ\text{F}$)

Flow diagram (4-way operation)

⇒ Chap. "4.1 Flow diagram (4-way operation)", page 49

Flow diagram

Flow signal characteristic curve at rated pressure drop $\Delta p_N = 10 \text{ bar}$, that is, $\Delta p_N = 5 \text{ bar}$ per control land:

Flow signal characteristic curve

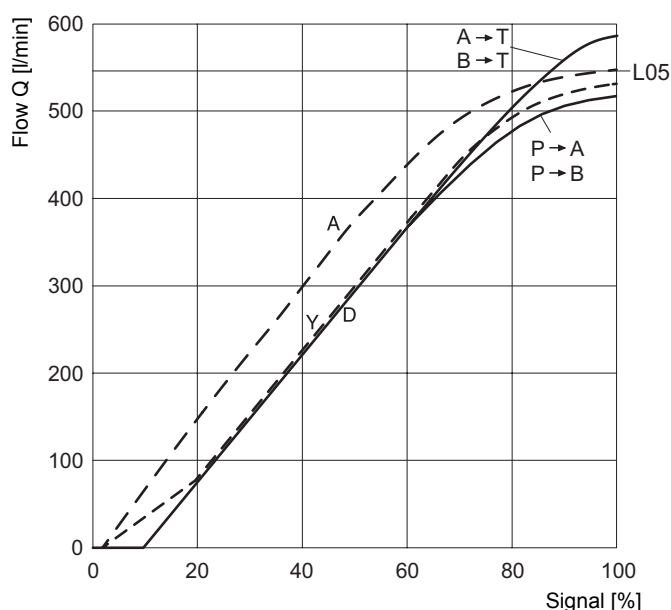

- Spool **A** \approx zero overlap, linear characteristic curve
- Spool **D** 10 % positive overlap, linear characteristic curve
- Spool **Y** \approx zero overlap, kinked characteristic curve
- L05 type: stub shaft spool rated volume flow 550 l/min

Fig. 74: Valve D674K, flow-signal characteristic curve

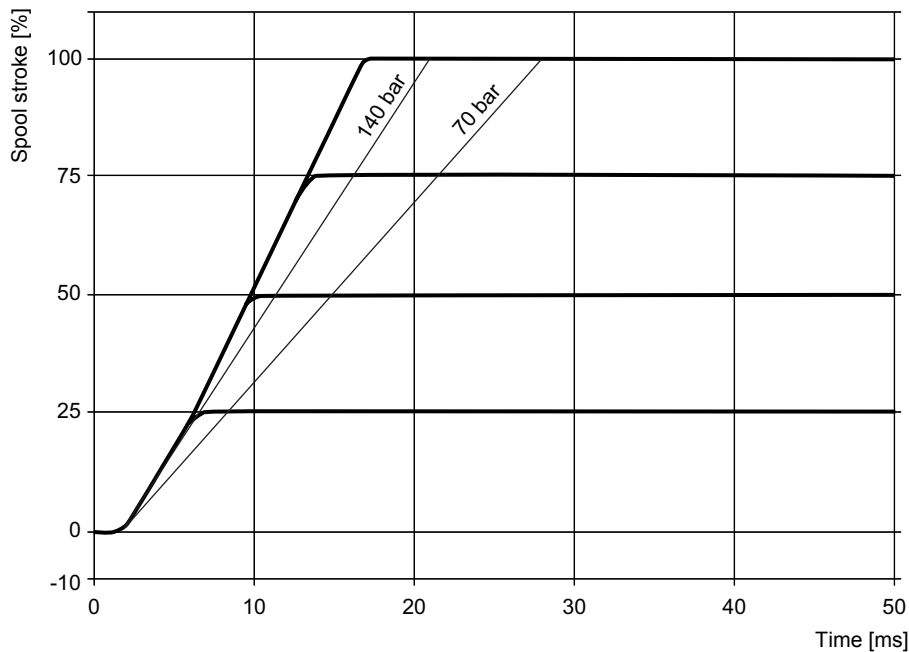

Step response for D674K valves with direct-operated pilot valve D633K, standard

Fig. 75: Step response for D674K valves, standard

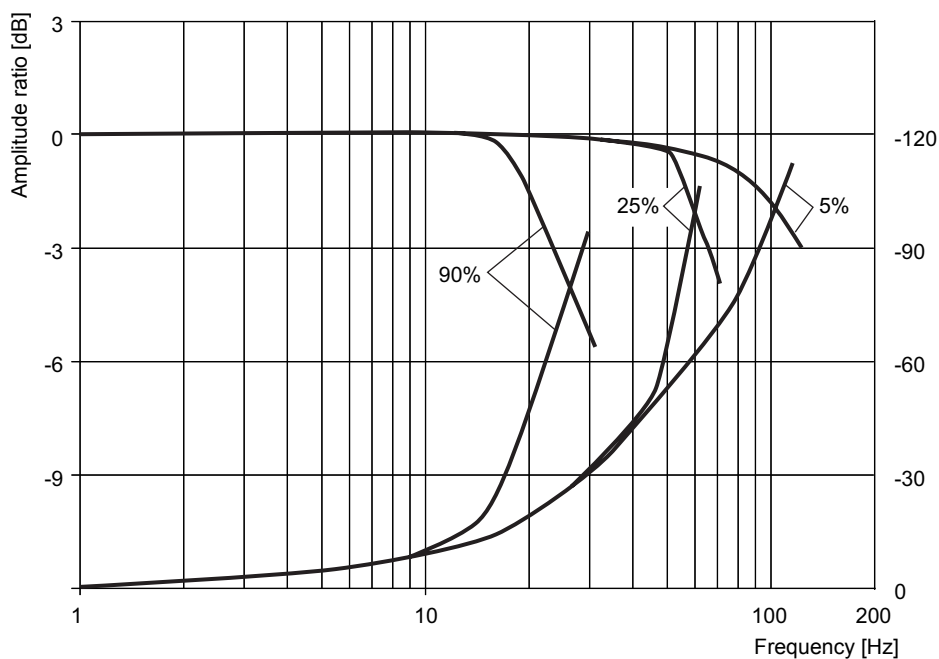

Frequency response for D674K valves with direct-operated pilot valve D633K, standard

Fig. 76: Frequency response for D674K valves, standard

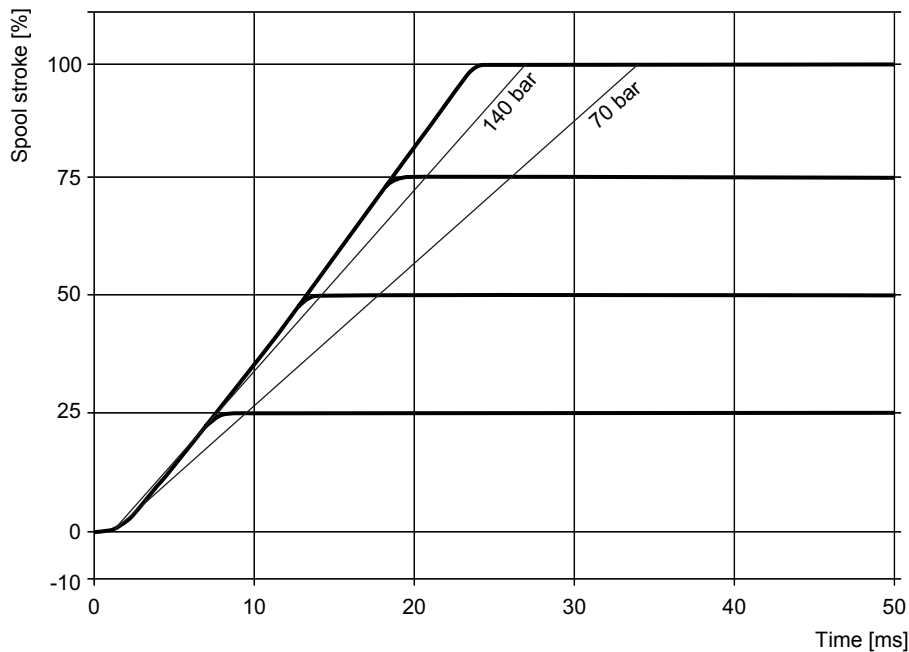

Step response for D674K valves with direct-operated pilot valve D633K, trimmed

Fig. 77: Step response for D674K valves, trimmed

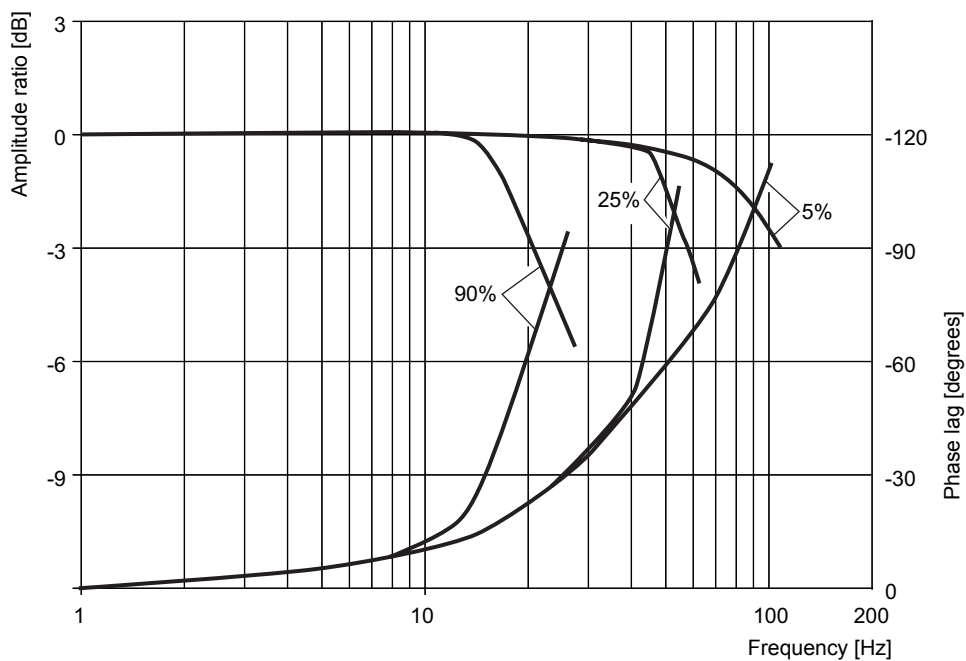

Frequency response for D674K valves with direct-operated pilot valve D633K, trimmed

Fig. 78: Frequency response for D674K valves, trimmed

11.7 Technical data D675K – ISO 4401-10/NG32

The technical data apply for proportional valves in the D675K series

- two-stage, with direct-operated pilot valve D633K
 - ⇒ Chap. "11.7.2 Data D675K with direct-operated pilot valve D633K", page 210
 - ⇒ Chap. "Mounting surface", page 209
 - ⇒ Chap. "Dimensions (installation drawing), with fail-safe F and D", page 212
 - ⇒ Chap. "Valve configurations and hydraulic symbols", page 213
 - ⇒ Chap. "Characteristic curves D675K valves with direct-operated pilot valve D633K", page 216

11.7.1 Mounting surface



If the valve is mounted on the mounting surface, it projects lengthwise (x-axis) over the mounting surface.

Valve dimensions:

⇒ Chap. "Dimensions (installation drawing), with fail-safe F and D", page 212

Technical data for the mounting surface

11.7.1.1 Mounting pattern of mounting surface

The holes in the mounting surface must correspond to ISO 4401-10-09-0-05.

The holes (Fig. 79) apply for the digital proportional valve in the D675K series

- two-stage, with direct-operated pilot valve D633K

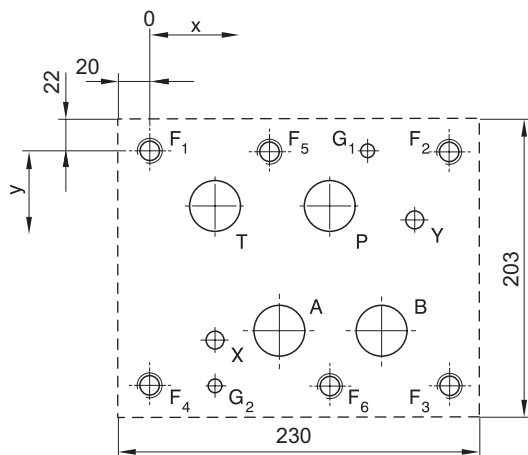

Mounting pattern of mounting surface according to ISO 4401-10-09-0-05 D675K

	P	A	T	B	X	Y	G ₂	G ₂	F ₁	F ₂	F ₃	F ₄	F ₂	F ₂
	dia. 50 (1.97)	dia. 50 (1.97)	dia. 50 (1.97)	dia. 50 (1.97)	dia. 11.2 (0.44)	dia. 11.2 (0.44)	dia. 7.5 (0.30)	dia. 7.5 (0.30)	M12	M12	M12	M12	M12	M12
X	114.3	82.5	41.3	147.6	41.3	168.3	147.6	41.3	0	190.5	190.5	0	76.2	114.3
Y	35	123.8	35	123.8	130.2	44.5	0	158.8	0	0	158.8	158.8	0	158.8

* Dimensions not according to ISO but instead according to DIN 24340

Fig. 79: Holes in the mounting surface for the D675K series (dimensions in mm and (in))



- For maximum flow, the ports for P, T, A, and B must contrary to the standard be designed with a diameter of 50 mm (1.97 in).
- F₁...F₆ are threaded holes for attachment screws in the mounting surface of the valve.
- G₁ and G₂ are threaded holes for accommodating the transposition-proof pins of the valve.
- The position of the attached guard pin is according to DIN 24340.
The hole G1 according to ISO is 138.6 mm and is also drilled in the valve body.

11.7.2 Data D675K with direct-operated pilot valve D633K

Valve design	Proportional valve, two-stage, with standard spools			General Technical data
Pilot valve	D633K standard or trimmed			
Nominal size and holes	NG32, mounting pattern according to ISO 4401-10-09-0-05 ⇒ Fig. 79, page 209			
Mounting position	In any position, fixed or movable			
Diameter of the ports and threads of the fastening holes	P, A, T, and B		50 mm	Permissible ambient conditions
	X and Y		11.2 mm	
	F ₁ to F ₆		M20	
	G ₁ and G ₂		7.5 mm	
	⇒ Fig. 79, page 209			
Mass	approx. 76.5 kg (168.7 lb) Valves with fail-safe functions H and K approx. 78 kg (172 lb)			
Dimensions	⇒ Chap. "Dimensions (installation drawing), with fail-safe F and D", page 212			
Ambient temperature ¹⁾	for transport/storage ²⁾	recommended	15 °C to 25 °C	
		permissible	–40 °C to 80 °C	
	for operation	(–40 on request)	–20 °C to 60 °C	
	Depending on the certified temperature classes			
Rel. humidity for storage	< 65 % not condensing			
Vibration resistance ³⁾	10 g, 3 axes, Frequency: 10 to 2,000 Hz (according to EN 60068-2-6)			
Shock resistance ³	50 g, 6 directions, half-sine 3 ms (as per EN 60068-2-27)			
Valve configurations	4-way, 3-way, 2/2-way and 2-way operation ⇒ Chap. "3.3.2 Valve configurations and hydraulic symbols", page 34			Hydraulic data
Operating pressure ⁴⁾ of the pilot valve	via T or Y	p _T or p _y +10 bar		
	Operating pressure range X port	10 to 350 bar		
	max. pressure Y port ⁵	50 bar		
Maximum operating pressure range of main stage	Ports P, A, and B		350 bar	
	Port T for Y internal ⁵⁾		50 bar	
	Port T for Y external		350 bar	
Maximum flow Q_{max}	3600 l/min (951 gpm) ⇒ Chap. "4.1 Flow diagram (4-way operation)", page 49			
Rated flow Q_N for Δp _N = 5 bar per control land	Standard and trimmed 1000 / 1500 l/min (264 /396 gpm) (depending on the series variant ⇒ Chap. "Type designation", "Digit 2, rated flow Q_N", page 157)			
Leakage flow Main stage Q_L	7.0 l/min (1.85 gpm) (≈ zero overlap)			
Pilot flow static	Pilot valve	standard and trimmed	1.4 l/min (0.37 gpm)	
Pilot flow at 100 % jump	Pilot valve	standard trimmed	35 l/min (9.25 gpm) 26 l/min (6.9 gpm)	
Hydraulic fluid				
Permissible fluids	Mineral-oil-based hydraulic oil as per DIN 51524-1 1 to 3 and ISO11158 Other fluids on request			
Permissible temperature	(–40 ° on request) –20 ° to 80 ° depending on the certified temperature classes			
Viscosity ν	recommended		15 to 45 mm ² /s	
	permissible		5 to 400 mm ² /s	
Purity class ⁶⁾ , recommended (ISO 4406)	for functional safety < 18/15/12 for life cycle (wear) <17/14/11			

Tab. 40: Technical data D675K with direct-operated pilot valve D633K (part 1 of 2)

Step response time for 0 to 100 % spool stroke	standard	with 1000 l/min rated flow with 1500 l/min rated flow	30 ms 37 ms	Static and dynamic data
	trimmed	with 1000 l/min rated flow with 1500 l/min rated flow	35 ms 43 ms	
Step response and frequency response ⇒ page 218				
Threshold	< 0.1 %			
Hysteresis	< 0.2 %			
Zero shift at $\Delta T = 55 \text{ K}$	< 2 %			
Manufacturing tolerance	$\pm 10 \%$			
Relative duty cycle	100 %			
protection type	IP66 with mounted mating connectors (according to EN 60529)			
Supply voltage	Nominal 24 V (18 to 32 V) DC based on GND. Only use SELV-/PELV power supply according to EN 60204-1 At supply voltages less than 18 V, the valve is rendered in the fail-safe state. ⇒ Chap. "3.2.3 Fail-safe events", page 28			
Max. current consumption static	0.3 A			Electrical data
Max. current consumption dynamic	1.2 A			
External fuse protection for each valve	1.6 A slow-blowing fuse			
EMC protection requirements	Immunity to interference as per EN 61000-6-2:2005 (evaluation criterion A) Emitted interference as per EN 61000-6-4:2005 (CAN bus and Profibus DP) or as per EN 61000-6-3:2005 (EtherCAT) ⇒ Chap. "11.2 Electromagnetic compatibility (EMC)", page 163			
Connectors	⇒ Chap. "7 Electrical connection", page 61 ⇒ Chap. "7.4.1 Pin assignment of connector X1", page 69			
Triggering electronics	integrated into the valve			

Tab. 40: Technical data D675K with direct-operated pilot valve D633K (part 2 of 2)

- 1) The ambient temperature and the temperature of the hydraulic fluid influence the temperature of the valve electronics. In order to ensure that the electronic components integrated in the valve last as long as possible, we recommend that the hydraulic fluid be kept at as low a temperature as possible at as low an ambient temperature as possible. A reference temperature is measured in the valve electronics. Fault-free operation is guaranteed up to a reference temperature of 85 °C (185 °F). At reference temperatures over 85 °C (185 °F) a warning is output via the field bus on valves with field bus interfaces. At reference temperatures over 105 °C (221 °F) the valve electronics are deactivated; the valve adopts the 'DISABLED' valve status and thus the mechanical fail-safe state.
⇒ [Chap. "3.2 Safety function/fail-safe", page 25](#)
- 2) **Temperature fluctuations** > 10 °C must be avoided during storage.
- 3) Transportation and storage should be as **vibration- and shock-free** as possible.
- 4) **Hydraulic data** was measured at operating pressure $p_p = 210 \text{ bar}$ (3,046 psi), viscosity of hydraulic fluid $\nu = 32 \text{ mm}^2/\text{s}$ and temperature of hydraulic fluid $T = 40 \text{ °C}$ (104 °F)
⇒ [Chap. "6 Mounting and Connection to the Hydraulic System", page 56](#)
- 5) **Pressure peaks** up to 210 bar permissible
- 6) The **cleanliness of the hydraulic fluid** has a great effect on functional safety (reliable spool positioning, high resolution) and wear of the spool lands (pressure gain, leakage losses).

Two-stage digital proportional valve D675K series with direct-operated pilot valve D633K

Dimensions (installation drawing), with fail-safe F and D

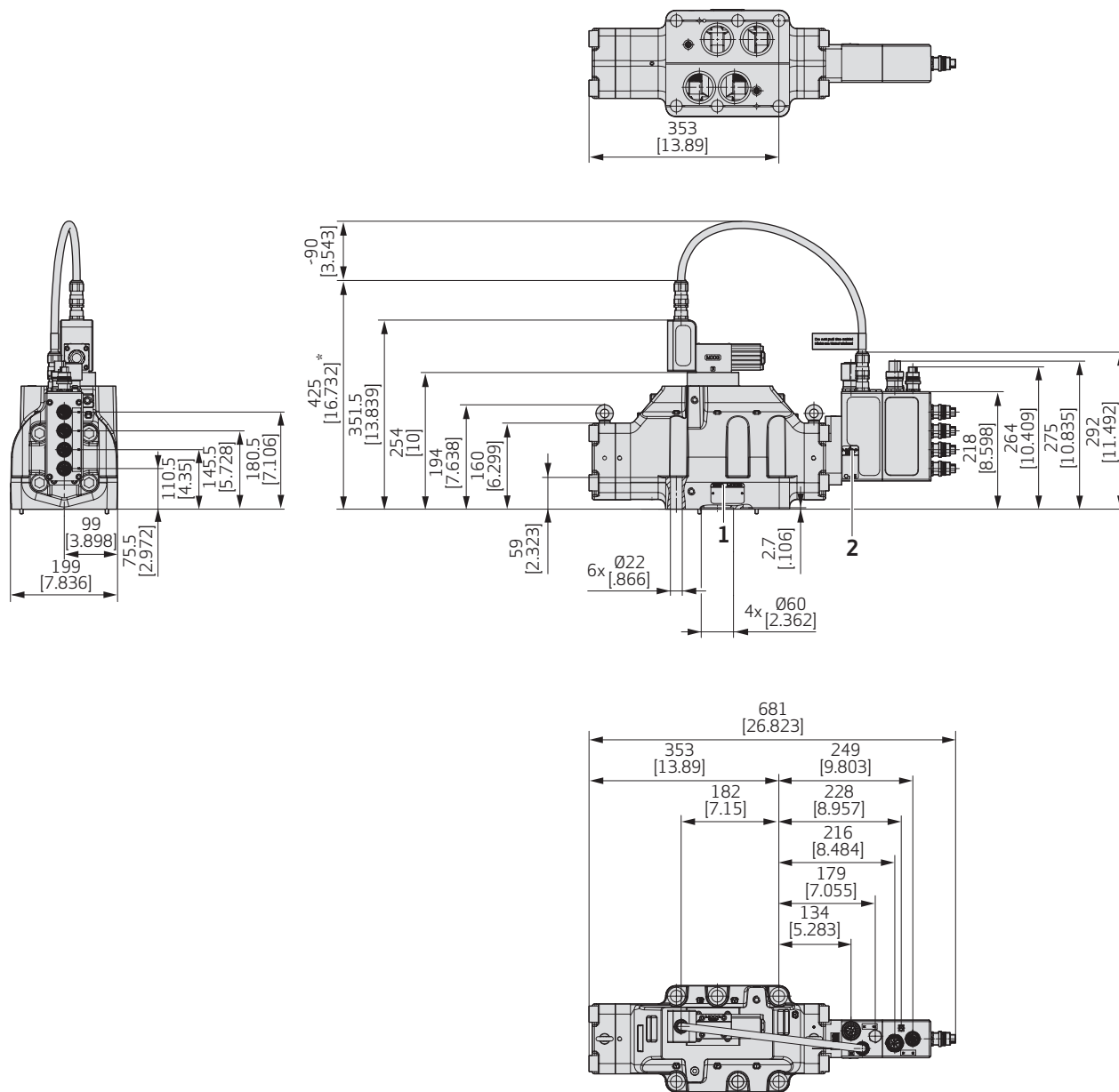

Fig. 80: Installation drawing for D675K (dimensions in mm and (in))

Pos.	Designation	Additional information
1	Type plate	⇒ Fig. 45, page 154
2	Ex type plate	⇒ Fig. 46, page 155

Installation space of the plug connector when mounted: ⇒ Fig. 14, page 67

*) Dimension with fixed cabling of the pilot valve with explosion-proof wiring. If the cabling of the pilot valve makes use of explosion-proof plug connectors, the installation space of the valve increases by 50 mm.

Valve configurations and hydraulic symbols

Fail-safe function F
4-way version

X and Y optionally external
or internal

A B
P T

Fail-safe function M
2/2-way version

only X and Y external

A B
X Y P T

Execute flow direction
according to symbols.

Two-stage digital proportional valve D675K series with direct-operated pilot valve D633K with fail-safe function H and K for applications with safety requirements

Dimensions (installation drawing), mechan./hydr. fail-safe H and K

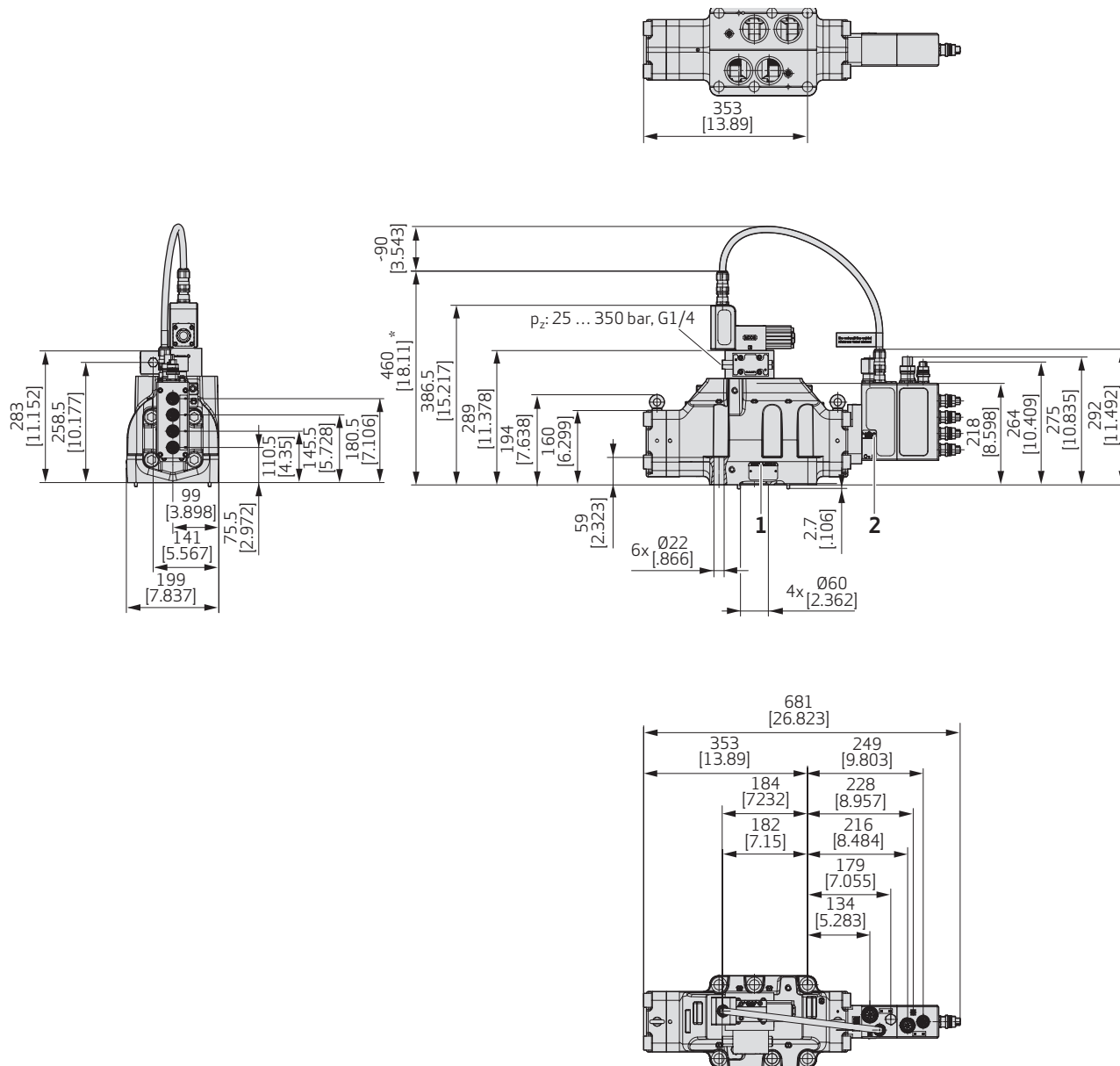
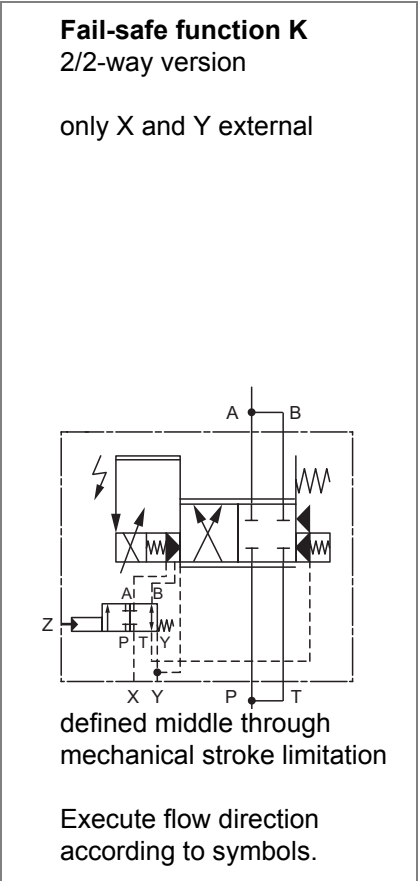
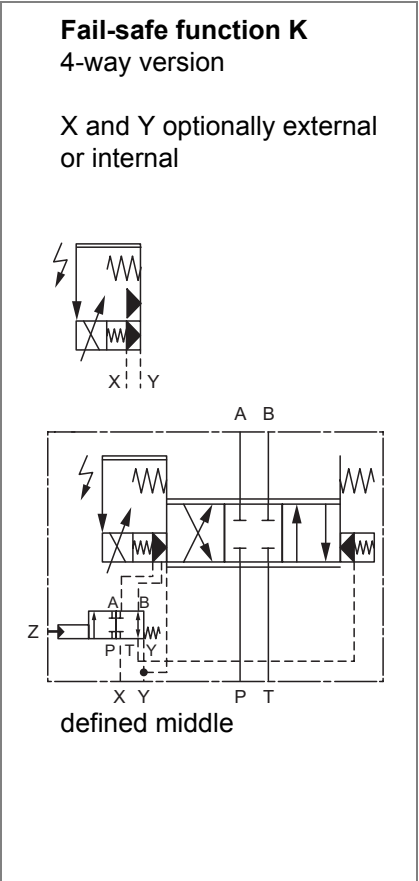
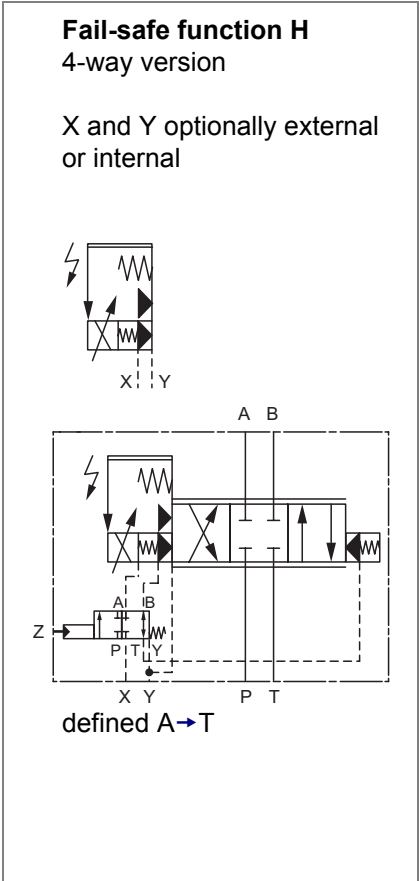

Fig. 81: Installation drawing for D675K (dimensions in mm and (in))

Pos.	Designation	Additional information
1	Type plate	⇒ Fig. 45, page 154
2	Ex type plate	⇒ Fig. 46, page 155

Installation space of the plug connector when mounted: ⇒ Fig. 14, page 67

*) Dimension with fixed cabling of the pilot valve with explosion-proof wiring. If the cabling of the pilot valve makes use of explosion-proof plug connectors, the installation space of the valve increases by 50 mm.



Characteristic curves D675K valves with direct-operated pilot valve D633K



All characteristic curves in the section "Characteristic curves D675K valves with pilot valve D633K" are typical characteristic curves for the D675K valve with pilot valve D633K measured at operating pressure $p_P = 210 \text{ bar}$ (3,046 psi), viscosity of hydraulic fluid $\nu = 32 \text{ mm}^2/\text{s}$ and temperature of hydraulic fluid $T = 40 \text{ }^\circ\text{C}$ (104 $^\circ\text{F}$)

Flow diagram (4-way operation)

⇒ Chap. "4.1 Flow diagram (4-way operation)", page 49

Flow diagram

Flow signal characteristic curve at rated pressure drop $\Delta p_N = 10 \text{ bar}$, that is, $\Delta p_N = 5 \text{ bar}$ per control land:

Flow signal characteristic curve

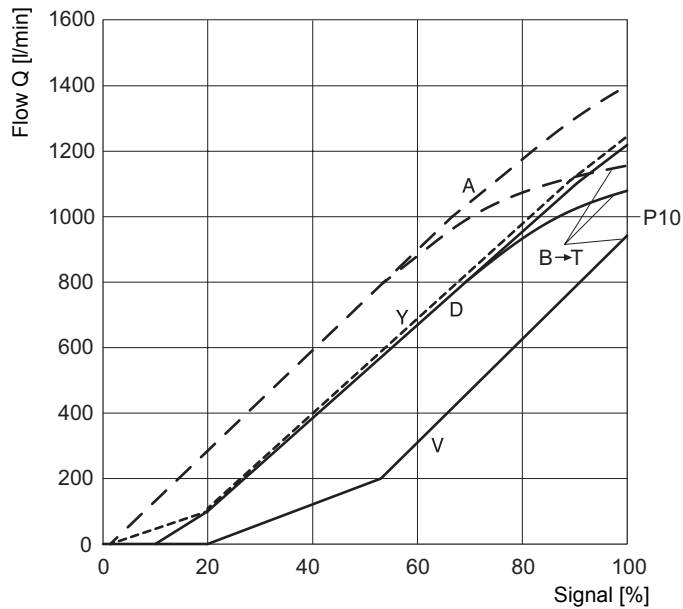

- Spool **A** \approx zero overlap, linear characteristic curve
- Spool **D** 10 % positive overlap, linear characteristic curve
- Spool **V** 20 % positive overlap, kinked characteristic curve
- Spool **Y** \approx zero overlap, kinked characteristic curve
- P10 type: standard spool rated flow 1000 l/min

Fig. 82: Valve D675K, flow-signal characteristic curve 1000 l/min

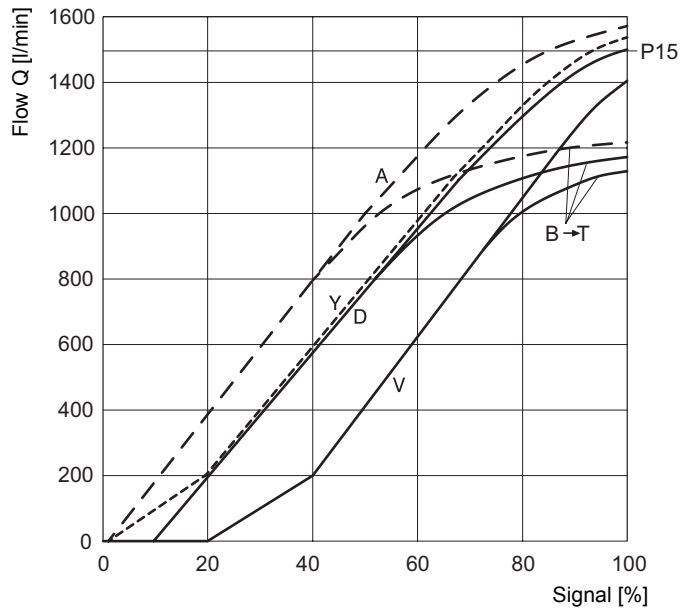

- Spool **A** ≈ zero overlap, linear characteristic curve
- Spool **D** 10 % positive overlap, linear characteristic curve
- Spool **V** 20 % positive overlap, kinked characteristic curve
- Spool **Y** ≈ zero overlap, kinked characteristic curve
- P15 type: standard spool rated flow 1500 l/min

Fig. 83: Valve D675K, flow-signal characteristic curve 1500 l/min

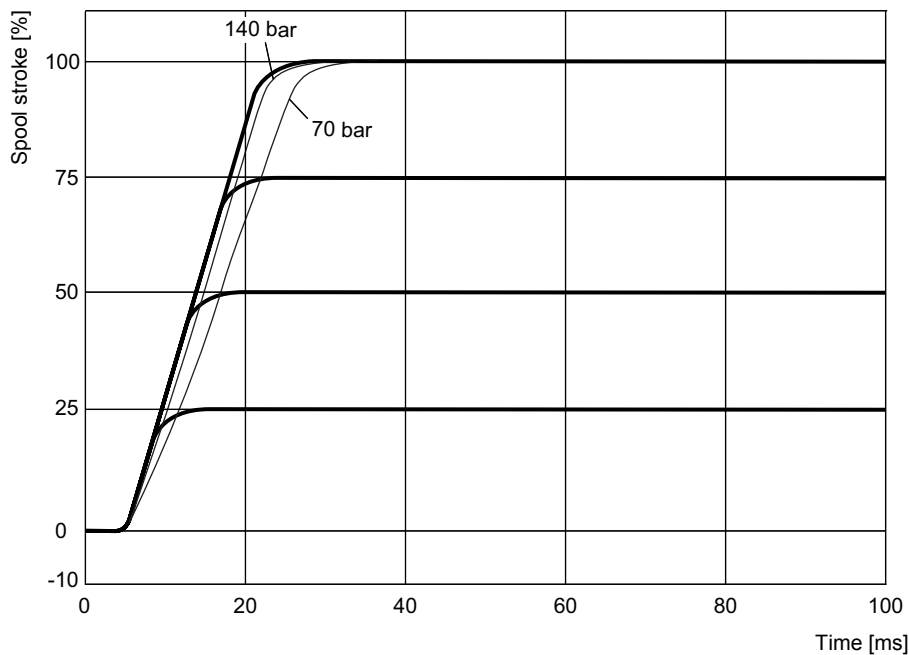

Step response for D675K valves with direct-operated pilot valve D633K, standard, stub shaft spool K10

Fig. 84: Step response for D675K valves, standard, stub shaft spool K10

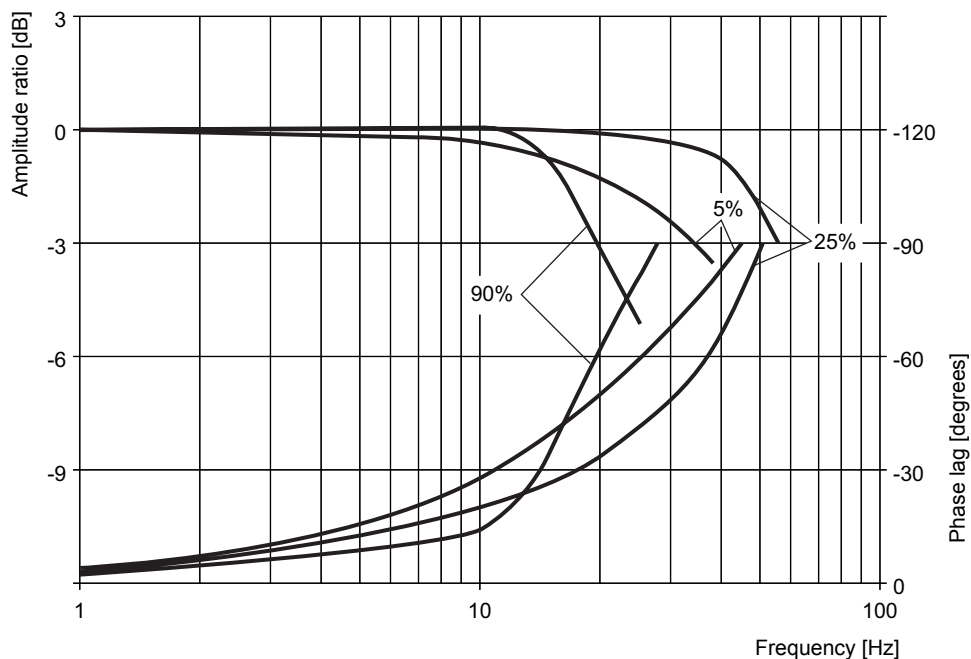

Step response for D675K valves with direct-operated pilot valve D633K, standard, stub shaft spool K10

Fig. 85: Frequency response for D675K valves, standard, stub shaft spool K10

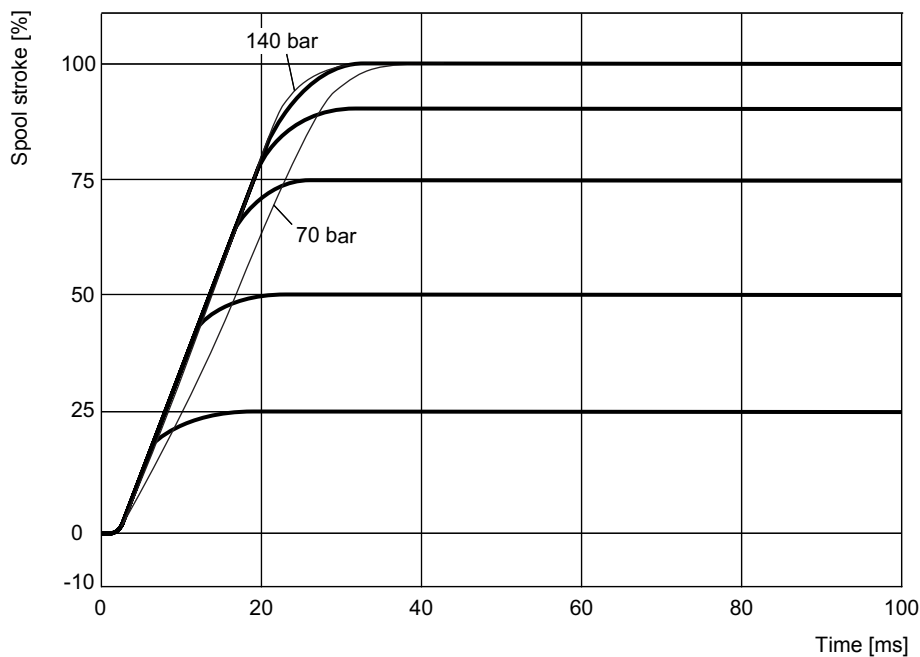

Step response for D675K valves with direct-operated pilot valve D633K, trimmed, stub shaft spool K10

Fig. 86: Step response for D675K valves, trimmed, stub shaft spool K10

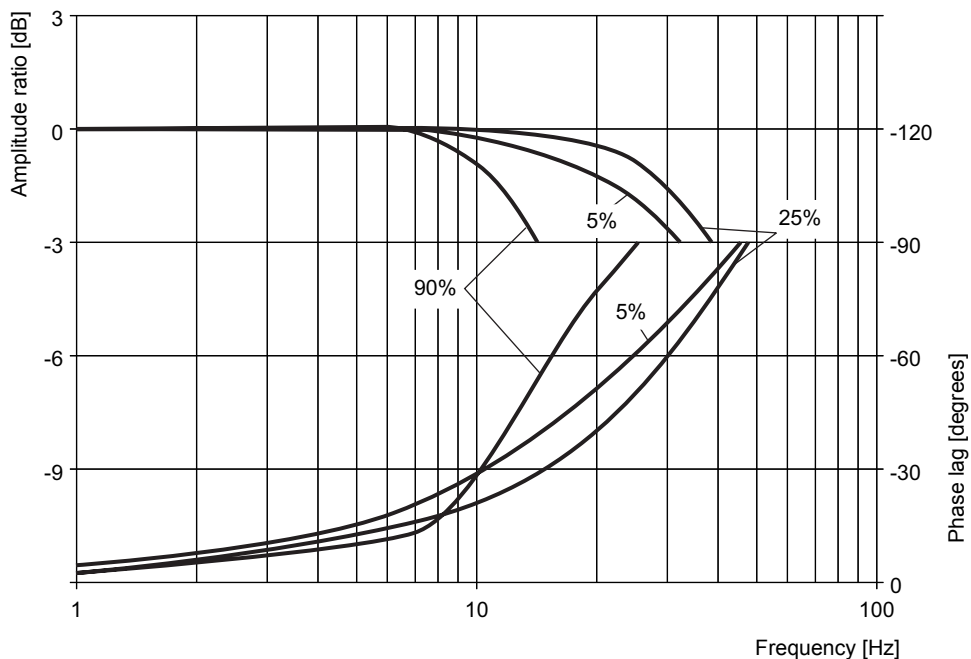

Frequency response for D675K valves with direct-operated pilot valve D633K, trimmed, stub shaft spool K10

Fig. 87: Frequency response for D675K valves, trimmed, stub shaft spool K10

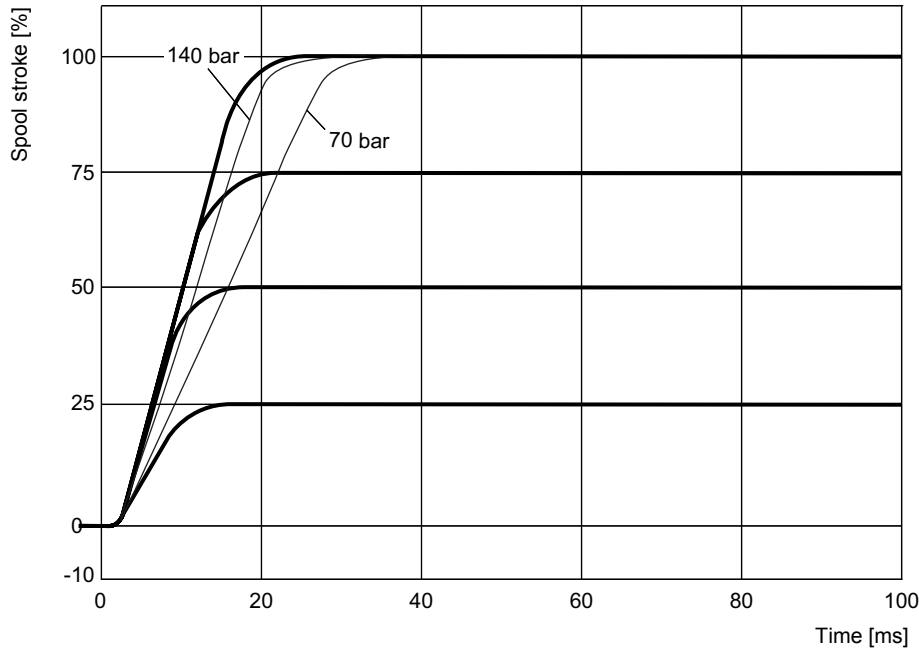

Step response for D675K valves with direct-operated pilot valve D633K, standard, stub shaft spool K15

Fig. 88: Step response for D675K valves, standard, stub shaft spool K15

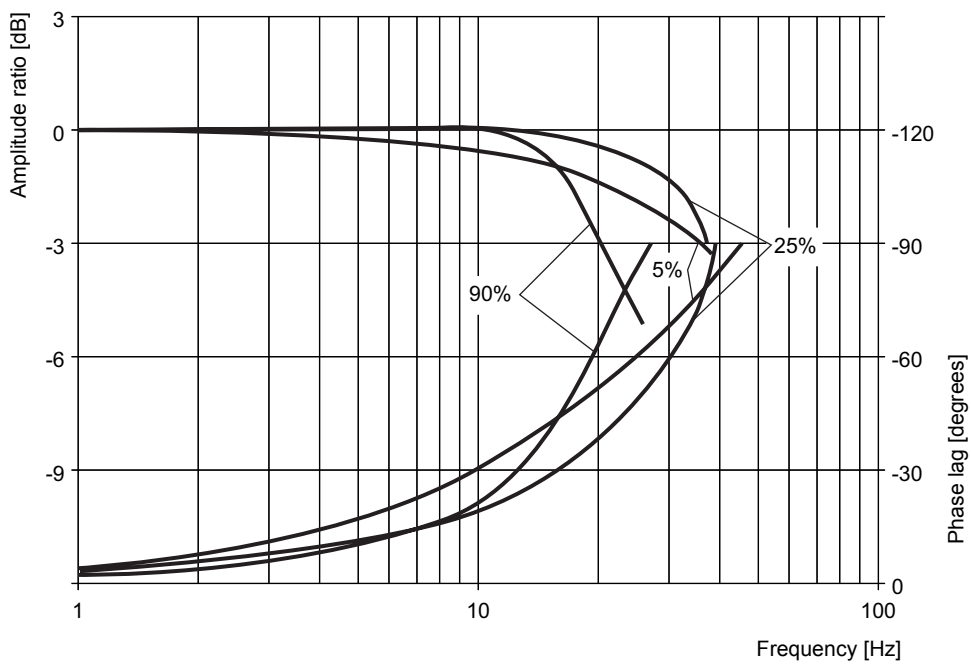

Frequency response for D675K valves with direct-operated pilot valve D633K, standard, stub shaft spool K15

Fig. 89: Frequency response for D675K valves, standard, stub shaft spool K15

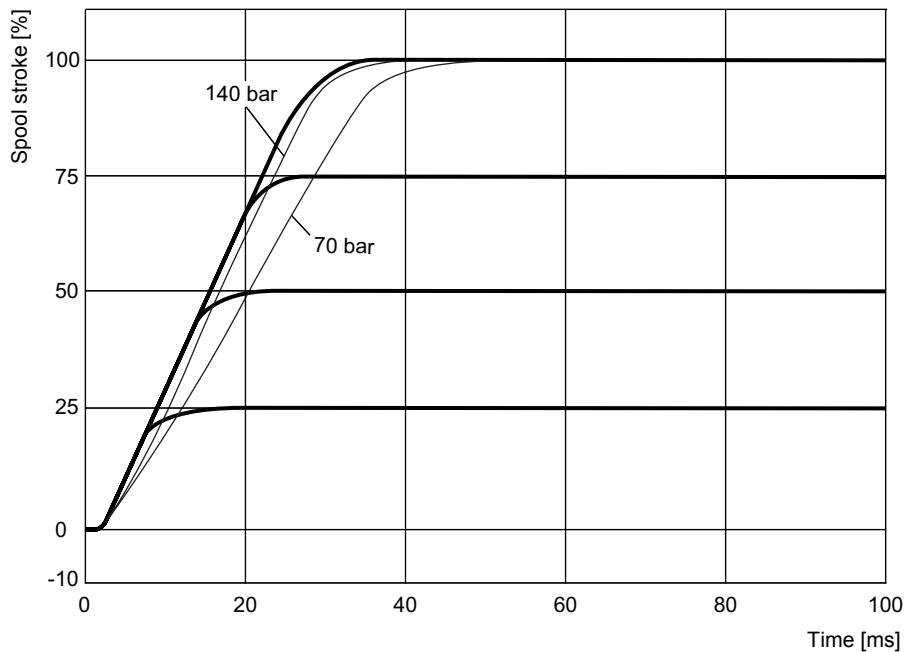

Step response for D675K valves with direct-operated pilot valve D633K, trimmed, stub shaft spool K15

Fig. 90: Step response for D675K valves, trimmed, stub shaft spool K15

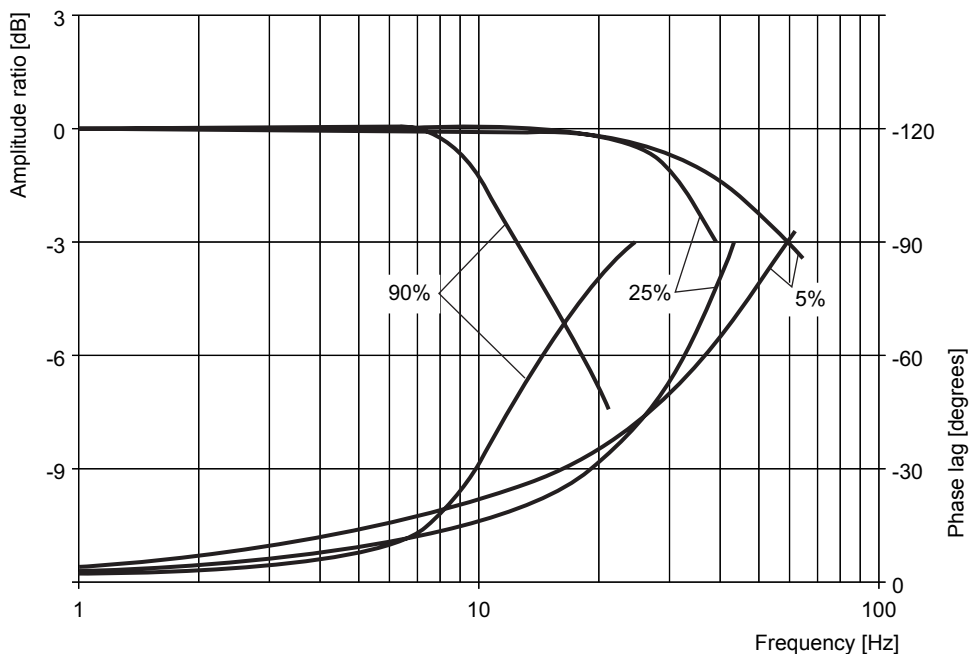

Frequency response for D675K valves with direct-operated pilot valve D633K, trimmed, stub shaft spool K15

Fig. 91: Frequency response for D675K valves, trimmed, stub shaft spool K15

12 Accessories, Spare Parts, and Tools

CAUTION



Danger of personal and property damage due to defective accessories and defective spare parts!

Unsuitable or defective accessories or unsuitable or defective spare parts may cause damage, malfunctions or failure of the valve or the machine.

- ▶ Use only original accessories and original spare parts.
- ▶ ⇒ [Chap. "12 Accessories, Spare Parts, and Tools", page 222](#)
- ▶ Warranty and liability claims for personal injury and damage to property are among other things excluded if they are caused by the use of unsuitable or defective accessories or unsuitable or defective spare parts.
- ▶ ⇒ [Chap. "1.8 Warranty and liability", page 11](#)

12.1 Accessories for valves in the D67XK series



The accessories are Not included in scope of delivery
⇒ [Chap. "5.2 Scope of delivery of the valve", page 54](#)



Cables of the connection cable that are not used must be insulated or insulated and placed in the control cabinet.

Item designation	Number required	Comments	Item number
Item name: Adapter cable M8-M12, 2 m (not approved for hazardous areas)	1		CA40934-001
USB start-up module (for service connector X10) not approved for use in hazardous areas	1		C43094-001
Configuration/start-up cable, 2 m not approved for hazardous areas	1		TD3999-137
SELV/PELV power pack (24 V DC, 10 A) not approved for hazardous areas	1		D137-003-001
Power supply cord, 2 m (not approved for hazardous areas)	1		B95924-002
Configuration / commissioning software (Moog Valve and Pump Configuration Software)	1		B99104
Present documentation			
User manual type series D67XK, German	1		CDS29588-002
User manual type series D67XK, English	1		CDS29588-en
M8-M12 adapter cable	1		CA40934-001
Mating connector X1	1	Without cable, plug exlink, Fa. CEAG	CB22154-001
Mating connector X2	1	Without cable, plug exlink, Fa. CEAG	CB22150-001
Mating connector X5, X6, X7	3	Without cable, plug exlink, Fa. CEAG	CB22148-001
Mating connector CAN X3, X4	2	Without cable, plug exlink, Fa. CEAG	CB22142-001
Mating connector Profibus X3, X4	2	Without cable, plug exlink, Fa. CEAG	CB22145-001
Mating connector Ethercat X3, X4	2	Without cable, plug exlink, Fa. CEAG	CB22152-001

Tab. 41: Accessories and tools for all proportional valves in the D67XK series (part 1 of 2)

Item designation	Number required	Comments	Item number
Connection cable X1	1	Mud-resistant cable with plug exlink, Fa. CEAG, cable length 20 m	CB22155-001
Connection cable X2	1	Mud-resistant cable with plug exlink, Fa. CEAG, cable length 20 m	CB22151-001
Connection cable CAN X3, X4	2	Mud-resistant cable with plug exlink, Fa. CEAG, cable length 20 m	CB22346-001
Connection cable CAN X3, X4	1	Mud-resistant cable with plug exlink, Fa. CEAG, cable length 20 m With integrated terminal resistor - this cable can only be used to connect the last valve in the fieldbus chain	CB22144-001
Connection cable CAN X3, X4	2	Mud-resistant cable with plug exlink, Fa. CEAG, cable length 20 m This cable must be used if 24 V supply should be looped over the CAN bus. The terminal resistor must be effected externally	CB22143-001
Connection cable Profibus X3, X4	2	Mud-resistant cable with plug exlink, Fa. CEAG, cable length 20 m	CB22146-001
Connection cable Profibus X3, X4	1	Mud-resistant cable with plug exlink, Fa. CEAG, cable length 20 m With integrated terminal resistor - this cable can only be used to connect the last valve in the fieldbus chain	CB22147-001
Connection cable Ethercat X3, X4	2	Mud-resistant cable with plug exlink, Fa. CEAG, cable length 20 m	CB22153-001
Connection cable X5, X6, X7	3	Mud-resistant cable with plug exlink, Fa. CEAG, cable length 20 m	CB22149-001
Connection cable pilot valve	1	Available optionally a pluggable cable with plug exlink, Fa. CEAG instead of the fixed cabling This option must be specified when the valve is ordered	CB22861-001
Available documents			
User manual D67xK series, German	1		CDS29588-de
User manual D67xK series, English	1		CDS29588-en
Supplemental documents			
Manual: Moog Valve and Pump Configuration Software, German	1		on request
Manual: Moog Valve and Pump Configuration Software, English	1		on request
TN 494	1	Permissible lengths for electrical connection lines from valves with integrated electronics	CA48851
TN 353	1	Potential equalization and protective grounding for hydraulic valves with integrated electronics	CA58437
TN 502	1	Valves with EtherCAT interface	CA566678
User manual for Digital Interface Valves with EtherCAT Interface	1	Valves with EtherCAT interface	CDS33722-en
Firmware B9926-DV013-B-211			
 Documents can be found and downloaded by specifying the item number: German-language documents a http://www.moog.de/german/about-moog-inc/industrial-group-literature-library/ English-language documents at http://www.moog.com/industrial/literature			

Tab. 41: Accessories and tools for all proportional valves in the D67XK series (part 2 of 2)

12.2 Tools for valves in the D67XK series

Item designation	Comments	Item number
Tools for the mating connectors of the connectors	Crimping tool for mating connector	see operating instructions eX-Link, CEAG



Tab. 42: Spare parts for valves in the D67XK series

12.3 NG-dependent accessories and spare parts

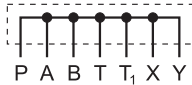

The accessories are Not included in scope of delivery
 ⇒ Chap. "5.2 Scope of delivery of the valve", page 54

12.3.1 Proportional valves in the D671K series

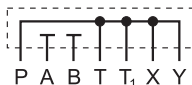
Item designation	Number required	Comments	Item number
Flushing plates			
for ports P, A, B, T, T ₁ , X, Y	1		B67728001
for ports P, T, T ₁ and X, Y	1		B67728-002
for ports P, T, T ₁ , X, Y	1		B67728-003
Connecting plates			
Service sealing set lower level		NBR 85 Shore FKM 85 Shore	B97215-N681-10 B97215-V681-10
Contains following O-rings:			
for ports A, B, P, T ₁ and X	6	ID 12.4 x dia. 1.8 [mm] (0.49 x 0.07 in)	NBR 85 Shore FKM 85 Shore
for port Y	1	ID 15.6 x dia. 1.8 [mm] (0.61 x 0.07 in)	NBR 85 Shore FKM 85 Shore
Service sealing set pilot valve or fail-safe valve		Set Set	NBR 85 Shore FKM 85 Shore
			B97215-N630F63 B97215-V630F63
Attachment screws		M6x40 EN ISO 4762 10.9 Tightening torque: 11 Nm (8 lbf ft) ± 10 %	A03665--060--040

Tab. 43: Spare parts and accessories in the D671K series with direct-operated pilot valve D633K

12.3.2 Proportional valves in the D672K series

Item designation	Number required	Comments	Item number
Flushing plate			-76741
Connecting plate			B97138-001
Attachment screws			
attachment screws	4	M10x60 EN ISO 4762 10.9 Tightening torque: 54 Nm (40 lbf ft) ± 10 %	A03665-100-060
attachment screws	2	M6x55 EN ISO 4762 10.9 Tightening torque: 11 Nm (8 lbf ft) ± 10 %	A03665-060-055
Service sealing set lower level			
Contains following O-rings:			
for ports A, B, P and T	4	ID 21.89 x dia. 2.6 [mm] (0.86 x 0.07 in) NBR 85 Shore FKM 85 Shore	B97215-N6X2-16 B97215-V6X2-16 -45122-129 -42082-129
for ports X and Y	2	ID 10.82 x dia. 1.8 [mm] (0.43 x 0.07 in) NBR 85 Shore FKM 85 Shore	-45122-022 -42082-022
Service sealing set pilot valve or fail-safe valve	1	Set	B97215-N630F63
	1	Set	B97215-V630F63

Tab. 44: Spare parts and accessories in the D672K series with direct-operated pilot valve D633K

12.3.3 Proportional valves in the D673K and D674K series

Item designation	Number required	Comments	Item number
Flushing plate			-76047-001
Connecting plate			A25855-009
attachment screws	6	M12x75 EN ISO 4762 10.9 Tightening torque: 94 Nm (69 lbf ft) ± 10 %	A03665-120-075
Service sealing set lower stage			
Contains following O-rings:			
for ports A, B, P and T	4	ID 34.60 x dia. 2.6 [mm] (1.36 x 0.10 in) NBR 85 Shore FKM 85 Shore	B97215-N6X4-25 B97215-V6X4-25 -45122-113 -42082-113
for ports X and Y	2	ID 20.92 x dia. 2.6 [mm] (0.82 x 0.10 in) NBR 85 Shore FKM 85 Shore	-45122-195 -42082-195
Service sealing set pilot valve or fail-safe valve	1	Set	B97215-N630F63
	1	Set	B97215-V630F63

Tab. 45: Spare parts and accessories in the D673K and D674K series with direct-operated pilot valve D633K

12.3.4 Proportional valves in the D675K series

Item designation	Number required	Comments	Item number
Flushing plate			not available
Connecting plate			A25855-001
attachment screws	6	M20x90 EN ISO 4762 10.9 Tightening torque: 460 Nm (339 lbf ft) ± 10 %	A03665-200-090
Service sealing set lower stage			HNBR 85 Shore FKM 85 Shore
Contains following O-rings:			B97215-S6X5-32 B97215-K6X5-32
for ports A, B, P and T	4	ID 53.60 x dia. 3.5 [mm] (2.11 x 0.14 in)	HNBR 85 Shore FKM 85 Shore
for ports X and Y	2	ID 14.00 x dia. 1.8 [mm] (0.55 x 0.07 in)	HNBR 85 Shore FKM 85 Shore
Service sealing set pilot valve or fail-safe valve	1 1	Set Set	NBR 85 Shore FKM 85 Shore
			B97215-N630F63 B97215-V630F63
Service sealing set fail-safe adapter plate	1 1	Set Set	NBR 85 Shore FKM 85 Shore
			B97215-N681-10 B97215-V681-10

Tab. 46: Spare parts and accessories in the D675K series with direct-operated pilot valve D633K

13 Ordering Information

Model no. (specified by the factory)

D671 - D675 X -

Type designation

1	2	3	4	5	6
•	•	•	•	•	•

Specification status

K Explosion-proof model

Model variant

Variant

1	Spool model	Series
P	Standard spool	D671K to D674K
B	Standard spool (5-way)	D671K (with P ₁ connection)
K	Stub shaft spool	D675K

2 Rated flow

(at $\Delta p = 5$ bar per control edge)		Series
30	30	D671K
60	60	D671K
80	80	D671K
01	150	D672K
02	250	D672K
03	350	D673K
05	550	D674K
10	1000	D675K
15	1500	D675K

3 Maximum operating pressure

With internal control connection X, the max. operating pressure corresponds to the max. pilot pressure.
The valve electronics are adapted to the control pressure.

B	70 bar
H	280 bar
K	350 bar

4 Spool model

A	4-way:	~ Zero overlap, linear characteristic curve
D	4-way:	10 % positive overlap, linear characteristic curve
R	4-way:	10 % positive overlap, broken characteristic curve
Q	5-way:	P → A, P ₁ → B, A → T, 5 % positive overlap, linear characteristic curve (only D671-B)
Y	4-way:	~ Zero overlap, kinked characteristic curve
Z	2x2-way:	A → T, B → T ₁ : (D671) P → B, T → A: only X and Y external (D672 to D675)

Others on request.

5 Pilot valve

S	Direct-operated pilot valve D633K, fixed cabling with ex-proof cable glands, not replaceable	D671K ... D675K
R	Direct-operated pilot valve D633K, replaceable cable with exlink plugs	D671K ... D675K

6 Fail-safe function

M	Middle position
F	P → B, A → T
D	P → A, B → T
K	Middle position
H	P → B, A → T

Others on request.

7	8	9	10	11	12	13	14	15	16
•	•	•	•	•	•	•	•	•	•
2 - • • • • • • • • • •									
16 Specified by the factory									
15 Specified by the factory									
14 Fieldbus connectors X3, X4									
G CAN									
H Profibus DP									
J EtherCAT									
O Without fieldbus interface									
13 Enable function									
A When the enable signal is deactivated the spool takes up a settable controlled neutral position.									
B When the enable signal is deactivated the spool takes up the defined end position A → T and B → T.									
K When the enable signal is deactivated the spool takes up a settable controlled neutral position.									
L When the enable signal is deactivated the spool takes up the defined end position A → T and B → T.									
Others on request.									
11 Electrical supply									
2 24 V DC									
10 Signals for 100% spool stroke									
Input signal Measurement output									
D ±10 V 2 to 10 V									
E 4 to 20 mA 4 to 20 mA									
M ±10 V 4 to 20 mA									
X ±10 mA 4 to 20 mA									
9 Field bus Field bus									
Y Others on request.									
9 Valve connector X1									
J 7-pole									
8 Sealing material Series									
H HNBR D671K to D674K									
V FKM D671K to D675K									
A T-ECOPUR (-40° C) D671K to D675K									
B FKM44 (-40° C) D671K to D675K									
S Edge seal HNBR D675K									
Others on request.									
7 Control type Limitations for the selection: see hydraulic symbols									
Intake X Outlet Y									
4 internal internal									
5 external internal									
6 external external									
7 internal external									

A B C D E F G H I J K L M N O P Q R S T U V W X Y Z

14 Keyword index

β_x : filter fineness

required filter fineness for filling filter for filling the hydraulic system • 132

Δp : pressure difference

pressure difference Δp • 50

Δp_N : rated pressure difference

rated pressure difference Δp_N • 50

2/2-way seat valve • 27

connector X9 in the block diagram of the valve/pump electronics • 66

A

A/D

A/D converter in the block diagram of the valve electronics • 20

Abbreviations

list of abbreviations • 247

A/D (analog-digital converter)

ACV (Axis Control Valve, valve with axis control functionality)

CAN (Controller Area Network)

CiA (CAN in Automation e. V.)

D/A (digital-analog converter)

DDV (Direct Drive Valve)

DIN (Deutsches Institut für Normung e. V.)

DSP (Draft Standard Proposal)

EMC (electromagnetic compatibility)

EN (European standard)

ESD (Electrostatic Discharge)

EU (European Union)

FKM (fluorocarbon rubber, material for gaskets, such as O-rings)

GND (Ground)

HNBR (Hydrogenated Nitrile Butadiene Rubber, material for gaskets, such as O-rings)

ID (Identifier)

ID (Inner Diameter, e.g. of O-rings)

IEC (International Electrotechnical Commission)

IP (International Protection)

ISM (industrial, scientific and medical, e.g. for ISM devices)

ISO (International Organization for Standardization)

LED (Light Emitting Diode)

LSS (Layer Setting Services)

LVDT (Linear Variable Differential Transformer)

NBR (Nitrile Butadiene Rubber, material for gaskets, such as O-rings)

NG (nominal size of the valve)

PC (Personal Computer)

PE (Protective Earth)

PELV (Protective Extra Low Voltage)

PID (Proportional Integral Differential, e. g. in PID controller)

PWM (Pulse Width Modulation)

SELV (Safety Extra Low Voltage)

SW (Width Across Flats for wrenches)

TN (Technical Note)

TÜV (Technischer Überwachungsverein)

USB (Universal Serial Bus)

UV (Ultraviolet)

VDE (Verband der Elektrotechnik Elektronik Informationstechnik e. V.)

VDI (Verein Deutscher Ingenieure e. V.)

Accessories, ordering information D67X • 222

acoustic emissions • 9

Acronyms • 247

Activation • 23, 39

ACV

transducer connectors X2, X5...X7

in the block diagram of the valve electronics • 20

Adapter for service connector X10 • 130

Air humidity, permissible relative air humidity for storage

D671 series • 166

D672 series • 177

D673 series • 188

D674 series • 199

D675 series • 210

Allocation of interfaces to connectors • 68

A B C D E F G H I J K L M N O P Q R S T U V W X Y Z

A B C D E F G H I J K L M N O P Q R S T U V W X Y Z

Ambient conditions

permissible ambient conditions

D671 series • 166

D672 series • 177

D673 series • 188

D674 series • 199

D675 series • 210

potentially explosive environment • 152

Ambient temperature, permissible ambient temperature

D671 series • 166

D672 series • 177

D673 series • 188

D674 series • 199

D675 series • 210

Armature of the linear force motor, in the representative depiction • 19**attachment screws**

Order information D671 • 225

Order information D672 • 226

Order information D673, D674 • 226

Order information D675 • 227

Attachment screws for the shipping plate • 59

Tightening torque (removal) • 145

width across flats • 58, 143

attachment screws for the shipping plate (removal) • 145**B****Block diagram of the valve/pump electronics** • 66**Block diagrams**

flow control (Q-control) • 33

valve electronics • 20

C**C_{typ}**

typical capacitance • 98

Cables

cable length in CAN networks • 109

cable length in Profibus-DP networks • 112

cable routing inside machines • 97

calculation

maximum length • 99

typical capacitance C_{typ} • 98typical resistance R_{typ} • 98

voltage drop per unit length • 99

dimensioning • 98

permissible lengths • 98–102

pin assignment of the cables for EtherCAT networks • 115

requirements • 94

suitable cables for

CAN networks • 109

EtherCAT networks • 115

Profibus-DP networks • 113

CAN

CAN bus interface • 48

CAN bus

general information • 77

pin assignment • 78

Technical data • 77

CAN (Controller Area Network)

literature, additional, CAN fundamentals • 250

CAN networks

cable cross section • 109

cable length • 109

interference immunity • 107

module address • 110

number of bus nodes • 110

suitable cables • 109

transmission rate • 110

Wiring • 106–110

Procedure • 106

wiring diagram • 107

Cavitation • 50**CE labeling of the M3000® modules** • A**Centering springs of the linear force motor**

in the representative depiction • 19

Characteristic curves

flow diagram

D671 series • 49

D672 series • 49

D673 series • 49

D674 series • 49

D675 series • 49

flow signal characteristic curve • 38

D671 series • 172

D672 series • 183, 194

D674 series • 205

D675 series • 216–217

hydraulic zero • 38

CiA

Quoted CiA standards • 163

Cleaning

disposal of auxiliary materials and substances used • 9

cleaning

cleaning connecting and mounting surfaces • 60

Cleanliness level of the hydraulic fluid • 133

D671 series • 166

D672 series • 177

D673 series • 188

D674 series • 199

D675 series • 210

Clock pulse output (signal of SSI transducer) • 76**Command signal U_{Command} of input voltage** • 103**Command signals for 100% spool stroke** in the type designation • 161**Command signals, single-ended** • 103**configuration of the valves** • 47

configuration via the fieldbus interface • 128

configuration via the service interface • 130

factory setting of the valves • 131

Configuration/start-up cable • 130

Ordering information D67X • 222

Connecting plates • 225, 227

Order information D672 • 226

Order information D673, D674 • 226

Connecting surface

cleaning • 60

troubleshooting in event of a leak • 147

Connection of the valve

connection to the hydraulic system • 56, 59–60

hydraulic connection • 56, 59–60

A B C D E F G H I J K L M N O P Q R S T U V W X Y Z

A B C D E F G H I J K L M N O P Q R S T U V W X Y Z

Connector

- Connector X1 • 23, 39
 - in the block diagram of the valve electronics • 20
 - in the connector overview • 67
- Fieldbus connectors X3 and X4 • 23–24
 - dust protection caps • 124
 - in the block diagram of the valve electronics • 20
- fieldbus connectors X3 and X4
 - in the connector overview • 67
- overview (arrangement of connectors on the valve electronics housing) • 67
- service connector X10 • 23–24
 - adapter • 130
 - dust protection cap • 124
 - in the block diagram of the valve electronics • 20
 - in the connector overview • 67
- transducer connectors X2, X5...X7
 - in the block diagram of the valve electronics • 20
- X1 (connector)
 - in the block diagram of the valve/pump electronics • 66
 - pin assignment • 69
- X2 (digital signal interface)
 - in the block diagram of the valve/pump electronics • 66
- X3 and X4 (fieldbus connectors)
 - in the block diagram of the valve/pump electronics • 66
- X5...X7 (analog input connectors)
 - in the block diagram of the valve/pump electronics • 66
- X8 (external LVDT connector)
 - in the block diagram of the valve/pump electronics • 66
- X9 (2/2-way seat valve connector)
 - in the block diagram of the valve/pump electronics • 66
- X10 (service connector)
 - in the block diagram of the valve/pump electronics • 66
- X11 (pilot valve connector)
 - in the block diagram of the valve/pump electronics • 66
- Connector X1 • 69**
- Connector overview**, arrangement of connectors on the valve electronics housing • 67
- Connector X1 • 23, 39**
 - in the block diagram of the valve electronics • 20
 - in the connector overview • 67
- Connector X10**
 - in the block diagram of the valve/pump electronics • 66
 - pin assignment • 86
- Connector X11 • 86**
 - in the block diagram of the valve/pump electronics • 66
 - pin assignment • 86
- Control loops**
 - troubleshooting in event of instabilities
 - instability of the external control loop • 149
 - instability of the internal valve control loops • 149
- Control ports A and B**
 - diameter
 - D671 series • 165
 - D672 series • 176
 - D673 series • 187
 - D674 series • 198
 - D675 series • 209
 - position in the holes in the mounting surface
 - D671 series • 165
 - D672 series • 176
 - D673 series • 187
 - D674 series • 198
 - D675 series • 209

Control type hydraulic intake/drain in the type designation • 160

Conversion of actual value output signals I_{out} (4–20 mA) into 2–10 V • 104

copyright
for this manual • A

Current command signal $I_{Command}$ • 103

Cutaway drawings
Two-stage proportional valve • 18

Cutaway views
linear force motor • 19
Two-stage proportional valve • 18

D

D/A

D/A converter in the block diagram of the valve electronics • 20

Data matrix code

example • 163
on the nameplate • 154–155
structure of the data matrix code • 163

Date of manufacture on the nameplate • 154–155

diesel effect • 133

Digit • 158

dimensions

D671 series
With pilot valve D633 • 168, 170
D672 series
With pilot valve D633 • 179, 181
D673 series
With pilot valve D633 • 190, 192
D674 series
With pilot valve D633 • 201, 203
D675 series
With pilot valve D633 • 212, 214

Directives, overview of quoted directives • 253

disposal • 9

Documents, supplemental • 5

catalog • 5
technical notes (TNs) • 5

Documents, supplementing

ordering information • 223
Ordering information D67X • 222

dust protection caps

for fieldbus connectors X3 and X4 • 124
for service connector X10 • 124

Duty cycle

D671 series • 167
D672 series • 178
D673 series • 189
D674 series • 200
D675 series • 211

E

Electrical data

D671 series • 167
D672 series • 178
D673 series • 189
D674 series • 200
D675 series • 211

A B C D E F G H I J K L M N O P Q R S T U V W X Y Z

A B C D E F G H I J K L M N O P Q R S T U V W X Y Z

Electrical shielding • 90–97**electrical shielding** • 94

- connecting the shield • 95
- connection with cable leadthrough • 95
- connection with plug connection • 96
- insulated shielding • 97
- requirement of cable routing • 97
- requirement of lines • 94

Embrittlement of gaskets • 146**embrittlement of gaskets** • 55**EMC**

- EMC protection requirements for immunity to interference and emitted interference
 - D671 series • 167
 - D672 series • 178
 - D673 series • 189
 - D674 series • 200
 - D675 series • 211
 - Technical data • 163
- EMC standards • 163
 - D671 series • 167
 - D672 series • 178
 - D673 series • 189
 - D674 series • 200
 - D675 series • 211
- requirements during start-up • 120

EMC (Electromagnetic compatibility)

- EMC Directive • 253

Emitted interference

- D671 series • 167
- D672 series • 178
- D673 series • 189
- D674 series • 200
- D675 series • 211
- Technical data • 163

Environmental protection

- acoustic emissions • 9
- disposal • 9

equipotential bonding

- deficient equipotential bonding • 94
- electrical shielding • 94
- ground loops • 93
- insulated shielding in the event of deficient equipotential bonding • 97
- maximum potential difference (7 V) • 92
- of machines • 91
- performance • 92
- protective conductor • 92
 - cross section • 92

Equipotential bonding system, electromagnetic compatibility (EMC) • 163**ESD** • 16**EtherCAT**

- general information • 80
- literature, additional, EtherCAT fundamentals • 250
- maximum number of bus nodes • 81
- module address • 116
 - auto-increment addressing • 116
 - fixed node addressing • 116
- pin assignment of the cables for EtherCAT networks • 115
- pin assignment, connector X3 • 82
- suitable cables for EtherCAT networks • 115
- Technical data • 81
- transmission rate • 116
- wiring diagram, EtherCAT networks • 115
- wiring EtherCAT networks • 114–116
 - Procedure • 114

EU (European Union)**Evenness**, required for mounting surface • 57**Exclusion of liability** • 11**Exclusion of warranty** • 11**External LVDT connector X8**

- in the block diagram of the valve/pump electronics • 66

F**f_i**

- limit frequency • 101

factory setting of the valves • 131**Fail-safe events** • 28

- control commands • 30
- drop in the pilot pressure p_x • 29
- failure of the supply voltage • 29
- restarting the valve after the occurrence of a fail-safe event • 31
 - settable fault reaction • 30
 - signals at the enable input • 29

Fail-safe functions • 25

- electrical fail-safe function • 28
- hydraulic symbols • 35–36
- mechanical fail-safe functions • 26
- Valves with mechanical fail-safe function M • 26
- valves with mechanical fail-safe function M
 - hydraulic symbols • 35
- Valves with mechanical fail-safe function F and D • 26
- valves with mechanical fail-safe function F and D
 - hydraulic symbols • 36

Fail-safe states

- electrical fail-safe state • 25, 28
- mechanical fail-safe state • 25, 27
- Mechanical fail-safe state in the type designation • 159

fail-safe valves • 27

- 2/2-way seat valve • 27
- hydraulic symbol • 35

Fail-safe variant, in the type designation • 159**Fieldbus**

- connection of the valve/pump
 - Safety instructions • 62

Fieldbus connectors X3 and X4 • 23–24

- dust protection caps • 124
- in the block diagram of the valve electronics • 20

fieldbus connectors X3 and X4

- in the connector overview • 67

Fieldbus connectors X3 and X4 in the type designation • 162

A B C D E F G H I J K L M N O P Q R S T U V W X Y Z

A B C D E F G H I J K L M N O P Q R S T U V W X Y Z

Fieldbus connectors X3 and X4

- CAN bus connectors • 78
- EtherCAT connectors • 82
- general information • 77
- in the block diagram of the valve/pump electronics • 66
- Profibus-DP connectors • 80
- versions of the connectors • 77

Fieldbus interface • 22

- configuration of the valves via the fieldbus interface • 128
- in the block diagram of the valve electronics • 20

filling filter for filling the hydraulic system

- required filter fineness β_x • 132

Filling the hydraulic system • 132

filter element

- in the representative depiction of the valve • 18

Filter fineness β_x

- filling filter for filling the hydraulic system • 132

Filter, filling filter for filling the hydraulic system

- required filter fineness • 132

FKM

- D671 series • 225
- D672 series • 226
- D673, D674 series • 226
- D675 series • 227

Flow control (Q-control)

- troubleshooting in event of instability of the internal valve control loop • 149

flow control (Q-control) • 33

- block diagram • 33

flow diagram

- D671 series • 49
- D672 series • 49
- D673 series • 49
- D674 series • 49
- D675 series • 49

flow signal characteristic curve • 38

- D671 series • 172
- D672 series • 183, 194
- D674 series • 205
- D675 series • 217
- hydraulic zero • 38

Flow speed • 50

Flow Q

- flow signal characteristic curve • 38

- D671 series • 172
- D672 series • 183
- D673 series • 194
- D674 series • 205
- D675 series • 216–217

- formula for calculation • 50

leakage flow Q_L

- D671 series • 166
- D672 series • 177
- D673 series • 188
- D674 series • 199
- D675 series • 210

maximum flow Q_{max}

- D671 series • 49, 166
- D672 series • 49, 177
- D673 series • 49, 188
- D674 series • 49, 199
- D675 series • 49, 210

rated flow Q_N

- D671 series • 166
- D672 series • 177
- D673 series • 188
- D674 series • 199
- D675 series • 210
- Nameplate • 157

Flushing plate

- Order information D671 • 225
- Order information D672 • 226
- Order information D673, D674 • 226
- Order information D675 • 227
- using when flushing the hydraulic system • 132

Formula for calculating the flow Q • 50

Formulae

- approximation formula for calculating the pilot pressure p_x • 17
- formula for calculating the flow Q • 50

function

- linear force motor • 19
- Valves of the D67X series • 17

Fuse

- D671 series • 167
- D672 series • 178
- D673 series • 189
- D674 series • 200
- D675 series • 211

Fuse protection, external fuse protection for each valve

- D671 series • 167
- D672 series • 178
- D673 series • 189
- D674 series • 200
- D675 series • 211

A B C D E F G H I J K L M N O P Q R S T U V W X Y Z

A B C D E F G H I J K L M N O P Q R S T U V W X Y Z

G

Gaskets

- checking and replacing the O-rings
 - ports • 146
- cleaning • 60
- embrittlement • 55, 146
- Order information D671 • 225
- Order information D672 • 226
- Order information D673, D674 • 226
- Order information D675 • 227
- Service sealing set, ordering information D671 • 225
- Service sealing set, ordering information D672 • 226
- Service sealing set, ordering information D673, D674 • 226
- Service sealing set, ordering information D675 • 227

GND

- ground contact of connector X1 • 69

Ground connection of connector X1 • 69

Ground contact (GND) of connector X1 • 69

Ground (electrical)

- Ground contact (GND) of connector X1 • 69
- single-ended command signals • 103
- single-ended connection of the analog command inputs • 103

Ground (in kg)

- D671 series • 166
- D672 series • 177
- D673 series • 188
- D674 series • 199
- D675 series • 210

Gumming of hydraulic fluid during long-term storage • 55

H

handling in accordance with safety requirements • 14, 61

Handling, in accordance with safety requirements • 14, 61

Hydraulic data

- D671 series • 166
- D672 series • 177
- D673 series • 188
- D674 series • 199
- D675 series • 210

Hydraulic fluid

- disposal • 9

hydraulic fluid

- cleanliness level • 133
 - D671 series • 166
 - D672 series • 177
 - D673 series • 188
 - D674 series • 199
 - D675 series • 210
- diesel effect • 133
- gumming during long-term storage • 55
- permissible fluids
 - D671 series • 166
 - D672 series • 177
 - D673 series • 188
 - D674 series • 199
 - D675 series • 210
- permissible temperature range
 - D671 series • 166
 - D672 series • 177
 - D673 series • 188
 - D674 series • 199
 - D675 series • 210
- permissible viscosity ν
 - D671 series • 166
 - D672 series • 177
 - D673 series • 188
 - D674 series • 199
 - D675 series • 210
- required filter fineness β_x for filling filter for filling the hydraulic system • 132

Hydraulic symbols • 34–36

- on the nameplate • 154–155

hydraulic symbols • 35

- 2-way operation • 34
- 2x2-way operation • 34
- 3-way operation • 36
- 4-way operation • 35
- fail-safe function D • 36
- fail-safe function F • 36
- fail-safe functions M and W • 35
- fail-safe valves • 35

Hydraulic system

- connection of the valve to the hydraulic system • 56, 59
- filling and flushing • 132
 - minimum flushing time • 133
 - required filter fineness for filling filter • 132
- preparing • 132
- Start-up • 133
- start-up • 132–133
- venting • 133

Hysteresis

- D671 series • 167
- D672 series • 178
- D673 series • 189
- D674 series • 200
- D675 series • 211

I

- I_{Command}
 - current command signal • 103
- I_{out}
 - output current • 104

A B C D E F G H I J K L M N O P Q R S T U V W X Y Z

A B C D E F G H I J K L M N O P Q R S T U V W X Y Z

I_{Supply}

supply current • 103

ID (Identifier)**ID** (Inner Diameter, e.g. of O-rings)**IEC** (International Electrotechnical Commission)**Immunity to interference**

D671 series • 167

D672 series • 178

D673 series • 189

D674 series • 200

D675 series • 211

Technical data • 163

incremental transducer

power supply • 75

reversal point of signals • 105

speed variation of signals • 105

Index of figures • x**Index of Tables • viii****Initial start-up, safety instructions • 61****Input resistances at connectors X5...X7 • 85****Input voltage U_{in} • 103****Inputs, analog command inputs**

±10 mA floating • 42

±10 V floating • 42

4–20 mA floating • 44

current inputs

±10 mA floating • 42

4–20 mA floating • 44

flow control command inputs

±10 mA floating • 42

±10 V floating • 42

4–20 mA floating • 44

in the block diagram of the valve electronics • 20

signal type on the nameplate • 154–155

voltage inputs

±10 V floating • 42

Inputs, analog inputs

at connectors X5...X7

±10 V • 84

0–10 mA • 84

0–10 V • 84

4–20 mA • 85

benefits of the different signal types • 89

Connections • 74

in the block diagram of the valve/pump electronics • 66

maximum current for transducer supply • 117

on connector X1 • 69

±10 mA • 72

±10 V • 71

0–10 mA • 72

0–10 V • 71

4–20 mA • 73

overview of connections • 70

pin assignment X5...X7 • 83

power supply to the transducer • 83

signal types

at connectors X5...X7 • 84

evaluating the signal types • 89

on connector X1 • 71

single-ended connection • 103

Wiring • 117–119

2-wire transducer • 118

3-wire transducer • 118

4-wire transducer • 118

Connectors X5...X7 • 117–119

Inputs, command value input

signal type identification in the type designation • 41

Inputs, digital inputs

enable input • 23, 29, 46, 69

in the block diagram of the valve electronics • 20

in the block diagram of the valve/pump electronics • 66

signals at the enable input as fail-safe events • 29

on connector X1

enable input • 74

overview of connections • 74

Instability of the control loops, troubleshooting

instability of the internal valve control loops • 149

instability of the external control loop • 149**installation drawing**

D671 series

With pilot valve D633 • 168, 170

D672 series

With pilot valve D633 • 179, 181

D673 series

With pilot valve D633 • 190, 192

D674 series

With pilot valve D633 • 201, 203

D675 series

With pilot valve D633 • 212, 214

Installation position

D671 series • 166

D672 series • 177

D673 series • 188

D674 series • 199

D675 series • 210

Installation screws

required quality class • 58

specification • 58

tightening torque • 58

width across flats • 58, 143

Intended operation • 5**IP**

protection type

D671 series • 167

D672 series • 178

D673 series • 189

D674 series • 200

D675 series • 211

Item numbers

accessories • 222

L**I_{max}**

maximum length of the supply cable • 99

Leak, troubleshooting

Connection surface of the valves • 147

linear force motor screw plug • 148

leakage flow Q_L

D671 series • 166

D672 series • 177

D673 series • 188

D674 series • 199

D675 series • 210

A B C D E F G H I J K L M N O P Q R S T U V W X Y Z

A B C D E F G H I J K L M N O P Q R S T U V W X Y Z

Leakage port Y • 37

- diameter
 - D671 series • 165
 - D672 series • 176
 - D673 series • 187
 - D674 series • 198
 - D675 series • 209
- position in the holes in the mounting surface
 - D671 series • 165
 - D672 series • 176
 - D673 series • 187
 - D674 series • 198
 - D675 series • 209

LED

- Status LEDs
 - in the block diagram of the valve/pump electronics • 66
- status LEDs
 - in the block diagram of the valve electronics • 20
 - indication of operating state and network status • 138

Linear force motor

- screw plug
 - troubleshooting in event of a leak • 148

linear force motor • 19

- Armature • 19
- Bearing • 19
- Centering springs • 19
- Coil • 19
- Cross section • 19
- Permanent magnets • 19
- representative depiction • 19
- screw plug • 19

Literature, additional

- CAN fundamentals • 250
- directives, quoted • 253
- EtherCAT fundamentals • 250
- Fundamentals of hydraulics • 249
- Moog publications • 250
- Profibus fundamentals • 250
- standards, quoted • 250–253
- supplemental documents • 5

Load impedance R_L

- analog actual value outputs • 104

LSS

- LSS address
 - example • 163
 - on the nameplate • 154–155
 - structure of the LSS address • 163

LVDT (position transducer)

- in the block diagram of the valve electronics • 20
- in the block diagram of the valve/pump electronics • 66

M**Machine controller, configuration of the valves • 128****Maintenance**

- O-ring checking and replacement
 - ports • 146

Maintenance (service) • 140**Manufacturer's declaration • 12****Microprocessor control**

- for storing the valve software parameters • 131
- in the valve electronics • 20

microprocessor system

- in the block diagram of the valve electronics • 20

Minimum flushing time for flushing the hydraulic system • 133**Mode of operation**

- linear force motor • 19
- Valves of the D67X series • 17

Model number

- on the nameplate • 154–155
- structure of the model number • 156

Model number and type designation • 156**Moog Valve and Pump Configuration Software • 48**

- operation • 122
- ordering information D67X • 222
- possible faults • 122
- safety instructions • 65, 121–122

Moog Valve and Pump Configuration Software, configuration • 128**mounting • 56, 59**

- Installation position
 - D671 series • 166
 - D672 series • 177
 - D673 series • 188
 - D674 series • 199
 - D675 series • 210
- mounting option
 - D671 series • 166
 - D672 series • 177
 - D673 series • 188
 - D674 series • 199
 - D675 series • 210
- Procedure • 60
- tools and materials required • 58

mounting option

- D671 series • 166
- D672 series • 177
- D673 series • 188
- D674 series • 199
- D675 series • 210

Mounting surface • 57

- cleaning • 60
- permissible average roughness R_a • 57
- required evenness • 57

N**v:viscosity**

- permissible viscosity v of the hydraulic fluid
 - D671 series • 166
 - D672 series • 177
 - D673 series • 188
 - D674 series • 199
 - D675 series • 210

Nameplate • 154–155**NBR**

- D671 series • 225
- D672 series • 226
- D673, D674 series • 226
- D675 series • 227

A B C D E F G H I J K L M N O P Q R S T U V W X Y Z

A B C D E F G H I J K L M N O P Q R S T U V W X Y Z

NG

- Technical Data
 - D671 series • 166
 - D672 series • 177
 - D673 series • 188
 - D674 series • 199
 - D675 series • 210

Nominal size

- D671 series • 166
- D672 series • 177
- D673 series • 188
- D674 series • 199
- D675 series • 210

Notes on user manual • 1**O****occupational safety and health**

- safe distances for cardiac pacemakers and similar devices due to magnetic fields • 15
- sound insulation measures • 15

Operating pressure in the type designation • 157**operating pressure p_P**

- maximum operating pressure
 - D671 series • 166
 - D672 series • 177
 - D673 series • 188
 - D674 series • 199
 - D675 series • 210

Maximum operating pressure on the nameplate • 154–155

Operation of the valves • 134–138

- ambient conditions, permissible
 - D671 series • 166
 - D672 series • 177
 - D673 series • 188
 - D674 series • 199
 - D675 series • 210

- intended operation • 5
- necessary preparations • 137

Order numbers

- accessories • 222

Ordering information D67X

- accessories • 222

O-rings

- checking and replacing the O-rings
 - ports • 146
- cleaning • 60
- embrittlement • 55, 146
- Order information D671 • 225
- Order information D673, D674 • 226
- Order information D675 • 227
- ordering information • 226
- Service sealing set, ordering information D671 • 225
- Service sealing set, ordering information D672 • 226
- Service sealing set, ordering information D673, D674 • 226
- Service sealing set, ordering information D675 • 227

Output current I_{out} • 104**Output voltage U_{out} • 104****Output, analog**

- spool position actual value output 4–20 mA • 46

Output, analog stroke position signal

- 4–20 mA (actual value output) • 46

Outputs, analog actual value output

- in the block diagram of the valve electronics • 20

Outputs, analog actual value outputs

- conversion of I_{out} (4–20 mA) into 2–10 V • 104

Outputs, analog outputs

- Connections • 74
 - in the block diagram of the valve/pump electronics • 66
 - on connector X1 • 69
 - 2–10 V • 73
 - 4–20 mA • 73

- overview of connections • 70

Outputs, digital outputs

- on connector X1
 - Valve standby • 74
- overview of connections • 74

Outputs, spool position signal

- signal type identification in the type designation • 41

overlap • 35, 38

- zero overlap • 35, 38

P**Packaging**

- disposal • 9
- storing original packaging • 53

Part numbers

- accessories • 222

PC (Personal Computer)**PE**

- protective conductor contact of connector X1 • 69

PELV power pack

- Ordering information D67X • 222

Permanent magnets of the linear force motor

- in the representative depiction • 19

Pilot flow

- D671 series • 166
- D672 series • 177
- D673 series • 188
- D674 series • 199
- D675 series • 210

Pilot identification in the type designation • 37**Pilot identification in the type designation • 37****Pilot pressure port X • 37**

- diameter
 - D671 series • 165
 - D672 series • 176
 - D673 series • 187
 - D674 series • 198
 - D675 series • 209

- position in the holes in the mounting surface

- D671 series • 165
- D672 series • 176
- D673 series • 187
- D674 series • 198
- D675 series • 209

A B C D E F G H I J K L M N O P Q R S T U V W X Y Z

A B C D E F G H I J K L M N O P Q R S T U V W X Y Z

pilot pressure p_x

- approximation formula for calculation • 17
- D671 series • 166
- D672 series • 177
- D673 series • 188
- D674 series • 199
- D675 series • 210
- drop in the pilot pressure as fail-safe event • 29
 - restarting afterwards • 31
- on the nameplate • 154–155

Pilot valve connector X11

- in the block diagram of the valve/pump electronics • 66
- pin assignment • 86

Pilot valve D633

- in the representative depiction of the valve • 18
- Technical Data D671 • 166
- Technical Data D672 • 177
- Technical Data D675 • 210

Pilot valve in the type designation • 158**pin assignment**

- X1 (connector)
 - 6+PE-pin • 69
- X2 (digital signal interface)
 - SSI transducer • 76
- X3 and X4 (fieldbus interface)
 - CAN bus • 78
 - EtherCAT • 82
 - Profibus-DP • 80
- X5...X7 (analog input connectors) • 83
- X10 (service connector) • 86
- X11 (pilot valve connector) • 86

Ports

- Diameter of ports
 - D671 series • 166
 - D672 series • 177
 - D673 series • 188
 - D674 series • 199
 - D675 series • 210
- on the nameplate • 154–155

ports

- O-ring checking and replacement • 146
- troubleshooting in event of leaks • 147

Position transducer (LVDT)

- in the block diagram of the valve electronics • 20
- in the block diagram of the valve/pump electronics • 66

Potentially explosive environment • 152**Power supply**

- failure of the supply voltage • 29
 - restarting the valve afterwards • 31
- Supply voltage
 - failure of the supply voltage • 29
 - in the block diagram of the valve electronics • 20

power supply

- connection via connector X1 • 69
- PELV power pack
 - Ordering information D67X • 222
- Power supply
 - D671 series • 167
 - D672 series • 178
 - D673 series • 189
 - D674 series • 200
 - D675 series • 211
 - on the nameplate • 154–155
- Power supply cord, order information D67X • 222
- requirements of supply voltage • 70
- SELV power pack
 - D671 series • 167
 - D672 series • 178
 - D673 series • 189
 - D674 series • 200
 - D675 series • 211

Power supply cord, order information D67X • 222**Pressure difference Δp • 50****pressure limitation • 16–17, 125****Pressure port P**

- diameter
 - D671 series • 165
 - D672 series • 176
 - D673 series • 187
 - D674 series • 198
 - D675 series • 209
- position in the holes in the mounting surface
 - D671 series • 165
 - D672 series • 176
 - D673 series • 187
 - D674 series • 198
 - D675 series • 209

Pressure transducer, internal

- in the block diagram of the valve electronics • 20

Pressure p

- operating pressure p_p
 - maximum operating pressure
 - D671 series • 166
 - D672 series • 177
 - D673 series • 188
 - D674 series • 199
 - D675 series • 210
 - Maximum operating pressure on the nameplate • 154–155

pilot pressure p_x

- approximation formula for calculation • 17
- D671 series • 166
- D672 series • 177
- D673 series • 188
- D674 series • 199
- D675 series • 210
- drop in the pilot pressure • 29
 - restarting afterwards • 31
- on the nameplate • 154–155

Procedure for electrically connecting valves/pumps • 89**Profibus**

- literature, additional, Profibus fundamentals • 250

Profibus-DP

- maximum number of bus nodes • 79
- pin assignment • 80
- Technical data • 79

A B C D E F G H I J K L M N O P Q R S T U V W X Y Z

A B C D E F G H I J K L M N O P Q R S T U V W X Y Z

Profibus-DP interface

general information • 78

Profibus-DP networks

cable cross section • 112

cable length • 112

module address • 113

suitable cables • 113

transmission rate • 113

Wiring • 111–113

Procedure • 111

wiring diagram • 112

Prohibition to duplicate - user manual • A

Prohibition to reproduce - user manual • A

protection type

D671 series • 167

D672 series • 178

D673 series • 189

D674 series • 200

D675 series • 211

protective conductor

deficient equipotential bonding • 94

ground loops • 93

maximum potential difference (7 V) • 92

procedure for connecting • 92

required cross section • 92

Protective conductor contact PE of connector X1 • 69

Protective grounding • 90–97

of connector X1 • 69

of machines • 91

performance • 92

Protective grounding, electromagnetic compatibility

(EMC) • 163

Pulse width modulation (PWM)

in the block diagram of the valve electronics • 20

PWM (Pulse Width Modulation)

in the block diagram of the valve electronics • 20

Q**Q_{max}**

maximum flow D671 • 166

maximum flow D672 • 177

maximum flow D673 • 188

maximum flow D674 • 199

maximum flow D675 • 210

Q_L

leakage flow

D671 series • 166

D672 series • 177

D673 series • 188

D674 series • 199

D675 series • 210

Q_N

Rated flow

D671 series • 166

D672 series • 177

D673 series • 188

D674 series • 199

D675 series • 210

Rated flow, type designation • 157

q_{typ}

typical cross section • 98

Qualification, requirements of the user • 7

Quality class, required for installation screws • 58

R**ρ_{Cu}**

resistivity of copper • 98

R_L

load impedance R_L of the analog actual value outputs • 104

R_{typ}

typical resistance • 98

R_a

average permissible roughness R_a for mounting surface • 57

Rated flow in the type designation • 157

Rated flow Q_N

D671 series • 166

D672 series • 177

D673 series • 188

D674 series • 199

D675 series • 210

Nameplate • 157

Rated pressure difference Δp_N • 50

reference temperature of the valve electronics

D671 series • 166

D672 series • 177

D673 series • 188

D674 series • 199

D675 series • 210

Release date of the user manual • 2

Removal of the valves (service), procedure • 145

Removal (service) • 140

Removing • 145

Removing of the valves • 143

Repair (service) • 140, 150

Representative depictions

linear force motor • 19

Two-stage proportional valve with pilot valve D633 • 18

Responsibilities • 10

Responsibility of the manufacturer and the operator of the machine • 10

restarting the valve • 31

Roughness R_a, average, permissible for mounting surface • 57

S

Safe distances for cardiac pacemakers and similar devices due to magnetic fields • 15

A B C D E F G H I J K L M N O P Q R S T U V W X Y Z

A B C D E F G H I J K L M N O P Q R S T U V W X Y Z

Safety instructions

- general safety instructions • 16
- analog command inputs • 42, 44
- attachment elements for the shipping plate • 59
- attachment elements for the shipping plate (removal) • 145
- cleaning the valve connecting surface, mounting surface and O-rings • 60
- configuration of the valves • 128
- connection to the hydraulic system • 56, 59
- delivery of repaired valves and replacement valves with factory settings • 150
- Design of the valve with respect to flow • 32
- diesel effect • 133
- disposal • 9
- electrical and hydraulic zero positions • 38
- electrical properties • 62
- equipotential bonding • 63
- ESD • 16
- failure of the supply voltage • 29
- flushing the hydraulic system • 132
- handling in accordance with safety requirements • 14, 61
- Holes in mounting surface
 - D671 series • 165
- Holes in the mounting surface
 - D672 series • 176
 - D673 series • 187
 - D674 series • 198
 - D675 series • 209
- hydraulic connection • 56, 59
- Hydraulic fluid • 16, 56
- hydraulic fluid • 123
 - diesel effect • 133
- initial start-up • 61
 - connection to fieldbus • 62
- installation •
 - 14–15, 22, 62–63, 65–66, 90, 106, 110–111, 113–114, 116, 121–122, 142, 222
- Intended operation • 5
- isolation from the mains system • 62
- Leak on the linear motor screw plug (service) • 148
- Linear force motor screw plug (service) • 148
- maintenance •
 - 14–15, 22, 62–63, 65–66, 90, 106, 110–111, 113–114, 116, 121–122, 142, 222
- Maintenance (service) • 140
- Moog Valve and Pump Configuration Software •
 - 65, 121–122
- mounting • 56, 59
- occupational safety and health • 15
 - safe distances for cardiac pacemakers and similar devices due to magnetic fields • 15
 - sound insulation measures • 15
- open connectors • 124
- operation • 134
- power pack • 62
- pressure limitation • 16–17, 125
- protective conductor system • 63
- Removal (service) • 140, 145
- repair •
 - 14–15, 22, 62–63, 65–66, 90, 106, 110–111, 113–114, 116, 121–122, 142, 222
- Repair (service) • 140, 150
- restarting the valve after the valve has adopted the fail-safe state • 31
- safety-critical applications • 25
 - selection and qualification of personnel • 7
 - service • 140
 - Service (service) • 140, 150
 - Shipping plate (removal) • 145
 - shutting down the valve • 138
 - sound insulation measures • 9
 - start-up • 123–125
 - structural modifications • 8
 - Supply voltage
 - failure of the supply voltage • 29
 - symbols, used • 3
 - Technical Data • 16
 - Technical data • 152
 - Troubleshooting "No hydraulic response by the valves" • 148
 - Troubleshooting (service) • 140, 148
 - troubleshootingSafety instructions removing •
 - 14–15, 22, 62–63, 65–66, 90, 106, 110–111, 113–114, 116, 121–122, 142, 222
 - typographical conventions • 3
 - use, intended • 5
 - valve software • 47, 128
 - valve status 'NOT READY' • 21, 28, 30
 - zero positions, electrical and hydraulic • 38
- safety notes, operation**
 - configuration of the valves • 136
 - valve software • 136
- Safety notes, service**
 - Hydraulic fluid • 140
- Safety-critical applications** • 25
- Scope of delivery** • 54
- Screw plug on the linear force motor**
 - in the representative depiction • 19
 - troubleshooting in event of a leak • 148
- Seal material** in the type designation • 160
- selection and qualification of personnel** • 7
 - qualified users • 7
- SELV power pack**
 - D671 series • 167
 - D672 series • 178
 - D673 series • 189
 - D674 series • 200
 - D675 series • 211
- SensorSup**
 - supply voltage to the SSI transducer • 76
- Serial number** on the nameplate • 154–155
- service** • 140–151
- Service connector X10, configuration of the valves** • 130
- Service connector X10**
 - general information • 86
 - in the block diagram of the valve/pump electronics • 66
 - pin assignment • 86
- service connector X10** • 23–24
 - adapter • 130
 - dust protection cap • 124
 - in the block diagram of the valve electronics • 20
 - in the connector overview • 67
- Service interface** • 22
 - configuration of the valves via the service interface • 130
 - in the block diagram of the valve electronics • 20
- Service sealing set**, ordering information D671 • 225
- Service sealing set**, ordering information D672 • 226
- Service sealing set**, ordering information D673, D674 • 226
- Service sealing set**, ordering information D675 • 227

A B C D E F G H I J K L M N O P Q R S T U V W X Y Z

A B C D E F G H I J K L M N O P Q R S T U V W X Y Z

shipping plate • 52, 126

- Attachment screws • 59
 - Tightening torque (removal) • 145
 - width across flats • 58
- Attachment screws (removal) • 145
- mounting • 145
- removal • 60

Shock protection

- D671 series • 166
- D672 series • 177
- D673 series • 188
- D674 series • 199
- D675 series • 210

shutting down the valve • 138**Signal cables**

- cable length • 102
- calculation
 - limit frequency • 101
 - typical capacitance C_{typ} • 98
 - typical resistance R_{typ} • 98
- dimensioning • 98
- influence of capacitance per unit length • 101
- influence of resistance • 101
- limit frequency • 101
- permissible lengths • 98–102
- recommendations • 101

Signal interface, digital signal interface X2

- in the block diagram of the valve/pump electronics • 66
- SSI transducer • 76

Signal interfaces • 22–23**Signal type identification** in the type designation • 41**Signal types for analog command inputs**

- on the nameplate • 154–155

Signal zero of connector X1 • 69**Signal, differential signal**

- evaluation • 89

Software

- Moog Valve and Pump Configuration Software • 48
 - ordering information D67X • 222
- Moog Valve and Pump Configuration Software, configuration • 128
- valve software • 47
 - configuration of the valves • 47, 128
 - via the fieldbus interface • 128
 - via the service interface • 130
 - factory setting • 131
 - Microprocessor control • 20
 - for storing parameters • 131

sound insulation measures • 9, 15**Spool**

- defined spring-determined position of the spool in the mechanical fail-safe state • 27
- overlap • 35, 38
- Step response time for 0–100 % spool stroke
 - D671 series • 167
 - D672 series • 178
 - D673 series • 189
 - D674 series • 200
 - D675 series • 211
- zero overlap • 35, 38
- zero position (electrical and hydraulic) • 38

Spool position based on enable signal in the type designation • 162**Spool position controller**

- in the Q-control block diagram • 33

Spool type in the type designation • 156**Spool version** in the type designation • 158**SSI transducer**

- cable break monitoring • 75
- connection to valve/pump • 105
- pin assignment • 76
- power supply • 76
- recommended cable types • 75
- signals between valve/pump • 105
- supported transducer types • 75
- Wiring • 105
- wiring diagram • 105

Standards

- overview of quoted standards • 250–253
- CiA DSP • 248, 250
- DIN • 251
- DIN EN • 252
- DIN EN ISO • 253
- IEC • 251
- IEEE • 251
- ISO • 253
- ISO/DIS • 251
- ISO/IEC • 251
- overview of quoted standards • ??–251

Start-up

- EMC requirements • 120
- Hydraulic system • 133
- hydraulic system • 132–133
- restarting the valve • 31
- valve • 123–131

Static and dynamic data

- D671 series • 167
- D672 series • 178
- D673 series • 189
- D674 series • 200
- D675 series • 211

Step response time for 0–100 % spool stroke

- D671 series • 167
- D672 series • 178
- D673 series • 189
- D674 series • 200
- D675 series • 211

Storage

- storage location for user manual • 2
- user manual • 2

storage • 52, 55

- ambient conditions, permissible
 - D671 series • 166
 - D672 series • 177
 - D673 series • 188
 - D674 series • 199
 - D675 series • 210
- embrittlement of gaskets • 55
- gumming of hydraulic fluid • 55
- original packaging • 53

Structural modifications • 8**styles/spelling, used** • 3**Subject to change without notice - user manual** • A, 2**Supplementing documents** • 5

- catalog • 5
- technical notes (TNs) • 5

A B C D E F G H I J K L M N O P Q R S T U V W X Y Z

A B C D E F G H I J K L M N O P Q R S T U V W X Y Z

Supply cables

calculation

- maximum length • 99
- typical capacitance C_{typ} • 98
- typical resistance R_{typ} • 98
- voltage drop per unit length • 99

dimensioning • 98

permissible lengths • 98–102

Supply current I_{supply} • 103**supply voltage**

in the block diagram of the valve/pump electronics • 66

Supply voltage in the type designation • 161**Supply zero of connector X1 • 69****Symbols**

list of symbols • 247

 β_x (filter fineness) Δp (pressure difference) Δp_N (rated pressure difference) i_{comm} (current command signal) i_{in} (input current) i_{out} (output current) i_{supply} (supply current) l (length) ν (viscosity) P_{max} (power consumption at maximum flow) P_{min} (power consumption for motor in neutral position) p (pressure) p_N (rated pressure) p_P (operating pressure) p_X (pilot pressure) Q (flow) Q (flow rate of a pump) Q_L (leakage flow) Q_{max} (maximum flow) Q_N (rated flow) R_a (average roughness) R_{in} (input resistance) r_L (load impedance) T (Temperature) t (time) U_{cable} (voltage drop on the cable) u_{comm} (input voltage command signal) u_{in} (input voltage) u_{out} (output voltage) V (volume)**symbols, used • 3****T** t (symbol for time)**Table of contents • ii****Tank port T**

diameter

- D671 series • 165
- D672 series • 176
- D673 series • 187
- D674 series • 198
- D675 series • 209

position in the holes in the mounting surface

- D671 series • 165
- D672 series • 176
- D673 series • 187
- D674 series • 198
- D675 series • 209

Technical Data

D671 series

With pilot valve D633 • 166

D672 series

With pilot valve D633 • 177

D673 series

With pilot valve D633 • 188

D674 series

With pilot valve D633 • 199

D675 series

With pilot valve D633 • 210

General technical data D671 • 166

General technical data D672 • 177

General technical data D673 • 188

General technical data D674 • 199

General technical data D675 • 210

hydraulic data

D671 series • 166

D672 series • 177

D673 series • 188

D674 series • 199

D675 series • 210

Technical data

Overview • 152

Temperature T

permissible ambient temperature

D671 series • 166

D672 series • 177

D673 series • 188

D674 series • 199

D675 series • 210

permissible temperature range for hydraulic fluid

D671 series • 166

D672 series • 177

D673 series • 188

D674 series • 199

D675 series • 210

reference temperature of the valve electronics

D671 series • 166

D672 series • 177

D673 series • 188

D674 series • 199

D675 series • 210

Threshold

D671 series • 167

D672 series • 178

D673 series • 189

D674 series • 200

D675 series • 211

Throttle valve • 17

A B C D E F G H I J K L M N O P Q R S T U V W X Y Z

A B C D E F G H I J K L M N O P Q R S T U V W X Y Z

Tightening torques

- attachment screws for the shipping plate (removal) • 145
- Installation screws • 58

TNs • 5**Tools**

- required for wiring valves/pumps • 88

transducer connectors X2, X5...X7

- in the block diagram of the valve electronics • 20

Transducer interface

- in the block diagram of the valve electronics • 20

transportation • 52

- ambient conditions, permissible

- D671 series • 166

- D672 series • 177

- D673 series • 188

- D674 series • 199

- D675 series • 210

- transportation damage • 53

Troubleshooting • 147

- overview of possible faults • 147
- instabilities of the control loop
 - external control loop • 149
 - internal valve control loops • 149
- instability of the external control loop • 149
- leak at the linear force motor screw plug • 148
- Leak at the valve connecting surface • 147
- no hydraulic response by the valve • 148

Troubleshooting (service) • 140**TÜV** (Technischer Überwachungsverein)**Type designation**

- Command signals for 100 % spool stroke • 161
- Electrical supply • 161
- fail-safe identification • 159
- Fieldbus connectors X3 and X4 • 162
- Gasket material • 160
- Hydraulic intake/drain • 160
- on the nameplate • 154–155
- Operating pressure • 157
- pilot identification • 37
- Pilot valve • 158
- Rated flow • 157
- signal type identification • 41
- Spool position based on enable signal • 162
- Spool type • 156
- Spool version • 158

Type designation (function key) • 156**Type designation, model number** • 156**typographical conventions** • 3**U****U_{Cable}**

- voltage drop on the cable • 103

U_{Command}

- command signal of input voltage • 103

U_{dr_max}

- maximum voltage drop on the cable • 99

U_{min}

- minimum supply voltage • 99

U_{out}

- output voltage • 104

U_{in}

- input voltage • 103

USB start-up module • 130

- Ordering information D67X • 222

use, intended • 5**User manual**

- ordering information • 223
- Ordering manual D67X • 222
- prohibition to duplicate • A
- prohibition to reproduce • A
- release date • 2
- storage location • 2
- styles/spelling, used • 3
- subject to change without notice • A, 2
- symbols, used • 3
- typographical conventions • 3
- version number • 2

User manual M3000® and MSC-R

- copyright • A
- duplication prohibition • A
- reproduction prohibition • A

Users, qualified • 7**V****V** (symbol for volume)**Valve configurations** • 34–36

- 2-way operation • 34
- 2x2-way operation • 34
- hydraulic symbols
 - 2-way operation • 34
 - 2x2-way operation • 34
 - 3-way operation • 36
 - 4-way operation • 35–36

Technical Data

- D671 series • 166
- D672 series • 177
- D673 series • 188
- D674 series • 199
- D675 series • 210

Connectors X3 and X4

- in the block diagram of the valve/pump electronics • 66
- pin assignment • 78, 80, 82
- wiring CAN networks • 106–110
 - cable length and cable cross section • 109
 - interference immunity • 107
 - Procedure • 106
 - wiring diagram • 107
- wiring EtherCAT networks • 114–116
 - Procedure • 114
 - wiring diagram • 115
- wiring Profibus-DP networks • 111–113
 - cable length and cable cross section • 112
 - Procedure • 111
 - wiring diagram • 112

Connectors X5...X7

- in the block diagram of the valve/pump electronics • 66
- pin assignment • 83

A B C D E F G H I J K L M N O P Q R S T U V W X Y Z

A B C D E F G H I J K L M N O P Q R S T U V W X Y Z

Connector X1

- in the block diagram of the valve/pump electronics • 66
- pin assignment • 69
 - 6+PE-pin connector • 69
- versions • 69
- Wiring
 - 6+PE-pin connector • 102
 - 11+PE-pin connector • 102

Connector X2

- in the block diagram of the valve/pump electronics • 66
- pin assignment • 76
- wiring CAN networks • 106–110
 - cable length and cable cross section • 109
 - interference immunity • 107
 - Procedure • 106
 - wiring diagram • 107
- wiring SSI transducers • 105

Connector X8

- in the block diagram of the valve/pump electronics • 66

Connector X9

- in the block diagram of the valve/pump electronics • 66

Valve connector

- in the block diagram of the valve/pump electronics • 66
- list of interfaces • 68

Valve design

- D671 series • 166
- D672 series • 177
- D673 series • 188
- D674 series • 199
- D675 series • 210

valve electronics • 20

- block diagram • 20
- Microprocessor control • 20
 - for storing the valve software parameters • 131
- reference temperature
 - D671 series • 166
 - D672 series • 177
 - D673 series • 188
 - D674 series • 199
 - D675 series • 210

valve software • 47

- configuration of the valves • 47
 - via the fieldbus interface • 128
 - via the service interface • 130
- factory setting of the valves • 131
- Microprocessor control • 20
 - for storing the valve software parameters • 131

Valve status

- 'ACTIVE' • 21, 31–32
- 'DISABLED' • 21, 28, 30, 32, 139
- 'FAULT DISABLED' • 21, 28, 30, 32
- 'FAULT HOLD' • 21, 25, 28, 30, 32
- 'HOLD' • 21, 25, 28, 30, 32
- 'INIT' • 21, 28, 30, 32, 139
- 'NOT READY' • 21, 28, 30
- overview of the valve status • 21

Valve/pump electronics, block diagram • 66**VDE** (Verband der Elektrotechnik Elektronik Informationstechnik e. V.)**VDI** (Verein Deutscher Ingenieure e. V.)**venting**

- Hydraulic system • 133

Version number of the user manual • 2**Vibration resistance**

- D671 series • 166
- D672 series • 177
- D673 series • 188
- D674 series • 199
- D675 series • 210

Viscosity ν of the hydraulic fluid

- D671 series • 166
- D672 series • 177
- D673 series • 188
- D674 series • 199
- D675 series • 210

Voltage drop U_{Cable} on the cable • 103**W****WAF**

- widths across flats
 - attachment screws for the shipping plate • 58, 143
 - Installation screws • 58, 143

widths across flats

- attachment screws for the shipping plate • 58, 143
- Installation screws • 58, 143

Wiring

- tools and materials required • 88

X1

- 6+PE-pin connector • 102
- 11+PE-pin connector • 102

X2

- CAN network • 106
- SSI transducer • 105

X3 and X4

- CAN network • 106
- EtherCAT network • 114
- Profibus-DP network • 111

X5...X7 • 117

- 2-wire transducer • 118
- 3-wire transducer • 118
- 4-wire transducer • 118

X**X: pilot pressure port • 37****diameter**

- D671 series • 165
- D672 series • 176
- D673 series • 187
- D674 series • 198
- D675 series • 209

position in the holes in the mounting surface

- D671 series • 165
- D672 series • 176
- D673 series • 187
- D674 series • 198
- D675 series • 209

X: Ports

- in the representative depiction of the valve • 18

A B C D E F G H I J K L M N O P Q R S T U V W X Y Z

A B C D E F G H I J K L M N O P Q R S T U V W X Y Z

Y

Y: leakage port • 37

Z

zero overlap • 35, 38

Zero position of the spool

electrical zero position • 38

hydraulic zero position • 38

Zero shift

D671 series • 167

D672 series • 178

D673 series • 189

D674 series • 200

D675 series • 211

A B C D E F G H I J K L M N O P Q R S T U V W X Y Z

15 Appendix

15.1 Abbreviations, symbols and identification letters

Fig.	Explanation
β_x	Symbol for filter fineness
Δp	Symbol for pressure difference
Δp_N	Symbol for rated pressure difference
ν	Symbol for viscosity
A	Valve port (consumer port)
A	Pin of the 6+PE-pin connector X1
A/D	Analog-Digital converter
ACV	Axis Control Valve (valve with axis control function)
B	Valve port (consumer port)
B	Pin of the 6+PE-pin connector X1
C	Pin of the 6+PE-pin connector X1
CAN	Controller Area Network
CANopen	Standardized communication profile
CiA	CAN in Automation e. V. (International Manufacturers' and Users' Organization for CAN Users; http://www.can-cia.org)
D	Differential (e. g.: in PID controller)
D	Fail-safe function D of valve
D	Pin of the 6+PE-pin connector X1
D/A	Digital-Analog converter
DDV	Direct Drive Valve
DIN	Deutsches Institut für Normung e. V. (German Institute for Standardization)(http://www.din.de)
DSP	Draft Standard Proposal
E	Pin of the 6+PE-pin connector X1
EMC	Electromagnetic Compatibility
EN	Europa-Norm (European standard)
ESD	Electrostatic Discharge
EU	European Union
F	Fail-safe function F of valve
F	Pin of the 6+PE-pin connector X1
F_{1...F₄}	Bore for installation screws or attachment screws for the shipping plate in the holes of the valve mounting surface
FKM	fluorocarbon rubber (material for gaskets, such as O-rings)
G	Bore for positioning pin in the holes of the valve mounting surface
GND	Ground
HNBR	Hydrogenated Nitrile Butadiene Rubber (material for gaskets, such as O-rings)
HNBR	Hydrogenated Nitrile Butadiene Rubber (material for gaskets, such as O-rings)
I	Integral (e.g. in PID controller)
I_{in}	Symbol for input current
I_{out}	Symbol for output current
I_{Command}	Symbol for current command signal
I_{Supply}	Symbol for supply current

Tab. 47: Abbreviations, symbols, and identification letters

Tab. 47: Abbreviations, symbols and identification letters (part 1 of 3)

Fig.	Explanation
ID	Identifier
ID	Inner Diameter (e.g. on O-rings)
IEC	International Electrotechnical Commission (http://www.iec.ch)
IP	International Protection (IP code; degree of protection type by enclosure as per EN 60529)
ISM	Industrial, scientific and medical (industrial, scientific, and medical, e. g. for ISM devices)
ISO	International Organization for Standardization (http://www.iso.org)
LED	Light Emitting Diode
LSS	Layer Setting Services as per CiA DSP 305 (LSS offers the option of setting the node parameters, such as module address or transmission rate, of a CAN node via the CAN bus)
LVDT	Linear Variable Differential Transformer (position transducer; senses the position of the spool in the valve)
M	Fail-safe function M of valve
NBR	Nitrile Butadiene Rubber (material for gaskets, such as O-rings)
NBR	Nitrile Butadiene Rubber (material for gaskets, such as O-rings)
NG	Nominal size of the valve, e.g. 610
P	Proportional (e.g. in PID controller)
P	Valve port (pressure port)
P₁	Valve port (pressure port)
P_{max}	Symbol for power consumption at maximum flow
P_{min}	Symbol for power consumption with motor in neutral position
P	Symbol for pressure (P ressure)
p_N	Symbol for rated pressure
p_P	Symbol for operating pressure
p_x	Symbol for pilot pressure
PC	Personal Computer
PE	Protective Earth
PE	Pin of the 6 or 11+PE-pin connector X1
PE	Pin of the 11+PE-pin valve connector X1
PELV	Protective Extra Low Voltage
PID	Proportional Integral Differential (e. g. in PID controller)
PWM	Pulse Width Modulation
Q	Symbol for flow
Q	Symbol for flow rate of a pump
Q_L	Symbol for leakage flow
Q_{max}	Symbol for maximum flow
Q_N	Symbol for rated flow
R_a	Symbol for average roughness
R_{In}	Symbol for input resistance
R_L	Symbol for load impedance
SELV	Safety Extra Low Voltage (low voltage)
WAF	Width Across Flats for wrenches
T	Symbol for temperature
T	Valve port (tank port)
T₁	Valve port (tank port)
T	Symbol for time
TN	Technical Note

Tab. 47: Abbreviations, symbols, and identification letters

Tab. 47: Abbreviations, symbols and identification letters (part 2 of 3)

Fig.	Explanation
TÜV	Technischer Überwachungsverein (German Technical Inspection Agency)
U_{in}	Symbol for input voltage
U_{out}	Symbol for output voltage
U_{comm}	Symbol for input voltage command signal
U_{cable}	Symbol for voltage drop on the cable
USB	U niversal S erial B us
UV	U ltraviolet
V	Symbol for volume (such as tank capacity)
VDE	V erein d er E lektrotechnik E lektronik I nformationstechnik e. V. (German Association of Electrical Engineering, Electronics and Information Technology) (http://www.vde.de)
VDI	V erein D eutscher I ngenieure e. V. (Association of German Engineers) (http://www.vdi.de)
W	Fail-safe function W of valve
X	Valve port (pilot pressure port)
X1...X10	Designations for the valve connectors
Y	Valve port (leakage port)

Tab. 47: Abbreviations, symbols and identification letters (part 3 of 3)

Tab. 47: Abbreviations, symbols, and identification letters

15.2 Additional literature

15.2.1 Fundamentals of hydraulics

Findeisen, Dietmar und Findeisen, Franz:
Ölhydraulik; Springer-Verlag

**Additional literature:
fundamentals of
hydraulics**

Murrenhoff, Univ.-Prof. Dr.-Ing. Hubertus:
Grundlagen der Fluidtechnik-- Teil 1: Hydraulik (Vorlesungsumdruck des IFAS der RWTH Aachen)
<http://www.rwth-aachen.de/ifas>

Murrenhoff, Univ.-Prof. Dr.-Ing. Hubertus:
Servohydraulik (Vorlesungsumdruck des IFAS der RWTH Aachen)
<http://www.rwth-aachen.de/ifas>

Murrenhoff, Univ.-Prof. Dr.-Ing. Hubertus:
Steuerungs- und Schaltungstechnik-II (Vorlesungsumdruck des IFAS der RWTH Aachen)
<http://www.rwth-aachen.de/ifas>

Schäfer, Dr. Klaus D.:
Stetighydraulik-- Grundlagen, Ventiltechnik, Regelkreise; Die Bibliothek der Technik, Band 215; Verlag Moderne Industrie

15.2.2 CAN fundamentals

CAN in Automation e. V.:

<http://www.can-cia.org>

Additional literature:
CAN fundamentals

Etschberger, Konrad (editor):

CAN-- Controller-Area-Network-- Grundlagen, Protokolle, Bausteine, Anwendungen; Carl Hanser Verlag

Lawrenz, Wolfhard (editor):

CAN-- Controller Area Network-- Grundlagen und Praxis; Hüthig Verlag

15.2.3 Profibus fundamentals

PROFIBUS Users' Organization:

<http://www.profibus.com>

Additional literature:
Profibus fundamentals

Popp, Manfred:

PROFIBUS-DP/DPV1-- Grundlagen, Tipps und Tricks für Anwender; Hüthig Verlag

15.2.4 EtherCAT fundamentals

EtherCAT Technology Group:

<http://www.ethercat.org>

Additional literature:
EtherCAT fundamentals

15.2.5 Moog publications

Press releases:

<http://www.moog.com/industrial/news>

Additional literature:
Publications by our company

Newsletters:

<http://www.moog.com/industrial/newsletter>

Articles in technical journals:

<http://www.moog.com/industrial/articles>

Presentations and scientific publications:

<http://www.moog.com/industrial/papers>

User manuals, TNs, catalogs, and similar:

<http://www.moog.com/industrial/literature>

15.3 Quoted standards

15.3.1 CiA DSP

CiA DSP 305

CiA Draft Standard Proposal: CANopen Layer Setting Services and Protocol (LSS)

Quoted standards:
CiA DSP

15.3.2 TIA/EIA

ANSI/TIA/EIA-568-B.1

Commercial Building Telecommunications Cabling Standard Part 1: General Requirements

Quoted standards:
TIA/EIA

EIA 422

Electrical Characteristics of Balanced Voltage Digital Interface Circuits

TIA/EIA-485-A

Electrical Characteristics of Generators and Receivers for Use in Balanced Digital Multipoint Systems

15.3.3 IEC

IEC 62407

Real-time Ethernet control automation technology (EtherCAT™)

Quoted standards: IEC

15.3.4 IEEE

IEEE 802.3

Carrier Sense Multiple Access with Collision Detection (CSMA/CD) Access Method and Physical Layer

Quoted standards

15.3.5 ISO, ISO/IEC

ISO 11898

Road vehicles-- CAN protocol

Quoted standards: ISO,
ISO/IEC

ISO/IEC 8802-3

Information technology-- Telecommunications and information exchange between systems-- Local and metropolitan area networks, specific requirements-- Part 3: Carrier sense multiple access with collision detection (CSMA/CD) access method and physical layer specifications

15.3.6 DIN

DIN 51524-1

Pressure fluids; Hydraulic oils-Part 1: HL hydraulic oils; Minimum requirements

Quoted standards: DIN

DIN 51524-2

Pressure fluids; Hydraulic oils-Part 2: HLP hydraulic oils; Minimum requirements

DIN 51524-3

Pressure fluids; Hydraulic oils-Part 3: HVLP hydraulic oils; Minimum requirements

DIN 24340-2

Hydraulic valves; mounting surfaces and connecting plates for directional control valves

15.3.7 EN

EN 563

Safety of machinery— Temperatures of touchable surfaces— Ergonomics data to establish temperature limit values for hot surfaces

Quoted standards: EN

EN 982

Safety of machinery— Safety requirements for fluid power systems and their components— Hydraulics

EN 55011

Industrial, Scientific And Medical Equipment (ISM devices) - --Radio-frequency Disturbance Characteristics - --Limits And Methods Of Measurement

EN 60068-2-6

Environmental tests— Part 2: Tests; test-Fc: vibration, sinus-shaped (IEC 60068-2-6:1995 + Corrigendum 1995)

EN 60068-2-27

Environmental tests— Part 2: Tests; test-Ea and guidelines: shocks (IEC 60068-2-27:1987)

EN 60079-0

Explosive atmospheres. Equipment. General requirements - Part 0: Operating materials - general requirements

EN 60079-1

Electrical apparatus for explosive gas atmospheres - Part 1: Flameproof enclosures 'd'

EN 60079-7

Explosive atmospheres - Part 7: Equipment protection by increased safety "e"

EN 60204

Safety of machinery – Electrical equipment of machines

EN 60529

Protection types provided by enclosures (IP code)

EN 61000-6-2

Electromagnetic compatibility (EMC)— Part 6-2: Generic standards - -- Immunity to interference for industrial environments

EN 61000-6-3

Electromagnetic compatibility (EMC)— Part 6-3: Generic standards— Emitted interference for residential, commercial and light-industrial environments

EN 61000-6-4

Electromagnetic compatibility (EMC)— Part 6-4: Generic standards - -- Emitted interference for industrial environments

EN 61076-2-101

Connectors for electronic equipment— Part 2-101: circular connectors-- type specification for circular connector M8 with screw or snap locking and M12 with screw locking for low-voltage applications

EN 61558-1

Safety of power transformers, power supplies, reactors and similar products— Part 1: General requirements and tests

EN 61158-2

Digital data communication in instrumentation and control— Fieldbus for industrial control systems

EN 61558-2-6

Safety of transformers, reactors, power supply units and similar products for supply voltages up to 1100 V— Part 2-6: Special requirements and tests for safety transformers and power supplies that contain safety transformers

DIN EN 175201-804

Type specification - --Circular connectors -- Round contacts, size diameter 1.6 mm - --threaded coupling

15.3.8 EN ISO**EN ISO 1302**

Geometrical Product Specifications (GPS) - Indication of surface texture in technical product documentation

Quoted standards: EN ISO

EN ISO 4762

Hexagon socket head cap screws

EN ISO 12100

Safety of machinery— Basic concepts, general principles for design

EN ISO 13849-1

Safety of machinery – Safety-related parts of control systems – Part 1: General design principles

EN ISO 13849

Safety of machinery – Safety-related parts of control systems

15.3.9 ISO**ISO 4401**

Hydraulic fluid power— 4-port directional control valves— Mounting surfaces

Quoted standards: ISO

ISO 4406

Hydraulic fluid power— Fluids— Method for coding level of contamination by solid particles

ISO11158

Lubricants, industrial oils and related products (class L) -- Family H (hydraulic systems) -- Specifications for categories HH, HL, HM, HV and HG

15.4 Quoted directives**2006/42/EC**

Directive 2006/42/EG of the European Parliament and Council for alignment of the legal and administrative provisions of the Member States for machinery

Quoted directives

2004/108/EC

Directive 2004/108/EC concerning electromagnetic compatibility (EMC)

94/9/EG

ATEX product guideline

1999/92/EG

ATEX operating guideline



VDI offers numerous directives for downloading:
<http://www.vdi-nachrichten.com/ce-richtlinien/basics/richtlinien.asp>.

15.5 Explosion-proof connectors

Instructions from the company Cooper Crouse-Hinds GmbH

**eXLink 4-polig Stecker, Kupplung/
4-pole plug, coupler/
4 pôles fiche, prolongateur**



COOPER Crouse-Hinds

Technische Angaben

Gerätekennzeichnung nach 94/9/EG und Norm:	
	Ⓜ II 2 G Ex de IIC T6 Ⓜ II 2 G Ex ia/ib IICT6 Ⓜ II 2 D Ex tD A21 IP 66 T80°C
nach CSA	Class I, Zone 1 Ex de IIC T6 Class I, Div 2; Gr. A,B,C,D
EG-Baumusterprüfbescheinigung: PTB 03 ATEX 1016 X	
Zulässige Umgebungs- temperatur:	-25°C/-55°C bis +40°C ¹⁾
Bemessungsspannung:	bis 250 V, 50/60 Hz
Bemessungsstrom:	max. 10 A
Leitungseinführung ø:	Standard Optional
Stecker, Kupplung	ø 4-7,5 mm ø 7,5-11 mm
Anschlussquerschnitt:	1x0,75-1,5 mm ² /2,5 mm ²
Anschlussleitung	Draka ToughCat 7 LSHF-FR 4x2/0,27 MUD
Vibrationsfestigkeit nach EN 60068-2-6 10-150 Hz: 2g / 30 min ²⁾	
Prüfdrehmomente:	
Arretierungsschraube	1,0 Nm
Überwurfmutter	2,5 Nm
Druckschraube -ø 4-7,5 mm	3,5 Nm
Druckschraube -ø 7,5-11 mm	3,5 Nm

- 1) die besonderen Bedingungen gemäß Prüfschein PTB 03 ATEX 1016 X sind zu beachten.
2) Die Hinweise im Kapitel „Montage“ beachten!

Technical Data

Apparatus marking acc. to 94/9/EC & directive	
	Ⓜ II 2 G Ex de IIC T6 Ⓜ II 2 G Ex ia/ib IICT6 Ⓜ II 2 D Ex tD A21 IP 66 T80°C
acc. CSA	Class I, Zone 1 Ex de IIC T6 Class I, Div 2; Gr. A,B,C,D
EC type examination certificate: PTB 03 ATEX 1016 X	
Permissible ambient temperature:	-25°C/-55°C to +40°C ¹⁾
Rated voltage:	up to 250 V, 50/60 Hz
Rated current:	max. 10 A
Cable entry ø:	Standard Optional
Plug, coupler	ø 4-7.5 mm ø 7.5-11 mm
Terminal cross section:	1x0.75-1.5 mm ² /2.5 mm ²
Cable:	Draka ToughCat 7 LSHF-FR 4x2/0.27 MUD
Vibration resistance acc. EN 60068-2-6 10-150 Hz: 2g / 30 min ²⁾	
Test torques:	
Locking screw	1.0 Nm
Coupling nut	2.5 Nm
Pressure screw -ø 4-7,5 mm	3.5 Nm
Pressure screw -ø 7,5-11 mm	3.5 Nm

- 1) observe special requirements accd. certification PTB 03 ATEX 1016 X.
2) Follow the instructions in the chapter 'Installation'!

Caractéristiques techniques

Marquage de l'appareil selon 94/9/CE & directive	
	Ⓜ II 2 G Ex de IIC T6 Ⓜ II 2 G Ex ia/ib IICT6 Ⓜ II 2 D Ex tD A21 IP 66 T80°C
en fonction de CSA	Class I, Zone 1 Ex de IIC T6 Class I, Div 2; Gr. A,B,C,D
Attestation d'examen CE de type: PTB 03 ATEX 1016 X	
Température ambiante admissible:	-25°C/-55°C à +40°C ¹⁾
Tension nominale:	jusqu'à 250 V, 50/60 Hz
Courant nominal:	max. 10 A
Entrée de câble ø:	Standard Optional
Fiche, Prolongateur	ø 4-7,5 mm ø 7,5-11 mm
Section raccordement:	1x0,75-1,5 mm ² /2,5 mm ²
Cable:	Draka ToughCat 7 LSHF-FR 4x2/0,27 MUD
Résistance aux vibrations selon EN 60068-2-6 10-150 Hz: 2g / 30 min ²⁾	
Couples de serrage testés:	
Vis d'arrêt	1,0 Nm
Collerette de fixation	2,5 Nm
Vis de serrage ø 4-7,5 mm	3,5 Nm
Vis de serrage ø 7,5-11 mm	3,5 Nm

- 1) Respecter les précautions particulières selon l'attestation d'examen CE de type PTB 03 ATEX 1016 X
2) Suivre les instructions du chapitre 'Montage'!

Sicherheitshinweise



Vor dem Öffnen der Druckschraube am Stecker und Kupplung, ist die Spannungsfreiheit sicherzustellen. Die Montageanleitung darf nur zusammen mit der ausführlichen Betriebsanleitung „GHG5707001P0001“ (unter www.ceag.de erhältlich) verwendet werden. Die Benutzerinformationen für „MOOG-Ventile“ sind zu beachten (www.moog.com/industrial). Das Konfektionieren der Steckverbinder darf nur durch Fachkräfte erfolgen. Die Steckverbindungen eXLink sind nicht für den Einsatz in der Zone 0 oder 20 geeignet. Zur Sicherstellung des Explosionsschutzes dürfen in die Bohrungen von druckfesten Gehäusen nur Gerätestecker und Flansch-steckdosen aus Metall eingesetzt werden. Gerätestecker und Flanschsteckdosen aus Metall sind durch geeignete Maßnahmen in das Erdpotential der Gehäuse bzw. Geräte mit einzubeziehen. Die unter Spannung stehenden Steckverbindungskomponenten müssen sofort nach dem Trennen mit der Schutzkappe verschlossen werden, damit die Schutzart und damit der Explosionsschutz sichergestellt wird.

Safety instructions



Before opening the pressure screw on the plug and coupler, ensure that it has been isolated from the supply. The assembly instructions must be used in conjunction with the detailed operating instructions „GHG5707001P0001“ (available from www.ceag.de). The user information for „MOOG-Ventile“ must be observed (www.moog.com/industrial). The configuration of plug and socket systems shall only be carried out by qualified personnel. Plug and socket systems of the type eXLink are not suited for use in Zone 0 or 20 areas. In order to guarantee the explosion protection, only inlets and flange sockets made of metal may be fitted in the boreholes of flameproof enclosures. The metal flang sockets and inlets shall be incorporated in the earth potential equalization. When opened, the live plug and socket system components shall be sealed immediately after disconnection using the protective cap. Here it is necessary to ensure that it is closed correctly, otherwise the minimum degree of protection and the explosion protection are no longer guaranteed.

Instructions de sécurité



Avant de relâcher la vis de pression sur la prise et le prolongateur, vérifiez l'absence de tension. Utilisez la notice de montage uniquement en association avec les instructions détaillées de service „GHG5707001P0001“ (disponibles sur le site www.ceag.de). Les informations utilisateur pour les „MOOG-Ventile“ doivent être respectées (www.moog.com/industrial). Seul un personnel qualifié est autorisé à effectuer le branchement électrique des connecteurs mâles-femelles. Les connecteurs mâles-femelles eXLink ne conviennent pas pour une utilisation en zone 0 et 20. Afin de garantir une protection antidéflagrante, seuls des socles connecteurs et des prises de courant à bride métalliques doivent être montés dans les évidements des boîtiers à l'épreuve de la pression. Les prises à bride aux métal et les socles connecteur aux métal doivent être reliés au même potentiel. Après déconnexion, les éléments de connexion encore sous tension doivent immédiatement être protégés à l'aide d'obturateurs.

Montageanleitung / Mounting instructions / Mode d'emploi

	ohne PE-Bügel without PE-shackle sans étrier de PE		mit PE-Bügel with PE-shackle avec étrier de PE
Anschlussquerschnitt	0,75 - 1,5mm ² oder 2,5mm ²		
Cross section	0,75 - 1,5mm ² or 2,5mm ²		
Section de raccordement	0,75 - 1,5mm ² ou 2,5mm ²		

Kupplung Coupler Prolongateur

(PE -Bügel, nur 4+1)
(PE-clamp, only with 4+1)
(étrier de PE, seulement 4+1)

(PE)

95

28

6 h

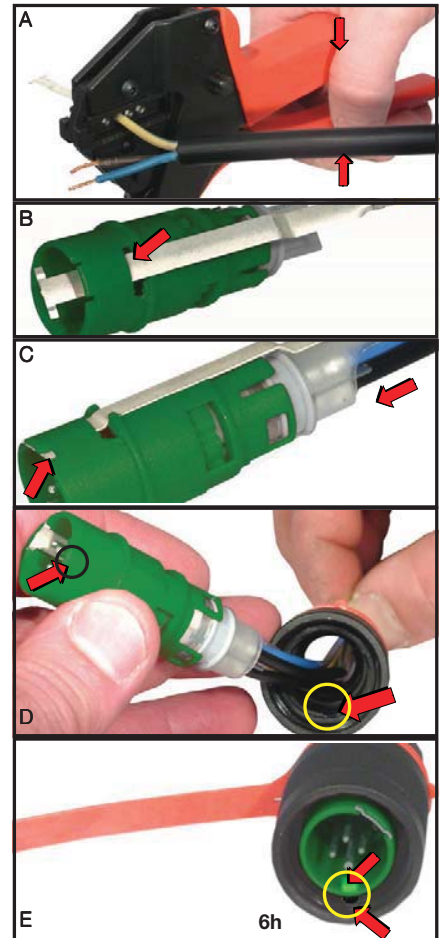

Stecker Plug Fiche

(PE -Bügel, nur 4+1)
(PE-clamp, only with 4+1)
(étrier de PE, seulement 4+1)

(PE)

Ausführung 4-polig (3+PE)
= ohne PE-Bügel

Version 4-pole (3+PE)
= without PE-clamp

Version 4 pôles (3+PE)
= sans l'étrier de PE

96

28

1 h 5 h

6 h 10 h

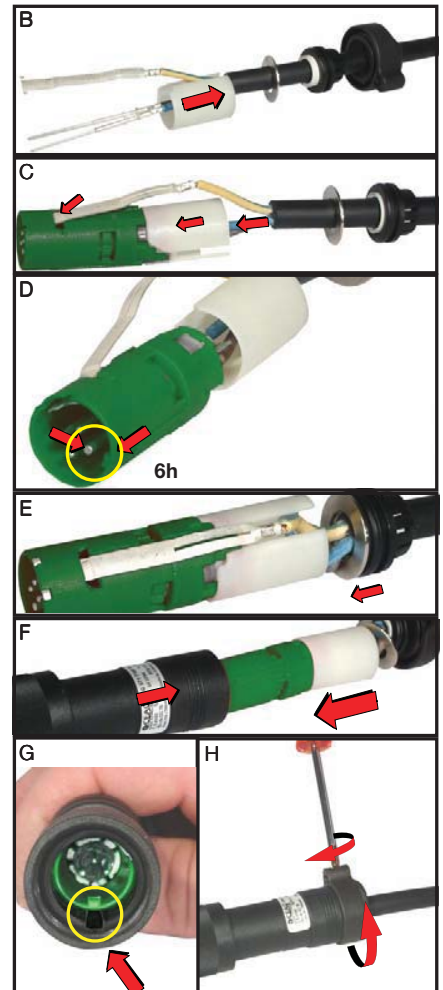

Stecker/Kupplung öffnen

1. Eventuell vorhandene Schutzkappe abschrauben.
2. Arretierschraube lösen.
3. Druckstück aus Hülse herausdrehen.
4. Einsatz von vorne aus der Hülse herausdrücken.
5. Dabei Zugentlastung, Dichtung, Druckscheibe, Isolierhülse aus Hülse nach hinten heraus nehmen.
6. Farbring zur Kennzeichnung auf Hülse aufziehen.

Leiter mit Stiften / Buchsen verbinden

⚠ Die Isolation des Leiters muss bis an die Stifte / Buchsen heranreichen. Der Leiter darf nicht beschädigt sein.

1. Kabel ca. 30 mm abmanteln.(Fig.1)
2. Leiter des Kabels ca. 8 mm abisolieren.

Stifte / Buchsen anschließen

1. Leiter in die Anschlussöffnung der Stifte / Buchsen stecken.
2. Alle Leiter mit der Crimpzange (→ Zubehör) ancrimpen (Fig.A) oder
Alle Leiter mit Stiften/Buchsen verlöten und
Schrumpfschlauch über jede Lötstelle ziehen.

Stecker/Kupplung montieren

⚠ Auch Stifte/Buchsen montieren, die nicht angeschlossen sind.

! Die Stifte/Buchsen sind nach dem Eindringen in den Einsatz nicht mehr demontierbar.

1. Druckstück, Zugentlastung, Dichtung und Druckscheibe auf Kabel aufschieben.
2. Der Stift/die Buchse der Position 4 hat einen größeren Durchmesser. Diesen zuerst in seine Halterung stecken. Alle Stifte / Buchsen bis zum hörbaren Einrasten in die Sechskantführung des Einsatzes drücken.
3. Isolierhülse auf Einsatz schieben.
4. Einsatz mit Führungsnase in die Führungsnut der Hülse stecken (Fig.G).
5. Druckscheibe, Dichtung, Zugentlastung montieren.
6. Druckstück (2) festschrauben (Drehmoment -> Technische Daten).
7. Arretierschraube festschrauben (Fig. H).

Plug open

1. Screw down possible existing protective cap. .
2. Loosen locking screw.
3. Screw out pressure piece of plug sleeve.
4. Press out from front plug insert out of plug sleeve.
5. At the same time, remove the strain relief, seal, thrust washer and insulating sleeve from the plug sleeve from the back.
6. Fit coloured ring used for marking on to the plug sleeve.

Connecting conductors to pins

⚠ The insulation of the conductor shall reach up to the pins. The conductor must not be damaged.

1. Strip off ca. 30 mm of cable insulation.(Fig.1)
2. Strip off ca. 8 mm of insulation from cable conductors.

Crimp plugs/contacts

1. Insert conductor into the connection opening of the plug/contact pin.
2. Crimp on all conductors using crimping tool (→ Accessories) [Fig.A] or
solder all conductors to plug pins/contact and pull shrink-on sleeve over each solder ring point.

Assembling plugs/coupler

⚠ Also assemble plug/coupler pins that are not connected.

! Once they have been pressed into the plug/coupler insert, the plug pins cannot be disassembled.

1. Push pressure piece, strain relief, seal and thrust washer on to cable.
2. The plug/contact pin, Item 4, is larger in diameter. To avoid mistakes, put this into the holder first. Push all the plug pins into the hexagonal keyways of the plug/coupler insert until they engage.
3. Push the insulating sleeve on to the plug insert.
4. Insert the plug insert with guide lug into the keyway of the plug sleeve (Fig.G).
5. Fit thrust washer, seal and strain relief.
6. Screw pressure piece tight [torque -> Technical Data]
7. Tighten locking screw (Fig. H).

Ouverture de la fiche

1. Dévisser le capuchon (si monté) de la fiche.
2. Dévisser la vis d'arrêt.
3. Sortir en la tournant la pièce de pression de la douille de fiche.
4. Extraire par l'avant le bloc de fiche de la douille de fiche.
5. Retirer pendant cette opération par l'arrière la décharge de tension, le joint, la rondelle de pression, la douille isolante de la douille de fiche.
6. Monter la bague en couleur comme repère sur la douille de fiche.

Raccordement des conducteurs aux contacts mâles/femelles

⚠ L'isolation du conducteur doit arriver jusqu'aux contacts . Le conducteur ne doit pas être endommagé.

1. Dénuder le câble sur env. 30 mm.(Fig.1)
2. Dénuder les conducteurs du câble sur env. 8 mm.

Présertir Fiche/Prolongateur

1. Enficher le conducteur dans l'ouverture du contact mâle/femelle.
2. Pré-sertir tous les conducteurs avec la pince à sertir (→ accessoire) (Fig.A) ou
braser tous les conducteurs avec les contacts mâles/femelles et enfile la gaine thermorétractable sur chaque brasure.

Montage de la fiche/du prolongateur

⚠ Monter aussi les contacts mâles/femelles non raccordés.

! Les contacts mâles/femelles ne peuvent plus être démontés après avoir été pressés dans le bloc de fiche.

1. Monter la pièce de pression, la décharge de tension.
2. Le contact mâle/femelle de la position 4 a un plus gros diamètre. Pour éviter toute confusion, enficher celui-ci en premier dans son support. Enfoncer tous les contacts mâles/femelles jusqu'à l'enclenchement dans le guidage hexagonal du bloc de fiche.
3. Monter la douille isolante sur le bloc de fiche.
4. Engager le bloc de fiche avec l'ergot de guidage dans la rainure de guidage de la douille de fiche (Fig.G).
5. Monter la rondelle de pression, le joint, la décharge de tension.
6. Visser la pièce de pression (couple -> Caractéristiques techniques).
7. Visser la vis d'arrêt (Fig. H).

Handhabung

- A/A1** Den Stecker mit der Führungsnase lagerichtig in die entsprechende Führungsnut der Kupplung bis zum 1. Anschlag einstecken (**B**).
- B1** Danach den Stecker um ca. 30° nach rechts bis zum Begrenzungsanschlag drehen.
- C** Stecker bis zum Endanschlag mit der Kupplung zusammenstecken.
- D** Überwurfmutter „handfest“ an der gesteckten Steckverbindung.

Handling

- A/A1** Insert the plug into the coupler until they reach the 1st stop. Ensure that the position of the key on the plug corresponds to that of the keyway on the coupler (**B**).
- B1** Then turn the plug to the right through ca. 30° until it reaches the stop.
- C** Insert plug into coupler until it reaches the final stop.
- D** Tighten the coupling nut on the connected plug and socket.

Manoeuvre

- A/A1** Introduisez la fiche en positionnant correctement l'ergot de guidage dans la rainure de guidage correspondante du prolongateur jusqu'à la 1^{ère} butée (**B**).
- B1** Ensuite, tournez la fiche d'environ 30° vers la droite jusqu'en butée de limitation.
- C** Assemblez la fiche et le prolongateur jusqu'en butée.
- D** Vissez à fond la collerette de fixation sur le connecteur enfiché.

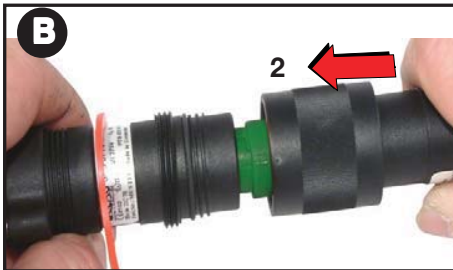
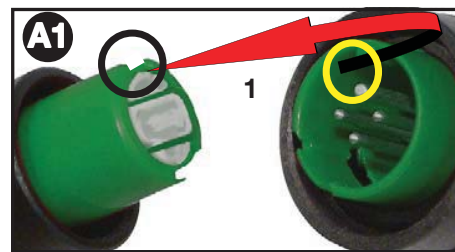
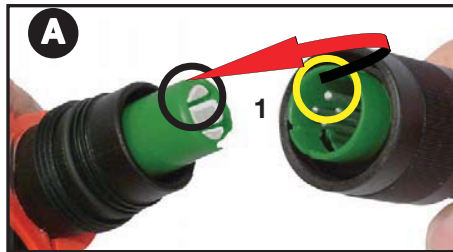

Normenkonformität

Das Steckverbindungssystem entspricht den in der Konformitätserklärung aufgeführten Normen und den vergleichbaren IEC Standards
IEC 60079-0, IEC 60079-1, IEC 60079-7, IEC 61241-0, IEC 61241-1.
CAN/CSA C22.2 E60079-0-02
CAN/CSA C22.2 E60079-1-02
CAN/CSA C22.2 E60079-7-2003
CAN/CSA C22.2 No 213
CAN/CSA C22.2 No 182.3 M1987
CAN/CSA C22.2 No 94.1-07
94/9 EG: Geräte und Schutzsysteme zur bestimmungsgemäßen Verwendung in explosionsgefährdeten Bereichen.
Das Steckverbindungssystem ist gemäß DIN EN ISO 9001 entwickelt, gefertigt und geprüft worden.

Conformity with standards

The plug and socket system is conform to the standards specified in the EC-Declaration of conformity and additional conform to the comparable IEC Standards
IEC 60079-0, IEC 60079-1, IEC 60079-7, IEC 61241-0, IEC 61241-1.
CAN/CSA C22.2 E60079-0-02
CAN/CSA C22.2 E60079-1-02
CAN/CSA C22.2 E60079-7-2003
CAN/CSA C22.2 No 213
CAN/CSA C22.2 No 182.3 M1987
CAN/CSA C22.2 No 94.1-07
94/9 EC: Equipment and protective systems intended for use in potentially explosive atmospheres.
It has been designed, manufactured and tested according to the state of the art and to DIN EN ISO 9001.

Conformité avec les normes

Les boîtes à bornes sont conformes aux normes reprises dans la déclaration de conformité et supplémentaires conformes à la comparables aux IEC Standards
IEC 60079-0, IEC 60079-1, IEC 60079-7, IEC 61241-0, IEC 61241-1.
CAN/CSA C22.2 E60079-0-02
CAN/CSA C22.2 E60079-1-02
CAN/CSA C22.2 E60079-7-2003
CAN/CSA C22.2 No 213
CAN/CSA C22.2 No 182.3 M1987
CAN/CSA C22.2 No 94.1-07
94/9 CE: Appareils et systèmes de protection destinés à être utilisés en atmosphère explosible.
Les boîtes à bornes ont été conçues, fabriquées et contrôlées suivant DIN EN ISO 9001.

Wir / we / nous

**Cooper Crouse-Hinds GmbH
Neuer Weg-Nord 49
D-69412 Eberbach**

erklären in alleiniger Verantwortung, dass die
*hereby declare in our sole responsibility, that the
déclarons de notre seule responsabilité, que le*

Mehrfachsteckverbindung eXLink 4-/5-polig
*multiple plug and socket systems eXLink, 4-/5-pole
multiple fiches et prises eXLink, à 4-/5-pôles*

⊕ II 2 G Ex de IIC T6 // ⊕ II 2 G Ex ia/ib IIC T6
⊕ II 2 D Ex tD A21 IP66 T80°C

Typ GHG 57.

auf die sich diese Erklärung bezieht, mit den folgenden Normen oder normativen Dokumenten übereinstimmen.
*which are the subject of this declaration, are in conformity with the following standards or normative documents.
auquel cette déclaration se rapporte, est conforme aux normes ou aux documents normatifs suivants.*

Bestimmungen der Richtlinie
Terms of the directive
Prescription de la directive

Titel und / oder Nr. sowie Ausgabedatum der Norm.
Title and / or No. and date of issue of the standard.
Titre et / ou No. ainsi que date d'émission des
normes.

94/9/EG: Geräte und Schutzsysteme zur bestimmungs-
gemäßen Verwendung in explosionsgefährdeten
Bereichen.

EN 60 079-0: 2006
EN 60 079-1: 2004
EN 60 079-7: 2007
EN 60 079-11: 2007

94/9/EC: Equipment and protective systems intended for
use in potentially explosive atmospheres.

EN 61 241-0: 2006
EN 61 241-1: 2004
EN 60 529: 1991 + A1: 2000
EN 61 984: 2001
EN 60 999-1: 2000

94/9/CE: Appareils et systèmes de protection destinés à
être utilisés en atmosphère explosibles.

2004/108 EG: Elektromagnetische Verträglichkeit
2004/108 EC: *Electromagnetic compatibility*
2004/108 CE: *Compatibilité électromagnétique*

EN 60 947-1: 2007

Eberbach, den 04.07.2008

Ort und Datum
*Place and date
Lieu et date*

i.A. R. Brandel
Leiter Labor
*Head of Laboratory
Chef du dépt. Laboratoire*

i.V. H. Huter
Leiter Approbation
*Head of Approval office
Chef du dépt. approbation*

PTB 96 ATEX Q 1 - 4

Zertifizierungsstelle
*Notified Body of the certification
Organes Notifié et Compétent*

Physikalisch-Technische Bundesanstalt (0102)
Bundesallee 100
D-38116 Braunschweig

Konformitätsbewertungsstelle
*Notified Body to quality evaluation
Organes d'attestation de conformité*

Physikalisch-Technische Bundesanstalt (0102)
Bundesallee 100
D-38116 Braunschweig

Für den sicheren Betrieb des Betriebsmittels sind die Angaben der zugehörigen Betriebsanleitung zu beachten.
*For the safe use of this apparatus, the informations given in the accompanying operating instructions must be followed.
Afin d'assurer le bon fonctionnement de nos appareils, prière de respecter les directives du mode d'emploi correspondent à ceux-ci.*

**eXLink 4-polig Gerätestecker, Flanschsteckdose/
4-pole Inlet, Flange/
4 la prise et le prolongateur**



COOPER Crouse-Hinds

Technische Angaben

Gerätekenzeichnung nach 94/9/EG:	⊕ II 2G Ex de IIC T6/ ⊕ II 2G Ex ia/ib IIC T6 ⊕ II 2D tD A21 IP66 T80°C
nach CSA	Class I, Zone 1 Ex de IIC T6 Class I, Div 2; Gr. A,B,C,D
Zulässige Umgebungstemperatur:	-25°C/-55°C bis +40°C ¹⁾
EG-Baumusterprüfbescheinigung:	PTB 03 ATEX 1016 X
Bemessungsspannung:	bis 250 V, 50/60 Hz
Bemessungsstrom:	max. 10 A
Anschlussquerschnitt:	AWG 22, AWG 26
Anschlussleitung:	AWG 22/26 Metrofunk
Vibrationsfestigkeit nach EN 60068-2-6 10-150 Hz:	2g / 30 min ²⁾
Prüfdrehmomente	
Arretierungsschraube:	1,0 Nm
Einschraubgewinde Steckdose, Gerätestecker:	30 Nm
Überwurfmutter:	2,5 Nm (handfest)

- 1) die besonderen Bedingungen gemäß Prüfschein PTB 03 ATEX 1016 X sind zu beachten.
2) Die Hinweise im Kapitel „Montage“ beachten!

Technical Data

Apparatus marking acc. to 94/9/EC:	⊕ II 2G Ex de IIC T6/ ⊕ II 2G Ex ia/ib IIC T6 ⊕ II 2D tD A21 IP66 T80°C
acc. CSA	Class I, Zone 1 Ex de IIC T6 Class I, Div 2; Gr. A,B,C,D
Permissible ambient temperature:	-25°C/-55°C to +40 °C ¹⁾
EC type examination certificate:	PTB 03 ATEX 1016 X
Rated voltage:	up to 250 V, 50/60 Hz
Rated current:	max. 10 A
Terminal cross section:	AWG 22, AWG 26
Cable:	AWG 22/26 Metrofunk
Vibration resistance acc. EN 60068-2-6 10-150 Hz:	2g / 30 min ²⁾
Test torques	
Locking screw:	1.0 Nm
Screw-in thread - flange socket, inlet:	30 Nm
coupling nut:	2,5 Nm (by hand)

- 1) observe special requirements accd. certification PTB 03 ATEX 1016 X.
2) Follow the instructions in the chapter 'Installation'!

Caractéristiques techniques

Marquage de l'appareil selon 94/9/CE:	⊕ II 2G Ex de IIC T6/ ⊕ II 2G Ex ia/ib IIC T6 ⊕ II 2D tD A21 IP66 T80°C
en fonction de CSA	Class I, Zone 1 Ex de IIC T6 Class I, Div 2; Gr. A,B,C,D
Température ambiante admissible:	-25°C/-55°C à +40°C ¹⁾
Attestation d'examen CE de type:	PTB 03 ATEX 1016 X
Tension nominale:	jusqu'à 250 V, 50/60 Hz
Courant nominal:	max. 10 A
Section raccordement:	AWG 22, AWG 26
Cable:	AWG 22/26 Metrofunk
Résistance aux vibrations selon EN 60068-2-6 10-150 Hz:	2g / 30 min ²⁾
Couples de serrage testés	
Vis d'arrêt:	1,0 Nm
Filets de vis de prise à pride, connecteur:	30 Nm
Ecrou(Bien serrer à la main):	2,5 Nm

- 1) Respecter les précautions particulières selon l'attestation d'examen CE de type PTB 03 ATEX 1016 X
2) Suivre les instructions du chapitre 'Montage'!

Sicherheitshinweise



Vor dem Öffnen der Druckschraube am Stecker und Kupplung, ist die Spannungsfreiheit sicherzustellen.

Die Montageanleitung darf nur zusammen mit der ausführlichen Betriebsanleitung „GHG5707001P0001“ (unter www.ceag.de erhältlich) verwendet werden.

Die Benutzerinformationen für „MOOG-Ventile“ sind zu beachten (www.Moog.com/industrial).

Das Konfektionieren der Steckverbinder darf nur durch Fachkräfte erfolgen.

Die Gewindebohrungen im druckfesten Schutzgehäuse oder Einbaugeräten, müssen den Mindestanforderungen der EN 60079-1, entsprechen.

Die Steckverbindungen eXLink sind nicht für den Einsatz in der Zone 0 oder 20 geeignet.

Zur Sicherstellung des Explosionsschutzes dürfen in die Bohrungen von druckfesten Gehäusen nur Gerätestecker und Flanschsteckdosen aus Metall eingesetzt werden.

Gerätestecker und Flanschsteckdosen aus Metall sind durch geeignete Maßnahmen in das Erdpotential der Gehäuse bzw. Geräte mit einzubeziehen.

Steckverbindung nur in technisch einwandfreiem Zustand sowie bestimmungsgemäß, sicherheits- und gefahrenbewusst unter Beachtung dieser Montage- und Betriebsanleitung montieren und betreiben.

Die unter Spannung stehenden Steckverbindungskomponenten müssen sofort nach dem Trennen mit der Schutzkappe verschlossen werden, damit die Schutzart und damit der Explosionsschutz sichergestellt wird.

Safety instructions



Before opening the pressure screw on the plug and coupler, ensure that it has been isolated from the supply.

The assembly instructions must be used in conjunction with the detailed operating instructions “GHG5707001P0001” (available from www.ceag.de).

The user information for „MOOG-Ventile“ must to be observed. (www.Moog.com/industrial).

The connection of plug and socket systems shall only be carried out by qualified personnel.

The threaded holes in the flameproof enclosure shall fulfil the minimum requirements of EN 60079-1.

Plug and socket systems of the type eXLink are not suited for use in zone 0 or 20 areas.

In order to guarantee the explosion protection, only inlets and flange sockets made of metal may be fitted in the boreholes of flameproof enclosures.

The metal flang sockets and inlets shall be incorporated in the earth potential equalization.

They shall be used for their intended purpose and shall be in an undamaged and perfect state.

When opened, the live plug and socket system components shall be sealed immediately after disconnection using the protective cap.

Here it is necessary to ensure that it is closed correctly, otherwise the minimum degree of protection and the explosion protection are no longer guaranteed.

Instructions de sécurité



Avant de relâcher la vis de pression sur la prise et le prolongateur, vérifiez l'absence de tension.

Utilisez la notice de montage uniquement en association avec les instructions détaillées de service “GHG5707001P0001” (disponibles sur le site www.ceag.de).

Les informations utilisateur pour les „MOOG-Ventile“ doivent être respectées. (www.Moog.com/industrial).

Seul un personnel qualifié est autorisé à effectuer le branchement électrique des connecteurs mâles-femelles.

Les alésages filetés du boîtier de protection ou appareil à encastrer résistant à la pression doivent satisfaire aux exigences minima de la norme EN 60079-1.

Les connecteurs mâles-femelles eXLink ne conviennent pas pour une utilisation en zone 0 et 20.

Afin de garantir une protection antidéflagrante, seuls des socles connecteurs et des prises de courant à bride métalliques doivent être montés dans les évidements des boîtiers à l'épreuve de la pression.

Les prises à bride aux métal et les sockles connecteur aux métal doivent être reliés au même potentiel.

N'utilisez les prises de courant à bride et socles connecteurs qu'avec les fiches et prolongateurs correspondants et en parfait état.

Après déconnexion, les éléments de connexion encore sous tension doivent immédiatement être protégés à l'aide d'obturateurs.

Handhabung

- A/A1** Den Stecker mit der Führungsnase lagerichtig in die entsprechende Führungsnut der Kupplung bis zum 1. Anschlag einstecken **(B)**.
- B1** Danach den Stecker um ca. 30° nach rechts bis zum Begrenzungsanschlag drehen.
- C** Stecker bis zum Endanschlag mit der Kupplung zusammenstecken.
- D** Die Überwurfmutter des Steckers über die Kupplung schieben und handfest festschrauben.

Handling

- A/A1** Insert the plug into the coupler until they reach the 1st stop. Ensure that the position of the key on the plug corresponds to that of the keyway on the coupler **(B)**.
- B1** Then turn the plug to the right through ca. 30° until it reaches the stop.
- C** Insert plug into coupler until it reaches the final stop.
- D** Slide the coupling nut of the plug over the coupler and tighten well by hand

Manoeuvre

- A/A1** Introduisez la fiche en positionnant correctement l'ergot de guidage dans la rainure de guidage correspondante du prolongateur jusqu'à la 1^{ère} butée **(B)**.
- B1** Ensuite, tournez la fiche d'environ 30° vers la droite jusqu'en butée de limitation.
- C** Assemblez la fiche et le prolongateur jusqu'en butée.
- D** Enfiler l'écrou de la prise sur le prolongateur et bien serrer à la main.

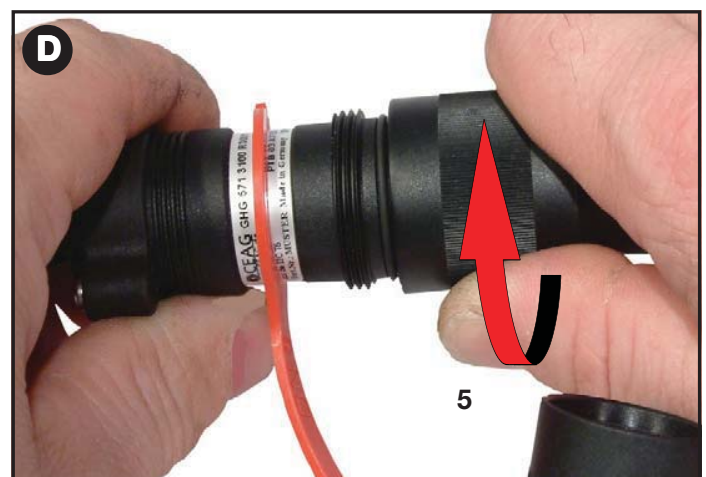
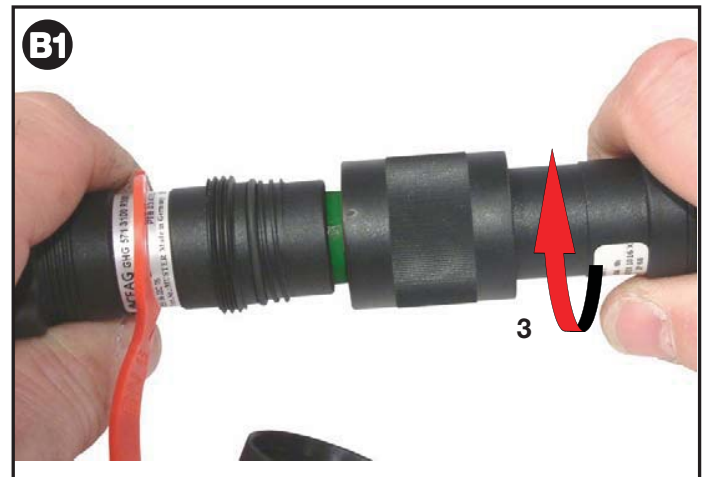
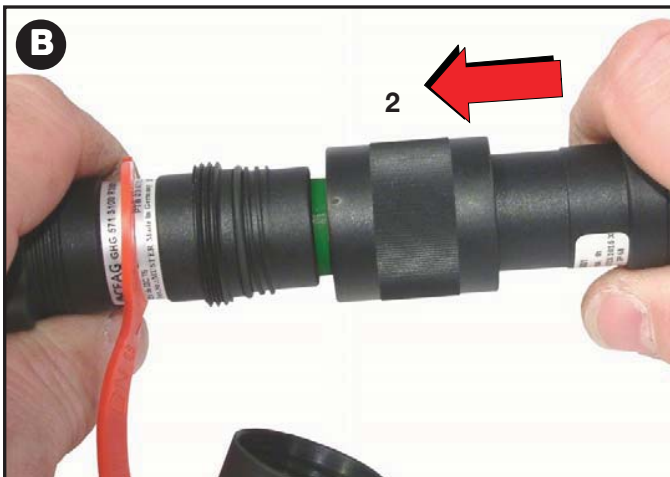
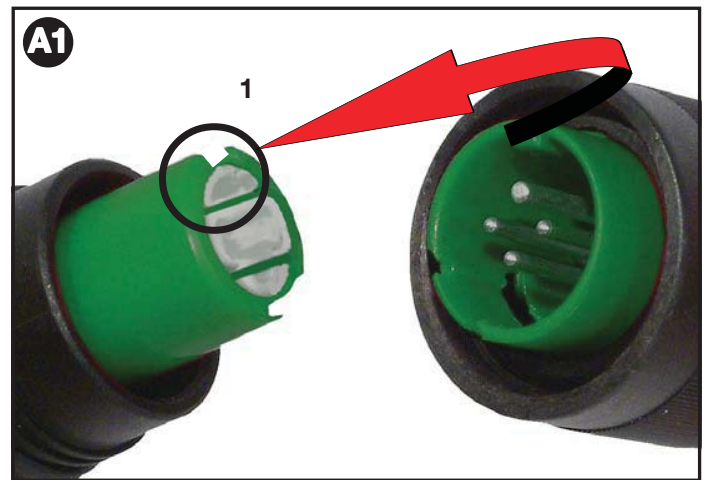
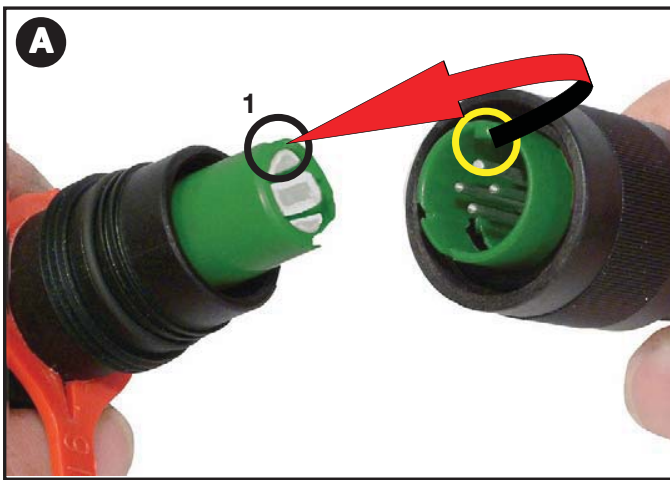

Montage / Mounting / Montage

Gerätestecker mit Anschlussleitung
Inlet with connection leads
Socle connecteur avec lignes de raccordement

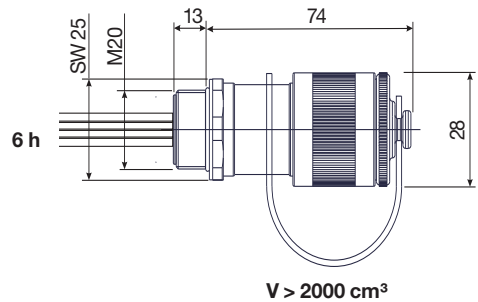
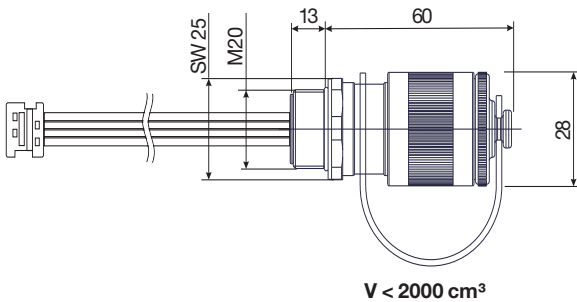

Flanschsteckdose mit Anschlussleitung
Flange socket with connection leads
Prise à bride avec lignes de raccordement

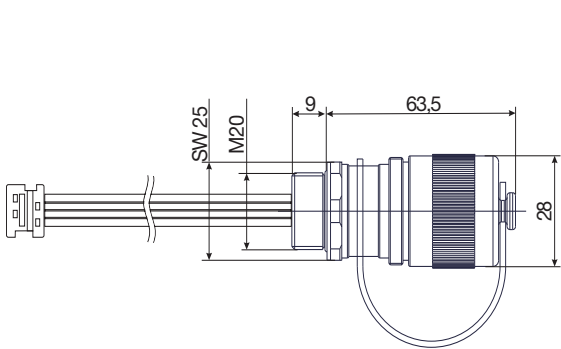

Das Gehäusevolumen bei der Auswahl des Gerätesteckers berücksichtigen.

Observe the flameproof enclosure volume when flange-socket selecting.

Observez le volume de l'enceinte antidéflagrante lors socle connecteur avec sélection.

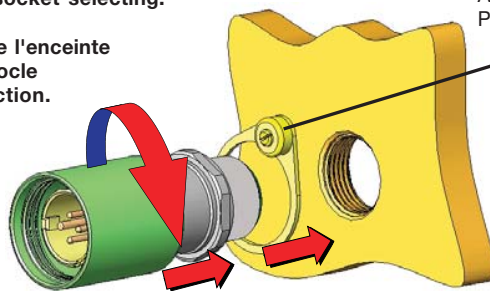

Verdrehungsschutz - optional
 Anti-torsion protection - optionally
 Protection anti-torsion - facultatif

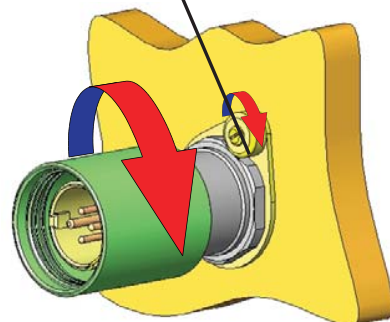

Flanschsteckdosen, oder Gerätestecker müssen durch geeignete Maßnahmen (z.B. Einkleben, Kontern (Prüfdrehmoment 30 Nm) oder Arretieren mit einem Verdrehungsschutz gegen Verdrehen oder Selbstlockern gesichert werden.

Suitable measures shall be applied (e.g. adhesive, locking (Test torques 30 Nm) and retaining with anti-torsion protection) to safeguard screwed-in flange sockets, inlets or angle pieces against twisting or self-loosening.

Une fois vissés, les prises à brides ou socles connecteurs doivent être bloqués par un moyen approprié (par ex. collage, contre-écrou (Couples de serrage testés 30 Nm) et blocage par protection anti-torsion) pour les empêcher de tourner ou de se dévisser.

Normenkonformität

Das Steckverbindingssystem entspricht den in der Konformitätserklärung aufgeführten Normen und den vergleichbaren IEC Standards IEC 60079-0, IEC 60079-1, IEC 60079-7, IEC 61241-0, IEC 61241-1.
CAN/CSA C22.2 E60079-0-02
CAN/CSA C22.2 E60079-1-02
CAN/CSA C22.2 E60079-7-2003
CAN/CSA C22.2 No 213
CAN/CSA C22.2 No 182.3 M1987
CAN/CSA C22.2 No 94.1-07
94/9 EG: Geräte und Schutzsysteme zur bestimmungsgemäßen Verwendung in explosionsgefährdeten Bereichen.
Das Steckverbindingssystem ist gemäß DIN EN ISO 9001 entwickelt, gefertigt und geprüft worden.

Conformity with standards

The plug and socket system is conform to the standards specified in the EC-Declaration of conformity and additional conform to the comparable IEC Standards IEC 60079-0, IEC 60079-1, IEC 60079-7, IEC 61241-0, IEC 61241-1.
CAN/CSA C22.2 E60079-0-02
CAN/CSA C22.2 E60079-1-02
CAN/CSA C22.2 E60079-7-2003
CAN/CSA C22.2 No 213
CAN/CSA C22.2 No 182.3 M1987
CAN/CSA C22.2 No 94.1-07
94/9 EC: Equipment and protective systems intended for use in potentially explosive atmospheres.
It has been designed, manufactured and tested according to the state of the art and to DIN EN ISO 9001.

Conformité avec les normes

Les boîtes à bornes sont conformes aux normes reprises dans la déclaration de conformité et supplémentaires conformes à la comparables aux IEC Standards IEC 60079-0, IEC 60079-1, IEC 60079-7, IEC 61241-0, IEC 61241-1.
CAN/CSA C22.2 E60079-0-02
CAN/CSA C22.2 E60079-1-02
CAN/CSA C22.2 E60079-7-2003
CAN/CSA C22.2 No 213
CAN/CSA C22.2 No 182.3 M1987
CAN/CSA C22.2 No 94.1-07
94/9 CE: Appareils et systèmes de protection destinés à être utilisés en atmosphère explosible.
Les boîtes à bornes ont été conçues, fabriquées et contrôlées suivant DIN EN ISO 9001.

	EG-Konformitätserklärung EC-Declaration of conformity CE-Déclaration de conformité PTB 03 ATEX 1016 X
	GHG 900 1000 P0010 D
Wir / we / nous	Cooper Crouse-Hinds GmbH Neuer Weg-Nord 49 D-69412 Eberbach
erklären in alleiniger Verantwortung, dass die <i>hereby declare in our sole responsibility, that the déclarons de notre seule responsabilité, que le</i>	Mehrfachsteckverbinding eXLink 4-/5-polig <i>multiple plug and socket systems eXLink, 4-/5-pole multiple fiches et prises eXLink, à 4-/5-pôles</i>
Ⓢ II 2 G Ex de IIC T6 // Ⓢ II 2 G Ex ia/Ib IIC T6 Ⓢ II 2 D Ex tD A21 IP66 T80°C	Typ GHG 57.
auf die sich diese Erklärung bezieht, mit den folgenden Normen oder normativen Dokumenten übereinstimmen. <i>which are the subject of this declaration, are in conformity with the following standards or normative documents. auquel cette déclaration se rapporte, est conforme aux normes ou aux documents normatifs suivants.</i>	
Bestimmungen der Richtlinie Terms of the directive Prescription de la directive	Titel und / oder Nr. sowie Ausgabedatum der Norm. Title and / or No. and date of issue of the standard. Titre et / ou No. ainsi que date d'émission des normes.
94/9/EG: Geräte und Schutzsysteme zur bestimmungsgemäßen Verwendung in explosionsgefährdeten Bereichen.	EN 60 079-0: 2006 EN 60 079-1: 2004 EN 60 079-7: 2007 EN 60 079-11: 2007
94/9/EC: Equipment and protective systems intended for use in potentially explosive atmospheres.	EN 61 241-0: 2006 EN 61 241-1: 2004 EN 60 529: 1991 + A1: 2000
94/9/CE: Appareils et systèmes de protection destinés à être utilisés en atmosphère explosibles.	EN 61 984: 2001 EN 60 999-1: 2000
2004/108 EG: Elektromagnetische Verträglichkeit 2004/108 EC: Electromagnetic compatibility 2004/108 CE: Compatibilité électromagnétique	EN 60 947-1: 2007
Eberbach, den 04.07.2008	 I.A. R. Brandel Leiter Labor Head of Laboratory Chef du dépt. Laboratoire
Ort und Datum Place and date Lieu et date	 I.V. H. Huter Leiter Approval Head of Approval office Chef du dépt. approbation
	PTB 96 ATEX Q 1 - 4
Zertifizierungsstelle Notified Body of the certification Organes Notifié et Compétent	Physikalisch-Technische Bundesanstalt (0102) Bundesallee 100 D-38116 Braunschweig
Konformitätsbewertungsstelle Notified Body to quality evaluation Organes d'attestation de conformité	Physikalisch-Technische Bundesanstalt (0102) Bundesallee 100 D-38116 Braunschweig
Für den Sicheren Betrieb des Betriebsmittels sind die Angaben der zugehörigen Betriebsanleitung zu beachten. <i>For the safe use of this apparatus, the informations given in the accompanying operating instructions must be followed. Afin d'assurer le bon fonctionnement de nos appareils, prière de respecter les directives du mode d'emploi correspondant à ceux-ci.</i>	
	

Cooper Crouse-Hinds GmbH

Neuer Weg-Nord 49
D-69412 Eberbach
Phone +49 (0) 6271/806-500
Fax +49 (0) 6271/806-476
Internet: www.CEAG.de
E-Mail: info-ex@ceag.de

**eXLink 6+1-polig Stecker, Kupplung/
6+1-pole plug, coupler /
6+1 la fiche, prolongateur**



COOPER Crouse-Hinds

Technische Angaben

Gerätekenzeichnung nach 94/9/EG: II 2 G Ex de IIC T6
 II 2 G Ex ia/ib IIC T6
nach CSA Class I, Zone 1 Ex de IIC T6 Class I, Div 2; Gr. A,B,C,D

EG-Baumusterprüfbescheinigung:	PTB 06 ATEX 1031 X
Zulässige Umgebungstemperatur:	-25°C/-55°C bis 40°C ¹⁾
Bemessungsspannung:	bis 400 V, 50/60 Hz
Bemessungsstrom:	max. 16 A
Leitungseinführung ø:	Standard Optional
Stecker, Kupplung	ø7-11mm ø11-15mm
Anschlussleitung:	LEONI 7x0,75mm ² , MUD
Anschlussquerschnitt:	1x0,75-1,5mm ² / 2,5mm ²
Vibrationsfestigkeit nach EN 60068-2-6 10-150 Hz:	2g / 30 min ²⁾
Prüfdrehmomente:	Metall
Arretierungsschraube	1,0 Nm
Einschraubgewinde Steckdose, Gerätestecker	3,5 Nm
Druckschraube	3,5 Nm
Druckschraube	3,5 Nm

Technical Data

Apparatus marking acc. to 94/9/EC: II 2 G Ex de IIC T6
 II 2 G Ex ia/ib IIC T6
acc. CSA Class I, Zone 1 Ex de IIC T6 Class I, Div 2; Gr. A,B,C,D

EC type examination certificate:	PTB 06 ATEX 1031 X
Permissible ambient temperature:	-25°C/-55°C to +40 °C ¹⁾
Rated voltage:	up to 400 V, 50/60 Hz
Rated current:	max. 16 A
Cable entry ø:	Standard Optional
Plug, coupler	ø7-11mm ø11-15mm
Cable:	LEONI 7x0,75mm ² , MUD
Terminal cross section:	1x0,75-1,5mm ² / 2,5mm ²
Vibration resistance acc. EN 60068-2-6 10-150 Hz:	2g / 30 min ²⁾
Test torques:	
Locking screw	1.0 Nm
Screw-in thread - flange socket, inlet	3.5 Nm
Pressure screw	3.5 Nm
Pressure screw	3.5 Nm

Caractéristiques techniques

Marquage de l'appareil selon 94/9/CE: II 2 G Ex de IIC T6
 II 2 G Ex ia/ib IIC T6
en fonction de CSA Class I, Zone 1 Ex de IIC T6 Class I, Div 2; Gr. A,B,C,D

Attestation d'examen CE de type:	PTB 06 ATEX 1031 X
Température ambiante admissible:	-25°C/-55°C à +40°C ¹⁾
Tension nominale:	jusqu'à 400 V, 50/60 Hz
Courant nominal:	max. 16 A
Entrée de câble ø:	Standard Optional
Fiche, Prolongateur	ø7-11mm ø11-15mm
Cable:	LEONI 7x0,75mm ² , MUD
Section raccordement:	1x0,75-1,5mm ² / 2,5mm ²
Résistance aux vibrations selon EN 60068-2-6 10-150 Hz:	2g / 30 min ²⁾
Couples de serrage testés:	
Vis d'arrêt	1,0 Nm
Filets de vis de prise à pride, connecteur	3,5 Nm
Vis de serrage	3,5 Nm
Vis de serrage	3,5 Nm

- 1) die besonderen Bedingungen gemäß Prüfschein PTB 03 ATEX 1016 X sind zu beachten.
- 2) Die Hinweise im Kapitel „Montage“ beachten!

- 1) observe special requirements accd. certification PTB 03 ATEX 1016 X.
- 2) Follow the instructions in the chapter 'Installation

- 1) Respecter les précautions particulières selon l'attestation d'examen CE de type PTB 03 ATEX 1016 X
- 2) Suivre les instructions du chapitre 'Montage!

Sicherheitshinweise

Zielgruppen dieser Anleitung sind Elektrofachkräfte und unterwiesene Personen in Anlehnung an die IEC 60079-14.

*Die Montageanleitung nur zusammen mit der ausführlichen Betriebsanleitung „GHG5707005P0001“ (unter www.ceag.de erhältlich) verwenden.
Die Benutzerinformationen für „MOOG-Ventile“ sind zu beachten (www.Moog.com/industrial).*

Die auf den Geräten angegebene Temperaturklasse und Zündschutzart ist zu beachten.

Die Steckverbindung ist nicht für den Einsatz im explosionsgefährdeten Bereich der Zone 0 und Zone 20, 21, 22 gemäß EN 60079-10 geeignet.

Steckverbinder unter Last nur mit den Werten der Technischen Daten betreiben.

Trennen unter Belastung maximal bis 230 V / 400 V, 10 A möglich.

Steckverbindung nur in technisch einwandfreiem Zustand sowie bestimmungsgemäß, sicherheits- und gefahrenbewusst unter Beachtung dieser Montage- und Betriebsanleitung montieren und betreiben.

Beachten Sie die nationalen Sicherheits- und Unfallverhütungsvorschriften und die nachfolgenden Sicherheitshinweise in dieser Betriebsanleitung, die wie dieser Text in Kursivschrift gefasst sind!

Safety instructions

Operations shall be carried out by electricians and suitably personnel trained in hazardous area with knowledge of increased safety explosion protection in accordance with IEC 60079-14.

*The assembly instructions must be used in conjunction with the detailed operating instructions “GHG5707005P0001” (available from www.ceag.de).
The user information for „MOOG-Ventile“ must to be observed (www.Moog.com/industrial).*

The temperature class and explosion group marked on the terminal boxes have to be observed.

The plug and socket system is not suitable for Zone 0 and zone 20, 21, 22 hazardous areas accordance with IEC 60079-10.

The plug and socket system may only be connected or disconnected under load acc. to technical data. (230 V / 400 V max. 10 A)

These assembly and operating instructions shall be observed when installing and operating the plug and socket connector system. It shall only be used in a technically perfect state and in accordance with the intended purpose while paying attention to the particular safety and hazard aspects.

The national safety rules and regulations for the prevention of accidents, as well as the safety instructions included in these operating instructions, that, like this text, are set in italics, shall be observed!

Consignes de sécurité

Ce mode d'emploi s'adresse aux électriciens et personnes initiées sur base de la norme CEI 60079-14.

*Utilisez la notice de montage uniquement en association avec les instructions détaillées de service “GHG5707005P0001” (disponibles sur le site www.ceag.de).
Les informations utilisateur pour les „MOOG-Ventile“ doivent être respectées (www.Moog.com/industrial).*

Le groupe d'explosion et la classe de température marqués sur les appareils devront être respectés.

Le connecteur n'est pas conçu pour être utilisé dans les atmosphères explosibles des zones 0 et 20, 21, 22 conformément à CEI 60079-10.

Respecter impérativement les valeurs indiquées dans les caractéristiques techniques pour les connecteurs sous charge. Ne séparer qu'à 230 V / 400 V 10 A

Monter et utiliser le connecteur seulement s'il présente un état technique parfait, conformément à sa destination, en étant conscient des risques et des mesures de sécurité à appliquer dans le respect d es présentes instructions de montage et de service.

Tenir compte des prescriptions nationales en matière de sécurité et de prévention des accidents ainsi que des consignes de sécurité indiquées dans ce mode d'emploi, écrites en italiques comme ce texte !

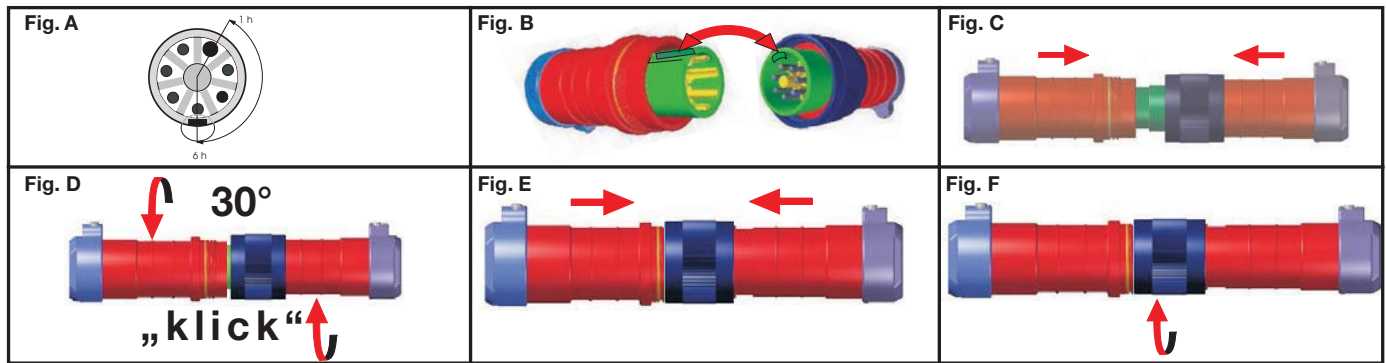

Verwendung/Eigenschaften

Die auf den Steckverbindern angegebene Temperaturklasse und Zündschutzart beachten.

Steckverbindung unter Last nur mit den Werten der Technischen Daten betreiben und trennen.

Die Verantwortung hinsichtlich bestimmungsgemäßer Verwendung der Steckverbindung unter Bezugnahme der in dieser Montage- und Betriebsanleitung vorhandenen Rahmenbedingungen (Technischen Daten) liegt allein beim Betreiber.

Keine Veränderungen bzw. Umbauten an der Steckverbindung vornehmen.

Jede andere Verwendung ist nicht bestimmungsgemäß.

COOPER Crouse-Hinds übernimmt keine Haftung für Schäden, die aus nicht bestimmungsgemäßer Verwendung entstehen.

Steckverbindung stecken/trennen

⚠ Die Flanschsteckdosen und Gerätestecker nur mit den zugehörigen unbeschädigten Steckern und Kupplungen betreiben.

⚠ Auf gleiche Codierung (Uhrzeit) der Steckverbindung achten.

i Der Winkel zwischen Führungsnase und PE Stift (mit größerem Durchmesser) ergibt die Uhrzeit. (Fig. A)

Steckverbindung stecken

1. Der Stecker bzw. Gerätestecker mit der Führungsnase lagerichtig in die entsprechende Führungsnute der Kupplung bzw. Flanschsteckdose stecken. (Fig. B)
2. Bis zum 1. Anschlag zusammenstecken. (Fig. C)
3. Stecker bzw. Gerätestecker gegen Kupplung bzw. Flanschsteckdose ca. 30° gegeneinander bis zum Anschlag verdrehen. (Fig. D)
4. Steckverbindung vollständig zusammenstecken. (Fig. E)

i Die elektrische Verbindung des Stecksystems ist jetzt hergestellt.

5. Überwurfmutter des Steckers andrücken und festschrauben.

⚡ IP Schutz und die mechanische Verbindung hergestellt. (Fig. F)

Steckverbindung trennen

1. Steckverbindung in umgekehrter Reihenfolge zum Stecken trennen.

⚠ Bei nicht korrektem Stecken der Steckverbindungskomponenten ist der Explosionsschutz nicht mehr gewährleistet.

Use / Properties

The temperature class and type of protection stated on the apparatus shall be observed.

The plug and socket system may only be operated and disconnected under load acc. to the technical data.

The sole responsibility with respect to the suitability and proper use of the plug and socket systems with regard to the basic requirements of these instructions (see Technical Data) lies with the operator.

Plug and socket systems shall be checked in accordance with Section 6 of the named instructions, before being put into use.

Modifications or changes to the design of the plug and socket systems are not permitted. Applications other than described are not permitted without COOPER CROUSE-HINDS's prior written consent.

CCH takes no responsibility for damages caused by incorrect use.

Connection/disconnection of plug and socket

⚠ The flange sockets and inlets shall only be operated with the associated, undamaged plugs and couplers.

⚠ Attention shall be paid that the coding (time setting) of the plugs and sockets is the same.

i The time of day is the angle between the guide lug and the PE pin (larger in diameter). (Fig. A)

Connecting plug and socket

1. Insert the plug or inlet with the guide lug in the correct position into the respective keyway of the coupler or flange socket. (Fig. B)
2. Insert until 1st stop is reached. (Fig. C)
3. Turn plug or inlet through ca. 30° in relation to the coupler or flange socket until the stop is reached. (Fig. D)
4. Join plug and socket completely. (Fig. E)

i The electrical connection has now been made.

5. Press the coupling nut of the plug on and screw it tight.

⚡ The IP degree of protection and the mechanical connection are established by tightening the coupling nut. (Fig. F)

Disconnecting plug and socket

1. To disconnect plug and socket, carry out the above actions in the reverse order.

⚠ When opened, the live plug and socket system components shall be sealed immediately after disconnection using the protective cap.

Utilisation / Propriétés

Observez la classe de température et le type de protection indiqués sur les appareils.

Respecter impérativement les valeurs indiquées dans les caractéristiques techniques lors de l'utilisation et du débranchement du connecteur.

En cas d'utilisation non conforme de ce dispositif de connexion, par référence aux conditions de base du présent mode d'emploi (caractéristiques techniques), l'exploitant en supporterait seul la responsabilité.

Contrôler le connecteur avant la mise en service conformément aux instructions mentionnées dans la section 6.

Ne pas modifier ou transformer le connecteur.

Utiliser exclusivement des pièces d'origine du fabricant pour les remplacements et réparations.

Toute autre utilisation s'avère non conforme. COOPER Crouse Hinds décline toute responsabilité pour des dommages.

Branchement/Débranchement du connecteur

⚠ N'utiliser les prises de courant à bride et les socles connecteurs qu'avec des fiches et prolongateurs compatibles intacts.

⚠ Veiller à un codage identique (heure) du connecteur.

i L'angle entre l'ergot de guidage et le contact mâle PE (d'un plus grand diamètre) donne l'heure. (Fig. A)

Branchement du connecteur

1. Engager dans la bonne position la fiche/le socle connecteur avec l'ergot de guidage dans la rainure de guidage correspondante du prolongateur/de la prise de courant à bride. (Fig. B)
2. Brancher les deux éléments jusqu'à la butée 1
3. Tourner dans des sens contraires, d'env. 30°, la fiche/le socle connecteur et le prolongateur/la prise de courant à bride jusqu'en butée. (Fig. D)
4. Le connecteur mâle-femelle boucher tout à fait. (Fig. E)

i Le branchement électrique du système de connexion est maintenant réalisé.

5. Appuyer l'écrou-raccord de la fiche et le visser.

⚡ Le vissage de l'écrou-raccord a pour effet d'établir la protection IP et la liaison mécanique. (Fig. F)

Débranchement du connecteur

1. Débrancher le connecteur dans l'ordre inverse du branchement.

⚠ Les éléments de connexion conducteurs de tension à l'état ouvert doivent être fermés avec le capuchon dès le débranchement.

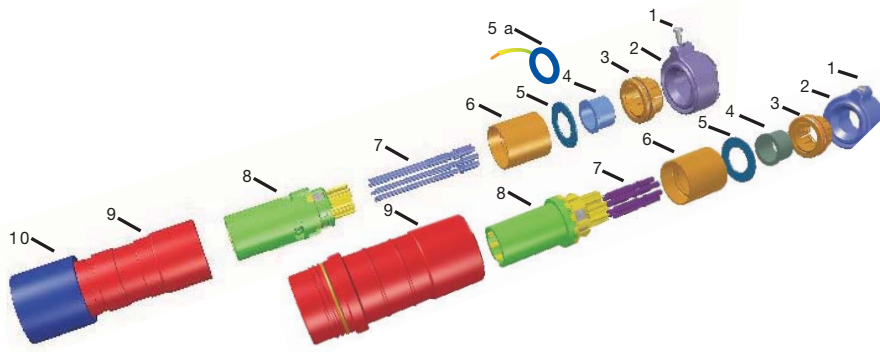

- 1 Arretierschraube
- 2 Druckstück
- 3 Zugentlastung
- 4 Dichtung
- 5 Druckscheibe
- 5a Druckscheibe mt PE
- 6 geteilte Isolierhülse
- 7 Stift / Buchse
- 8 Einsatz
- 9 Hülse
- 10 Überwurfmutter

- 1 Locking screw
- 2 Pressure piece
- 3 Strain relief
- 4 Seal
- 5 Thrust washer
- 5a Thrust washer with PE
- 6 Insulating sleeve divisible
- 7 Plug pins / contact sockets
- 8 Plug/Coupler insert
- 9 Plug/Coupler sleeve
- 10 Coupling nut

- 1 Vis d'arrêt
- 2 Pièce de pression
- 3 Décharge de tension
- 4 Joint
- 5 Rondelle de pression
- 5a Rondelle de pression avec un pe
- 6 Douille isolante
- 7 Contact mâle/femelle
- 8 Bloc de fiche/prolongateur à insérer
- 9 Douille de fiche/prolongateur
- 10 Ecou-raccord

Kupplung

Coupler

Prolongateur

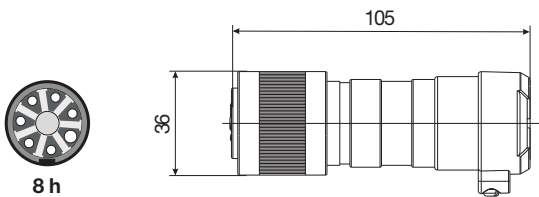

Stecker

Plug

Fiche

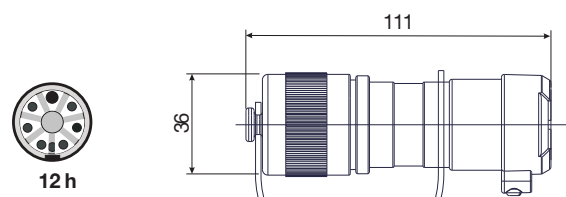

Stecker/Kupplung öffnen

1. Eventuell vorhandene Schutzkappe abschrauben.
2. Arretierschraube (1) lösen.
3. Druckstück (2) aus Hülse (9) herausdrehen.
4. Einsatz (8) von vorne aus der Hülse (9) herausdrücken.
5. Dabei Zugentlastung (3), Dichtung (4), Druckscheibe (5), Isolierhülse (6) aus Hülse (9) nach hinten heraus nehmen.
6. Farbring zur Kennzeichnung auf Hülse (9) aufziehen.

Plug open (Fig. 7.1)

1. Screw down possible existing protective cap. .
2. Loosen locking screw (1).
3. Screw out pressure piece (2) of plug sleeve (9).
4. Press out from front plug insert (8) out of plug sleeve (9).
5. At the same time, remove the strain relief (3), seal (4), thrust washer (5) and insulating sleeve (6) from the plug sleeve (9) from the back.
6. Fit coloured ring used for marking on to the plug sleeve (9).

Ouverture de la fiche

1. Dévisser le capuchon (si monté) de la fiche.
2. Dévisser la vis d'arrêt (1).
3. Sortir en la tournant la pièce de pression (2) de la douille de fiche (9).
4. Extraire par l'avant le bloc de fiche (8) de la douille de fiche (9).
5. Retirer pendant cette opération par l'arrière la décharge de tension (3), le joint (4), la rondelle de pression (5), la douille isolante (6) de la douille de fiche (9).
6. Monter la bague en couleur comme repère sur la douille de fiche (9).

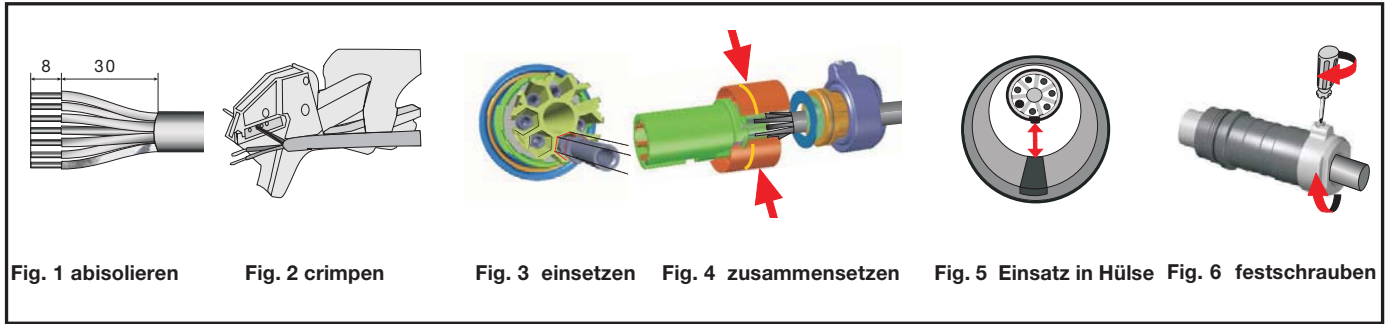

Fig. 1 abisolieren

Fig. 2 crimpen

Fig. 3 einsetzen

Fig. 4 zusammensetzen

Fig. 5 Einsatz in Hülse

Fig. 6 festschrauben

Leiter mit Stiften / Buchsen verbinden

⚠ Die Isolation des Leiters muss bis an die Stifte / Buchsen heranreichen. Der Leiter und die Isolation dürfen nicht beschädigt sein.

1. Kabel ca. 30 mm abmanteln.(Fig.1)
2. Leiter des Kabels ca. 8 mm abisolieren.

Stifte / Buchsen anschließen

1. Leiter in die Anschlussöffnung der Stifte / Buchsen (7) stecken.
2. Alle Leiter mit der Crimpzange (→ Zubehör) ancrimpen (Fig.2).
oder
Alle Leiter mit Stiften/Buchsen verlöten und Schrumpfschlauch über jede Lötstelle ziehen.

Stecker/Kupplung montieren

⚠ Auch Stifte/Buchsen montieren, die nicht angeschlossen sind.

! Die Stifte/Buchsen sind nach dem Eindrücken in den Einsatz nicht mehr demontierbar.

Connecting conductors to pins

⚠ The insulation of the conductor shall reach up to the pins. The conductor and the insulation must not be damaged.

1. Strip off ca. 30 mm of cable insulation.(Fig.1)
2. Strip off ca. 8 mm of insulation from cable conductors.

Crimp plugs/contacts

1. Insert conductor into the connection opening of the plug/contact pin (7).
2. Crimp on all conductors using crimping tool (→ Accessories) [Fig.2] or solder all conductors to plug pins/contact and pull shrink-on sleeve over each solder ring point.

Assembling plugs/coupler

⚠ Also assemble plug/coupler pins that are not connected.

! Once they have been pressed into the plug/coupler insert, the plug pins cannot be disassembled.

Raccordement des conducteurs aux contacts mâles/femelles

⚠ L'isolation du conducteur doit arriver jusqu'aux contacts . Le conducteur et isolementne doit pas être endommagé.

1. Dénuder le câble sur env. 30 mm.(Fig.1)
2. Dénuder les conducteurs du câble sur env. 8 mm.

Présertir Fiche/Prolongateur

1. Enficher le conducteur dans l'ouverture du contact mâle/femelle (7).
2. Pré-sertir tous les conducteurs avec la pince à sertir (→ accessoire) (Fig.2).
ou
braser tous les conducteurs avec les contacts mâles/femelles et enfiler la gaine thermorétractable sur chaque brasure.

Montage de la fiche/du prolongateur

⚠ Monter aussi les contacts mâles/femelles non raccordés.

! Les contacts mâles/femelles ne peuvent plus être démontés après avoir été pressés dans le bloc de fiche.

1. Druckstück (2), Zugentlastung (3), Dichtung (4) und Druckscheibe (5) auf Kabel aufschieben.
2. Der Stift/die Buchse der Position 7 hat einen größeren Durchmesser. Diesen zuerst in seine Halterung stecken. Alle Stifte / Buchsen (7) bis zum hörbaren Einrasten in die Sechskantführung des Einsatzes (8) drücken (Fig.3).
3. Isolierhülse (6) auseinander ziehen und um die Leiter bis zum Einrasten wieder zusammendrücken (Fig.3).
4. Isolierhülse (6) auf Einsatz (8) schieben.
5. Einsatz (8) mit Führungsnase in die Führungsnut der Hülse (10) stecken (Fig.4).
6. Druckscheibe (5), Dichtung (4), Zugentlastung (3) montieren.
7. Druckstück (2) festschrauben (Drehmoment -> Technische Daten).
8. Arretierschraube (1) festschrauben.

1. Push pressure piece (2), strain relief (3), seal (4) and thrust washer (5) on to cable.
2. The plug/contact pin, Item 7, is larger in diameter. To avoid mistakes, put this into the holder first. Push all the plug pins (7) into the hexagonal keyways of the plug/coupler insert until they engage [Fig.3].
3. Pull the insulating sleeve (6) apart and press the conductors together again until they engage [Fig.3].
4. Push the insulating sleeve (6) on to the plug insert (8).
5. Insert the plug insert (8) with guide lug into the keyway of the plug sleeve (9) [Fig.4].
6. Fit thrust washer (5), seal (4) and strain relief (3).
7. Screw pressure piece (2) tight [torque -> Technical Data]
8. Tighten locking screw (1).

1. Monter la pièce de pression (2), la décharge de tension (3),
2. Le contact mâle/femelle de la position 7 a un plus gros diamètre. Pour éviter toute confusion, enficher celui-ci en premier dans son support. Enfoncer tous les contacts mâles/femelles (7) jusqu'à l'enclenchement dans le guidage hexagonal du bloc de fiche (8) (Fig.3).
3. Ecarter la douille isolante (6) puis la comprimer autour des conducteurs jusqu'à l'enclenchement (Fig.3).
4. Monter la douille isolante (6) sur le bloc de fiche (8).
5. Engager le bloc de fiche (8) avec l'ergot de guidage dans la rainure de guidage (10) de la douille de fiche (Fig.4).
6. Monter la rondelle de pression (5), le joint (4), la décharge de tension (3).
7. Visser la pièce de pression (2) (couple -> Caractéristiques techniques).
8. Visser la vis d'arrêt (1).

Normenkonformität

Das Steckverbindingssystem entspricht den in der Konformitätserklärung aufgeführten Normen und den vergleichbaren IEC Standards
IEC 60079-0, IEC 60079-1, IEC 60079-7, IEC 61241-0, IEC 61241-1.
CAN/CSA C22.2 E60079-0-02
CAN/CSA C22.2 E60079-1-02
CAN/CSA C22.2 E60079-7-2003
CAN/CSA C22.2 No 213
CAN/CSA C22.2 No 182.3 M1987
CAN/CSA C22.2 No 94.1-07
94/9 EG: Geräte und Schutzsysteme zur bestimmungsgemäßen Verwendung in explosionsgefährdeten Bereichen. Das Steckverbindingssystem ist gemäß DIN EN ISO 9001 entwickelt, gefertigt und geprüft worden.

Conformity with standards

The plug and socket system is conform to the standards specified in the EC-Declaration of conformity and additional conform to the comparable IEC Standards
IEC 60079-0, IEC 60079-1, IEC 60079-7, IEC 61241-0, IEC 61241-1.
CAN/CSA C22.2 E60079-0-02
CAN/CSA C22.2 E60079-1-02
CAN/CSA C22.2 E60079-7-2003
CAN/CSA C22.2 No 213
CAN/CSA C22.2 No 182.3 M1987
CAN/CSA C22.2 No 94.1-07
94/9 EC: Equipment and protective systems intended for use in potentially explosive atmospheres. It has been designed, manufactured and tested according to the state of the art and to DIN EN ISO 9001

Conformité avec les normes

Les boîtes à bornes sont conformes aux normes reprises dans la déclaration de conformité et supplémentaires conformes à la comparables aux IEC Standards
IEC 60079-0, IEC 60079-1, IEC 60079-7, IEC 61241-0, IEC 61241-1.
CAN/CSA C22.2 E60079-0-02
CAN/CSA C22.2 E60079-1-02
CAN/CSA C22.2 E60079-7-2003
CAN/CSA C22.2 No 213
CAN/CSA C22.2 No 182.3 M1987
CAN/CSA C22.2 No 94.1-07
94/9 CE: Appareils et systèmes de protection destinés à être utilisés en atmosphère explosible. Les boîtes à bornes ont été conçues, fabriquées et contrôlées suivant DIN EN ISO 9001.

Wir / we / nous

**Cooper Crouse-Hinds GmbH
Neuer Weg-Nord 49
D-69412 Eberbach**

erklären in alleiniger Verantwortung, dass die
*hereby declare in our sole responsibility, that the
déclarons de notre seule responsabilité, que le*

Mehrfachsteckverbindung eXLink 6-/7-polig
*multiple plug and socket systems eXLink, 6-/7-pole
multiple fiches et prises eXLink, à 6-/7-pôles*

Ⓢ II 2 G Ex de IIC T6 // Ⓢ II 2 G Ex ia/ib IIC T6

Typ GHG 57.

auf die sich diese Erklärung bezieht, mit den folgenden Normen oder normativen Dokumenten übereinstimmen.
*which are the subject of this declaration, are in conformity with the following standards or normative documents.
auquel cette déclaration se rapporte, est conforme aux normes ou aux documents normatifs suivants.*

Bestimmungen der Richtlinie
Terms of the directive
Prescription de la directive

Titel und / oder Nr. sowie Ausgabedatum der Norm.
Title and / or No. and date of issue of the standard.
Titre et / ou No. ainsi que date d'émission des normes.

94/9/EG: Geräte und Schutzsysteme zur bestimmungs-
gemäßen Verwendung in explosionsgefährdeten
Bereichen.

EN 60 079-0: 2004
EN 60 079-1: 2004
EN 60 079-7: 2004
EN 60 079-11: 2007

94/9/EC: Equipment and protective systems intended for
use in potentially explosive atmospheres.

EN 60 529: 1991 + A1: 2000
EN 61 984: 2001
EN 60 999-1: 2000

94/9/CE: Appareils et systèmes de protection destinés à
être utilisés en atmosphère explosibles.

2004/108 EG: Elektromagnetische Verträglichkeit
2004/108 EC: *Electromagnetic compatibility*
2004/108 CE: *Compatibilité électromagnétique*

EN 60 947-1: 2007

Eberbach, den 17.09.09

Ort und Datum
Place and date
Lieu et date

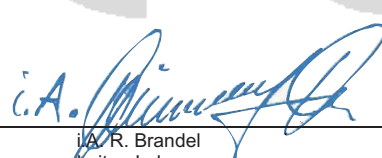
i.A. R. Brandel
Leiter Labor
Head of Laboratory
Chef du dépt. Laboratoire

i.V. H. Huter
Leiter Approbation
Head of Approval office
Chef du dépt. approbation

PTB 96 ATEX Q 1 - 5

Zertifizierungsstelle
Notified Body of the certification
Organes Notifié et Compétent

Physikalisch-Technische Bundesanstalt (0102)
Bundesallee 100
D-38116 Braunschweig

Konformitätsbewertungsstelle
Notified Body to quality evaluation
Organes d'attestation de conformité

Physikalisch-Technische Bundesanstalt (0102)
Bundesallee 100
D-38116 Braunschweig

Für den Sicheren Betrieb des Betriebsmittels sind die Angaben der zugehörigen Betriebsanleitung zu beachten.
*For the safe use of this apparatus, the informations given in the accompanying operating instructions must be followed.
Afin d'assurer le bon fonctionnement de nos appareils, prière de respecter les directives du mode d'emploi correspondant à ceux-ci.*

**eXLink 6+1-polig Geratestecker, Flanschsteckdose/
6+1-pole Inlet, Flange/
6+1 la prise et le prolongateur**



COOPER Crouse-Hinds

Technische Angaben

Geratekennzeichnung nach 94/9/EG:	Ex II 2G Ex de IIC T6/ Ex II 2G Ex ia/ib IIC T6
nach CSA	Class I, Zone 1 Ex de IIC T6 Class I, Div 2; Gr. A,B,C,D
EG-Baumusterprufbescheinigung:	PTB 06 ATEX 1031 X
Zulassige Umgebungstemperatur:	-25°C/-55°C bis +40°C ¹⁾
Bemessungsspannung:	bis 400 V, 50/60 Hz
Bemessungsstrom:	max. 16 A
Anschlussleitung:	AWG22 Metrofunk AWG26 Metrofunk
Anschlussquerschnitt:	AWG22, AWG26
Vibrationsfestigkeit nach EN 60068-2-6 10-150 Hz:	2g / 30 min ²⁾
Prufdrehmomente:	
Arretierungsschraube:	1,0 Nm
Einschraubgewinde Steckdose, Geratestecker	30 Nm
uberwurfmutter:	2,5 Nm (handfest)

Technical Data

Apparatus marking acc. to 94/9/EC:	Ex II 2G Ex de IIC T6/ Ex II 2G Ex ia/ib IIC T6
acc. CSA	Class I, Zone 1 Ex de IIC T6 Class I, Div 2; Gr. A,B,C,D
EC type examination certificate:	PTB 06 ATEX 1031 X
Permissible ambient temperature:	-25°C/-55°C to +40 °C ¹⁾
Rated voltage:	up to 400 V, 50/60 Hz
Rated current:	max. 16 A
Cable:	AWG22 Metrofunk AWG26 Metrofunk
Terminal cross section:	AWG22, AWG26
Vibration resistance acc. EN 60068-2-6 10-150 Hz:	2g / 30 min ²⁾
Test torques	
Locking screw:	1.0 Nm
Screw-in thread - flange socket, inlet:	30 Nm
coupling nut:	2,5 Nm (by hand)

Caractéristiques techniques

Marquage de l'appareil selon 94/9/CE:	Ex II 2G Ex de IIC T6/ Ex II 2G Ex ia/ib IIC T6
en fonction de CSA	Class I, Zone 1 Ex de IIC T6 Class I, Div 2; Gr. A,B,C,D
Attestation d'examen CE de type:	PTB 06 ATEX 1031 X
Température ambiante admissible:	-25°C/-55°C à +40°C ¹⁾
Tension nominale:	jusqu'à 400 V, 50/60 Hz
Courant nominal:	max. 16 A
Cable:	AWG22 Metrofunk AWG26 Metrofunk
Section raccordement:	AWG22, AWG26
Résistance aux vibrations selon EN 60068-2-6 10-150 Hz:	2g / 30 min ²⁾
Couples de serrage testés	
Vis d'arrêt:	1,0 Nm
Filets de vis de prise à pride, connecteur:	30 Nm
Ecrou(Bien serrer à la main):	2,5 Nm

- 1) Die besonderen Bedingungen gemäß Prufschein PTB 03 ATEX 1016 X sind zu beachten.
2) Die Hinweise im Kapitel „Montage“ beachten!

- 1) observe special requirements accd. certification PTB 03 ATEX 1016 X.
2) Follow the instructions in the chapter 'Installation'

- 1) Respecter les précautions particulières selon l'attestation d'examen CE de type PTB 03 ATEX 1016 X
2) Suivre les instructions du chapitre 'Montage!'

Sicherheitshinweise

Zielgruppen dieser Anleitung sind Elektrofachkrafte und unterwiesene Personen in Anlehnung an die EN/IEC 60079-14.
Die Montageanleitung nur zusammen mit der ausfuhrlichen Betriebsanleitung „GHG5707005P0001“ (unter www.ceag.de erhaltlich) verwenden.
Die Benutzerinformationen fur „MOOG-Ventile“ sind zu beachten (www.Moog.com/industrial).
Das Konfektionieren der Steckverbinder darf nur durch Fachkrafte erfolgen.
Die auf den Geraten angegebene Temperaturklasse und Zundschutzart ist zu beachten.
Die Steckverbindung ist nicht fur den Einsatz im explosionsgefahrdeten Bereich der Zone 0 und Zone 20, 21, 22 gemaß EN60079-10 geeignet.
Steckverbinder unter Last nur mit den Werten der Technischen Daten betreiben.
Trennen unter Belastung maximal bis 230 V / 400 V , 10 A moglich.
Geratestecker und Flanschsteckdosen aus Metall sind durch geeignete Manahmen in das Erdpotential der Gehause bzw. Gerate mit einzubeziehen. Steckverbindung nur in technisch einwandfreiem Zustand sowie bestimmungsgemaß, sicherheits- und gefahrenbewusst unter Beachtung dieser Montage- und Betriebsanleitung montieren und betreiben.
Die unter Spannung stehenden Steckverbindungskomponenten mussen sofort nach dem Trennen mit der Schutzkappe verschlossen werden, damit die Schutzart und damit der Explosionschutz sichergestellt wird.

Safety instructions

Operations shall be carried out by electricians and suitably personnel trained in hazardous area with knowledge of increased safety explosion protection in accordance with IEC 60079-14.
The assembly instructions must be used in conjunction with the detailed operating instructions “GHG5707005P0001” (available from www.ceag.de).
The user information for „MOOG-Ventile“ must to be observed.
The connection of plug and socket systems shall only be carried out by qualified personnel.
The temperature class and explosion group marked on the terminal boxes have to be observed.
The plug and socket system is not suitable for Zone 0 and zone 20, 21, 22 hazardous areas accordance with EN 60079-10.
The plug and socket system may only be connected or disconnected under load acc. to technical data. (230 V / 400 V max. 10 A). The metal flang sockets and inlets shall be incorporated in the earth potential equalization.
These assembly and operating instructions shall be observed when installing and operating the plug and socket connector system. It shall only be used in a technically perfect state and in accordance with the intended purpose while paying attention to the particular safety and hazard aspects.
The national safety rules and regulations for the prevention of accidents, as well as the safety instructions included in these operating instructions, that, like this text, are set in italics, shall be observed! Here it is necessary to ensure that it is closed correctly, otherwise the minimum degree of protection and the explosion protection are no longer guaranteed.

Consignes de sécurité

Ce mode d'emploi s'adresse aux electriciens et personnes initiées sur base de la norme CEI60079-14.
Utilisez la notice de montage uniquement en association avec les instructions détaillées de service “GHG5707005P0001” (disponibles sur le site www.ceag.de).
Les informations utilisateur pour les „MOOG-Ventile“ doivent être respectées.
Seul un personnel qualifié est autorisé à effectuer le branchement électrique des connecteurs mâles-femelles.
Le groupe d'explosion et la classe de température marqués sur les appareils devront être respectés.
Le connecteur n'est pas conçu pour être utilisé dans les atmosphères explosibles des zones 0 et 20, 21, 22 conformément à CEI 60079-10.
Respecter impérativement les valeurs indiquées dans les caractéristiques techniques pour les connecteurs sous charge. Ne séparer qu'à 230 V / 400 V 10 A.
Les prises à bride aux métal et les sockles connecteur aux métal doivent être reliés au même potentiel.
Monter et utiliser le connecteur seulement s'il présente un état technique parfait, conformément à sa destination, en étant conscient des risques et des mesures de sécurité à appliquer dans le respect d es présentes instructions de montage et de service.
Tenir compte des prescriptions nationales en matière de sécurité et de prévention des accidents ainsi que des consignes de sécurité indiquées dans ce mode d'emploi, écrites en italiques comme ce texte!
Après déconnexion, les éléments de connexion encore sous tension doivent immédiatement être protégés à l'aide d'obturateurs.

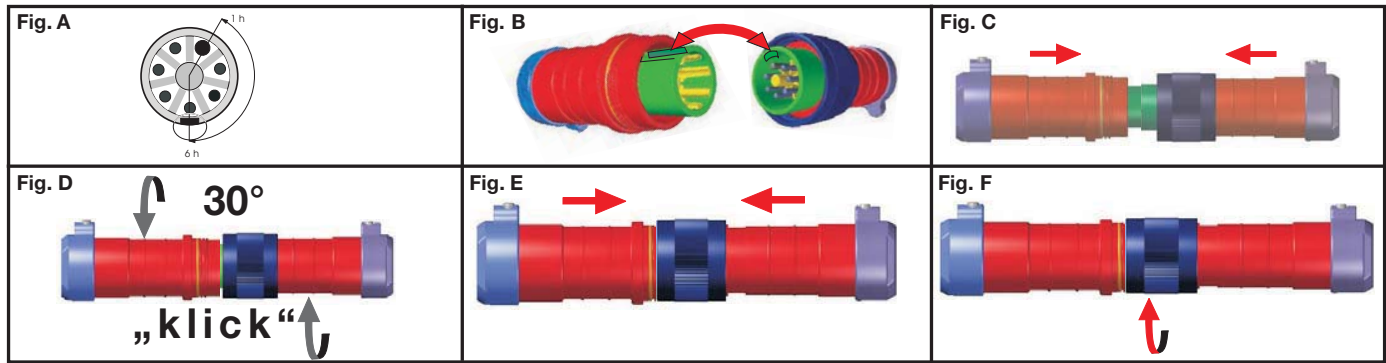

Steckverbindung stecken/trennen

⚠ Die Flanschsteckdosen und Gerätestecker nur mit den zugehörigen unbeschädigten Steckern und Kupplungen betreiben.

⚠ Auf gleiche Codierung (Uhrzeit) der Steckverbindung achten.

i Der Winkel zwischen Führungsnase und PE Stift (mit größerem Durchmesser) ergibt die Uhrzeit. (Fig. A)

Steckverbindung stecken

1. Der Stecker bzw. Gerätestecker mit der Führungsnase lagerichtig in die entsprechende Führungsnute der Kupplung bzw. Flanschsteckdose stecken. (Fig. B)
2. Bis zum 1. Anschlag zusammenstecken. (Fig. C)
3. Stecker bzw. Gerätestecker gegen Kupplung bzw. Flanschsteckdose ca. 30° gegeneinander bis zum Anschlag verdrehen. (Fig. D)
4. Steckverbindung vollständig zusammenstecken. (Fig. E)

i Die elektrische Verbindung des Stecksystems ist jetzt hergestellt.

5. Überwurfmutter des Steckers andrücken und handfest festschrauben.

⚠ IP Schutz und die mechanische Verbindung hergestellt. (Fig. F)

Steckverbindung trennen

1. Steckverbindung in umgekehrter Reihenfolge zum Stecken trennen.

⚠ Bei nicht korrektem Stecken der Steckverbindungskomponenten ist der Explosionsschutz nicht mehr gewährleistet.

Anschlussleiter von Gerätestecker/Flanschsteckdose vorbereiten

Kabel und Leiter entsprechend den Technischen Daten verwenden.

⚠ Bei mehr- oder feindrähtigen Leitern die Enden entsprechend den geltenden nationalen und internationalen Vorschriften behandeln (z.B. Verwenden von Aderendhülsen).

Die ordnungsgemäß abisolierten Leiter des Kabels unter Berücksichtigung einschlägiger Vorschriften anschließen.

Leiteranschluss zur Aufrechterhaltung der Zündschutzart mit besonderer Sorgfalt durchführen.

Connection/disconnection of plug and socket

⚠ The flange sockets and inlets shall only be operated with the associated, undamaged plugs and couplers.

⚠ Attention shall be paid that the coding (time setting) of the plugs and sockets is the same.

i The time of day is the angle between the guide lug and the PE pin (larger in diameter). (Fig. A)

Connecting plug and socket

1. Insert the plug or inlet with the guide lug in the correct position into the respective keyway of the coupler or flange socket. (Fig. B)
2. Insert until 1st stop is reached. (Fig. C)
3. Turn plug or inlet through ca. 30° in relation to the coupler or flange socket until the stop is reached. (Fig. D)
4. Join plug and socket completely. (Fig. E)

i The electrical connection has now been made.
5. Press the coupling nut of the plug on and screw it tight by hand.

⚠ The IP degree of protection and the mechanical connection are established by tightening the coupling nut. (Fig. F)

Disconnecting plug and socket

1. To disconnect plug and socket, carry out the above actions in the reverse order.

⚠ When opened, the live plug and socket system components shall be sealed immediately after disconnection using the protective cap.

Prepare connection conductors of inlet / flange socket

Only use cables and conductors specified in the Technical Data.

⚠ With multi-wire or fine-wire connection leads, the ends of the wires shall be treated in accordance with the valid national or international regulations (e.g. the use of wire-end ferrules).

The insulation of the conductor shall reach up to the plug pins. The conductor must not be damaged

The relevant regulations shall be observed to ensure that the conductors of the cable are stripped off correctly.

The conductors shall be connected with due care to ensure that the degree of protection is maintained.

Branchement/Débranchement du connecteur

⚠ N'utiliser les prises de courant à bride et les socles connecteurs qu'avec des fiches et prolongateurs compatibles intacts.

⚠ Veiller à un codage identique (heure) du connecteur.

i L'angle entre l'ergot de guidage et le contact mâle PE (d'un plus grand diamètre) donne l'heure. (Fig. A)

Branchement du connecteur

1. Engager dans la bonne position la fiche/le socle connecteur avec l'ergot de guidage dans la rainure de guidage correspondante du prolongateur/de la prise de courant à bride. (Fig. B)
2. Brancher les deux éléments jusqu'à la butée
3. Tourner dans des sens contraires, d'env. 30°, la fiche/le socle connecteur et le prolongateur/la prise de courant à bride jusqu'en butée. (Fig. D)
4. Le connecteur mâle-femelle boucher tout à fait. (Fig. E)

i Le branchement électrique du système de connexion est maintenant réalisé.
5. Appuyer l'écrou-raccord de la fiche et le visser. (Bien serrer à la main).

⚠ Le vissage de l'écrou-raccord a pour effet d'établir la protection IP et la liaison mécanique. (Fig. F)

Débranchement du connecteur

1. Débrancher le connecteur dans l'ordre inverse du branchement.

⚠ Les éléments de connexion conducteurs de tension à l'état ouvert doivent être fermés avec le capuchon dès le débranchement.

Préparation conducteurs de raccordement du socle connecteur / de la prise de courant à bride

Utiliser les câbles et les conducteurs conformément aux Caractéristiques techniques.

⚠ Avec des conducteurs multifilaires ou à fils fins, traiter les extrémités conformément aux directives nationales et internationales (par ex. en utilisant des embouts).

Raccorder les conducteurs correctement isolés du câble en respectant les directives correspondantes.

Effectuer le raccordement du conducteur avec beaucoup de soin pour garantir la protection contre les explosions.

Gerätestecker / Flanschsteckdose einschrauben

! Gerätestecker bzw. Flanschsteckdose nur in die dafür vorgesehene Gehäuse einbauen. Das Gehäusevolumen bei der Auswahl des Gerätesteckers berücksichtigen.

! Die Gewindebohrungen im druckfesten Schutzgehäuse oder Einbaugeräten, müssen den Mindestanforderungen der EN 60079-1, entsprechen.

! Zur Sicherstellung des Explosions-schutzes in die Bohrungen von druckfesten Gehäusen nur Gerätestecker und Flanschsteckdosen aus Metall mit der geeigneten Zündschutzart verwenden.

Die Einschraubgewinde dürfen nicht verschmutzt oder beschädigt sein.

Nur die im Gerätestecker bzw. in der Flanschsteckdose vorhandenen Dichteinsätze verwenden.

Beim Einschrauben der Gerätestecker bzw. der Flanschsteckdosen auf die angeschlossenen Leitungen bzw. Adern achten, damit keine Beschädigung der Isolation durch das Einschrauben entsteht.

! Die Einschraubkomponenten sind so fest einzuschrauben, dass eine korrekte Dichtwirkung gewährleistet ist. (Prüfdrehmoment siehe Technische Daten).

! Die Gerätestecker und Flanschsteckdosen aus Metall in das Erdpotential mit einbeziehen.

Vor dem Stecken sicherstellen, dass Gerätestecker und Flanschsteckdosen nicht beschädigt sind.

1. Gerätestecker bzw. Flanschsteckdose mit Verdrehenschutz einschrauben (Prüfdrehmoment -> Technische Daten).
2. Verdrehenschutzschraube festdrehen.
3. Gerätestecker bzw. Flanschsteckdosen durch kontern sichern.
Den Gerätestecker nicht durch verkleben gegen Lösen sichern, da sonst Funktionsstörungen auftreten können.

Screw in inlet / flange socket

! Inlets or flange sockets shall only be built into enclosures intended for this purpose. Observe the flameproof enclosure volume when flange-socket selecting.

! The threaded holes in the flameproof enclosure shall fulfil the minimum requirements of EN 60079-1.

! To ensure the explosion protection, only fit inlets and flange sockets made of metal in the appropriate type of protection into the threaded holes of flameproof enclosures.

The screw-in thread must not be dirty or damaged.

Only use the seal inserts provided in the inlet or flange socket.

When screwing in the inlet or flange socket, pay attention to the connected conductors to ensure that the insulation is not damaged in the process.

! The screw-in components shall be tightened down in such a way that they are properly sealed (see Technical Data for test torque).

! The inlets and flange sockets shall be incorporated in the earth potential.

Before use, ensure that inlets and flange sockets are not damaged.

1. Fit inlet or flange socket with anti-twist protection, (test torque -> Technical Data).
2. Tighten anti-twist screw.
3. Fit inlet or flange socket with anti-twist protection (7), (test torque -> Technical Data).

Vissage du connecteur / de la prise de courant à bride

! Ne monter le socle connecteur ou la prise de courant à bride que dans les boîtiers prévus à cet effet. Observez le volume de l'enceinte antidéflagrante lors socle connecteur avec sélection.

! Les alésages filetés du boîtier de protection ou appareil à encastrer résistant à la pression doivent satisfaire aux exigences minima de la norme EN 60079-1.

! Pour garantir la protection contre les explosions, n'utiliser dans les orifices des boîtiers résistant à la pression que des socles connecteurs et des prises de courant à bride en métal, présentant le type de protection contre les explosions approprié.

Les filetages ne doivent pas être sales ou endommagés.

N'utiliser que les éléments d'étanchéité disponibles dans le socle connecteur ou la prise de courant à bride.

En vissant le socle connecteur ou la prise de courant à bride sur le câble ou le fil connecté, veiller à ne pas endommager l'isolation.

! Les éléments de vissage doivent être vissés avec un couple assurant une bonne étanchéité. (Couples de contrôle voir les Caractéristiques techniques)

! Intégrer les socles connecteurs et les prises de courant à bride en métal dans le potentiel terrestre.

Avant la connexion, s'assurer que les socles connecteurs et les prises de courant à bride sont en bon état.

1. Visser le socle connecteur ou la prise de courant à bride avec la protection antitorsion (Couples de contrôle -> Caractéristiques techniques).
2. Serrer à fond la vis de protection antitorsion.
3. Bloquer le socle connecteur ou la prise de courant à bride par contre-écrou.
Ne pas coller le socle connecteur pour l'empêcher de se desserrer, cela risquerait d'entraîner des dysfonctionnements.

Gerätestecker mit Anschlussleitung Inlet with connection leads Socle connecteur avec lignes de raccordement

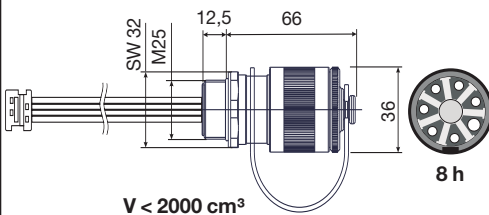

V < 2000 cm³

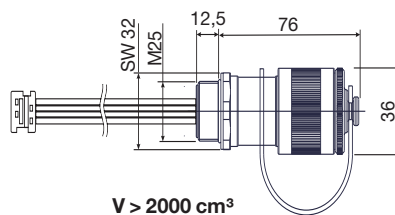

V > 2000 cm³

Flanschsteckdose mit Anschlussleitung Flange socket with connection leads Prise à bride avec lignes de raccordement

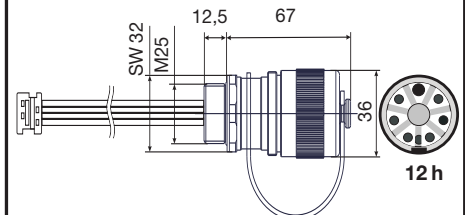

12 h

! Das Gehäusevolumen bei der Auswahl des Gerätesteckers berücksichtigen.

Observe the flameproof enclosure volume when flange-socket selecting.

Observez le volume de l'enceinte antidéflagrante lors socle connecteur avec sélection.

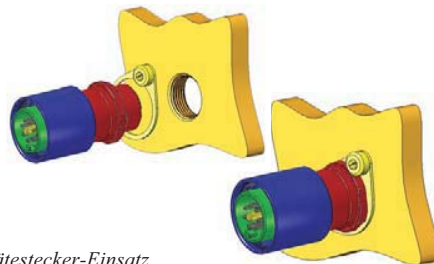

- 1 Überwurfmutter
Ecrou-raccord
Ecrou-raccord
- 2 Gerätestecker-Hülse
Douille du socle connecteur
Douille du socle connecteur
- 3 Anschlusskabel
Câble de raccordement
Câble de raccordement

- 4 Gerätestecker-Einsatz
Bloc de socle connecteur
Bloc de socle connecteur
- 5 Flanschsteckdosen Hülse
Douille de la prise de courant à bride
Douille de la prise de courant à bride
- 6 Flanschsteckdosen-Einsatz
Bloc de prise de courant à bride
Bloc de prise de courant à bride

Normenkonformität

Das Steckverbindingssystem entspricht den in der Konformitätserklärung aufgeführten Normen und den vergleichbaren IEC Standards IEC 60079-0, IEC 60079-1, IEC 60079-7, IEC 61241-0, IEC 61241-1.
CAN/CSA C22.2 E60079-0-02
CAN/CSA C22.2 E60079-1-02
CAN/CSA C22.2 E60079-7-2003
CAN/CSA C22.2 No 213
CAN/CSA C22.2 No 182.3 M1987
CAN/CSA C22.2 No 94.1-07
94/9 EG: Geräte und Schutzsysteme zur bestimmungsgemäßen Verwendung in explosionsgefährdeten Bereichen.
Das Steckverbindingssystem ist gemäß DIN EN ISO 9001 entwickelt, gefertigt und geprüft worden.

Conformity with standards

The plug and socket system is conform to the standards specified in the EC-Declaration of conformity and additional conform to the comparable IEC Standards IEC 60079-0, IEC 60079-1, IEC 60079-7, IEC 61241-0, IEC 61241-1.
CAN/CSA C22.2 E60079-0-02
CAN/CSA C22.2 E60079-1-02
CAN/CSA C22.2 E60079-7-2003
CAN/CSA C22.2 No 213
CAN/CSA C22.2 No 182.3 M1987
CAN/CSA C22.2 No 94.1-07
94/9 EC: Equipment and protective systems intended for use in potentially explosive atmospheres.
It has been designed, manufactured and tested according to the state of the art and to DIN EN ISO 9001.

Conformité avec les normes

Les boîtes à bornes sont conformes aux normes reprises dans la déclaration de conformité et supplémentaires conformes à la comparables aux IEC Standards IEC 60079-0, IEC 60079-1, IEC 60079-7, IEC 61241-0, IEC 61241-1.
CAN/CSA C22.2 E60079-0-02
CAN/CSA C22.2 E60079-1-02
CAN/CSA C22.2 E60079-7-2003
CAN/CSA C22.2 No 213
CAN/CSA C22.2 No 182.3 M1987
CAN/CSA C22.2 No 94.1-07
94/9 CE: Appareils et systèmes de protection destinés à être utilisés en atmosphère explosible.
Les boîtes à bornes ont été conçues, fabriquées et contrôlées suivant DIN EN ISO 9001.

	EG-Konformitätserklärung EC-Declaration of conformity CE-Déclaration de conformité PTB 06 ATEX 1031 X
	GHG 900 1000 P0048 B
Wir / we / nous	Cooper Crouse-Hinds GmbH Neuer Weg-Nord 49 D-69412 Eberbach
erklären in alleiniger Verantwortung, dass die <i>hereby declare in our sole responsibility, that the déclarons de notre seule responsabilité, que le</i>	Mehrfachsteckverbinding eXLink 6-/7-polig <i>multiple plug and socket systems eXLink, 6-/7-pole multiple fiches et prises eXLink, à 6-/7-pôles</i>
II 2 G Ex de IIC T6 // II 2 G Ex ia/ib IIC T6	Typ GHG 57.
auf die sich diese Erklärung bezieht, mit den folgenden Normen oder normativen Dokumenten übereinstimmen. <i>which are the subject of this declaration, are in conformity with the following standards or normative documents. auquel cette déclaration se rapporte, est conforme aux normes ou aux documents normatifs suivants.</i>	
Bestimmungen der Richtlinie Terms of the directive Prescription de la directive	Titel und / oder Nr. sowie Ausgabedatum der Norm. Title and / or No. and date of issue of the standard. Titre et / ou No. ainsi que date d'émission des normes.
94/9/EG: Geräte und Schutzsysteme zur bestimmungsgemäßen Verwendung in explosionsgefährdeten Bereichen.	EN 60 079-0: 2004 EN 60 079-1: 2004 EN 60 079-7: 2004 EN 60 079-11: 2007
94/9/EC: Equipment and protective systems intended for use in potentially explosive atmospheres.	EN 60 529: 1991 + A1: 2000 EN 61 984: 2001 EN 60 999-1: 2000
94/9/CE: Appareils et systèmes de protection destinés à être utilisés en atmosphère explosibles.	
2004/108 EG: Elektromagnetische Verträglichkeit 2004/108 EC: Electromagnetic compatibility 2004/108 CE: Compatibilité électromagnétique	EN 60 947-1: 2007
Eberbach, den 17.09.09	 i.v. 
Ort und Datum Place and date Lieu et date	J.A. Brandel Leiter Labor Head of Laboratory Chef du dépt. Laboratoire
	i.v. Huter Leiter Approval Head of Approval office Chef du dépt. approbation
	PTB 96 ATEX Q 1 - 5
Zertifizierungsstelle Notified Body of the certification Organes Notifié et Compétent	Physikalisch-Technische Bundesanstalt (0102) Bundesallee 100 D-38116 Braunschweig
Konformitätsbewertungsstelle Notified Body to quality evaluation Organes d'attestation de conformité	Physikalisch-Technische Bundesanstalt (0102) Bundesallee 100 D-38116 Braunschweig
Für den sicheren Betrieb des Betriebsmittels sind die Angaben der zugehörigen Betriebsanleitung zu beachten. <i>For the safe use of this apparatus, the informations given in the accompanying operating instructions must be followed. Afin d'assurer le bon fonctionnement de nos appareils, prière de respecter les directives du mode d'emploi correspondant à ceux-ci.</i>	
	

Cooper Crouse-Hinds GmbH

Neuer Weg-Nord 49
D-69412 Eberbach
Phone +49 (0) 6271/806-500
Fax +49 (0) 6271/806-476
Internet: www.CEAG.de
E-Mail: info-ex@ceag.de

TAKE A CLOSER LOOK.

Moog designs a range of products that complement the performance of those featured in this document. Visit our website for more information and the Moog facility nearest you.

Argentina
+54 11 4326 5916
info.argentina@moog.com

India
+91 80 4057 6605
info.india@moog.com

Singapore
+65 677 36238
info.singapore@moog.com

Australia
+61 3 9561 6044
info.australia@moog.com

Ireland
+353 21 451 9000
info.ireland@moog.com

South Africa
+27 12 653 6768
info.southafrica@moog.com

Brazil
+55 11 3572 0400
info.brazil@moog.com

Italy
+39 0332 421 111
info.italy@moog.com

Spain
+34 902 133 240
info.spain@moog.com

Canada
+1 716 652 2000
info.canada@moog.com

Japan
+81 46 355 3767
info.japan@moog.com

Sweden
+46 31 680 060
info.sweden@moog.com

China
+86 21 2893 1600
info.china@moog.com

Korea
+82 31 764 6711
info.korea@moog.com

Switzerland
+41 71 394 5010
info.switzerland@moog.com

Finland
+358 10 422 1840
info.finland@moog.com

Luxembourg
+352 40 46 401
info.luxembourg@moog.com

United Kingdom
+44 168 429 6600
info.uk@moog.com

France
+33 1 4560 7000
info.france@moog.com

Netherlands
+31 252 462 000
info.thenetherlands@moog.com

USA
+1 716 652 2000
info.usa@moog.com

Germany
+49 7031 622 0
info.germany@moog.com

Norway
+47 6494 1948
info.norway@moog.com

Hong Kong
+852 2 635 3200
info.hongkong@moog.com

Russia
+7 8 31 713 1811
info.russia@moog.com

www.moog.com/industrial

Moog is a registered trademark of Moog Inc. and its subsidiaries. All trademarks as indicated herein are the property of Moog Inc. and its subsidiaries.
© 2012 Moog GmbH. All rights reserved. All changes reserved.

Pilot-operated proportional valves D67xK
reinisch/Rev. -, May 2012, CDS29588-en